

SUOMEN MUINAISMUISTOYHDISTYKSEN AIKAKAUSKIRJA
FINSKA FORNMINNESFÖRENINGENS TIDSKRIFT
105:2

THE FINNISH NUBIA EXPEDITION
TO SUDANESE NUBIA 1964–65
THE EXCAVATION REPORTS

Volume II
Plates

GUSTAF DONNER

HELSINKI 1998

Front cover. Aerial view of the concession
area of the Finnish Nubia Expedition from
Gemai Plain in the north to Nag Sigaga Plain
in the south.

Toimittaja – Redaktör – Editor:
Torsten Edgren

Editorial secretary
Ritva Hakkarainen

ISBN 951-9057-29-3
ISSN 0355-1822

Vammala 1998
Vammalan Kirjapaino Oy

THE FINNISH NUBIA EXPEDITION
TO SUDANESE NUBIA 1964–65

The Excavation Reports

VOLUME II
Plates

LIST OF ILLUSTRATIONS	7
PLATES 1–219	11

LIST OF ILLUSTRATIONS

1. Map of the Egypt and Nubia.
2. Map of Lower Nubia.
3. Map of the FNE Concession Area with the Sites.
4. Site 1. Plan.
5. Site 1/1–4. Plan. 1/1,3.
6. 1. View over the site 1, in the foreground graves 1–4, from SE. 2. Bone heap in 1/1. 3–5. Sealing and a body in the shaft (1/3).
7. Site 2. Plan, excavated areas I, II, III.
8. Site 2/2,3,9,15–17,19.
9. Site 2/21–24,26,28,29,35,38.
10. Site 2/39–41,43,47,50,53,55,59.
11. Site 2/51,54,64–6,7,69.
12. Site 2/68,70–73,75.
13. Site 2/77,80–83,89.
14. Site 2/86,87,90,92,93,95–98.
15. Site 2/99–100,102–105.
16. Site 2/108,110,111,113,115,116,118.
17. Site 2/121,123,125–129,131.
18. Site 2/130,132–134,136,139–141.
19. Site 2/142,145–147,147A,149,150,153,157,158.
20. Site 2/154,154A,170,163,168,178,181,186,193,197,205.
21. Site 2/204,206,207,214–217,223.
22. Site 2. 1. Aerial view. 2. View over parts I and II from S–SE. 3. View over parts II and III from N. 4. Sealing (2/95). 5. Sealing and a niche (2/49).
23. 1–2. Sealings (2/107,193). 3–4. Sealing and a body of X-group in the shaft (2/130-3). 5. Child body in the NE-corner (2/130-1). 6. A body of Christian in the shaft (2/130-2).
24. 1–2. 2/154A:3 pottery in situ and a body in the shaft. 3–6. Sealing and a body in the shaft (2/163). 5–6. Body in the shaft (2/80,104).
25. 1–2. Body in the shaft (2/139,147A). 3–6. Pottery in situ (2/80:1,83:1,3;136:1;69:2,3).
26. Site 3. Plan.
27. Site 3. View over the site, from S. 2. Before excavation, from W. 3. Detail, from E.
28. Site 4. Plan.
29. Site 4. The vault construction.
30. Site 4. 1. Aerial view. 2. View towards SE–SSE–S. 3. View to NE. 4. View to S.
31. Site 4. 1. (left to right) room 31 and room 32 E and N walls. 2. View (left to right) to rooms 14,29,25&10. 3. Room 14, S-wall. 4. Room 10, N-wall.
32. Site 4. 1–2. Room 15 N-wall and E-part. 3. The door between rooms 15&16. 4. Room 21, from N. 5. Room 27, from NE. 6. Passage-wall between rooms 46&47, from NE.
33. Site 5 and 5 West. Plan.
34. Site 5/1–5,7,8.
35. Site 5/6,9–14.
36. Site 5/15,20–26,28.
37. Site 5/29,30,32,35–37.
38. Site 5/38–40,42–44.
39. Site 5. 1. Under the excavation, from NE. 2. Vault and a niche from E (5/2). 3. Niche and bodies in the shaft, from W (5/15). 4. Upper sealing (5/13). 5. Sealing and a body in the shaft, from SE (5/12). 6. Body and finds in situ (5/40:1–3).
40. 1–2. Sealing and pottery in situ, from S (5/22:1,2). 3–4. Sealings, shift 1 and 10 (5/29). 5–6. Finds in situ (5/29:2,1).
41. Site 6. Plan.
42. Site 6/1–6.
43. Site 6/7–8.
44. Site 6/9a,b.
45. Site 6/10–12.
46. Site 6. Graves B and C and structure of the mound H.
47. 1–2. Sealing and pottery in situ (5/39:3,4). 3. View over the site 6. 4. Sealing, 2nd layer (6/3). 5–6. Body in the shaft and a detail of the rug (6/4).
48. 1–2. Tumulus, from N and pottery in situ (6/7:1,2). 3. Tumulus, from NW (6/8). 4. Sealing (6/9a). 5. Traces of tumulus (6/10). 6. Tumulus H, E from the site (6/H).
49. Site 8. Plan.
50. Site 8. Profile plan.
51. Site 8. The terrace I.
52. 1. Site 6, the middle stone of tumulus H, from W. 2–3. View from N of the site 8 and the “hut bottom” on the mountain top, from W. 4. Site 9, from S. 5. Site 10, after the excavation, from S. 6. Body in the shaft (10/10B).
53. Site 9. Plan. Hut bottoms 1 and 2.
54. Site 10. General plan and 10/1,2. Site 12. Topo sketch.
55. Site 14. Sheikh Suleiman. Plan.
56. Site 14/1.
57. Site 14/2.
58. Site 14/3.
59. Site 14/3. S,E,N and W façades.
60. Site 14/3. Sheikh Suleiman grave.
61. 1. Site 12, from SE. 2. Site 14, view from the mountain top in SE. 3. 14/1 from N (excavated by Mills). 4–5. Superstructure, N-wall from inside (14/2). 6. Sealing (14/2).
62. 1–2. Superstructure, from N and SE (14/3). 3. Vault under the superstructure, from N (14/3). 4. Bodies in the W-end (14/3). 5. Site 15. New Kingdom part, from N, pit B in the foreground. 6. Burial: a dog and a turtle (15/4).
63. Site 15. Plan of the New Kingdom cemetery and habitation site & the Mesolithic habitation site.
64. Site 15. Profile plan from the cemetery area.
65. Site 15/1–3.
66. Site 15/4–6.
67. Site 15/7,8.
68. Site 15/9.

69. Site 15. Plan of the New Kingdom habitation site: pits A–D, I–II & “tumulus”.
70. Site 15. Profile plan x–y from the New Kingdom habitation site.
71. Site 15. House pits A and B.
72. Site 15. Pits A, I and II.
73. 1–2. Superstructure and a body in the shaft (15/5). 3. Body in the shaft (15/6). 4. A ‘creek’, E of 15/9. 5. “Pottery heap”. 6. Pit C, detail of the wall, from SE.
74. 1. Site 15, tumulus, excavated, from N. 2. 150m SE of the site 15, pottery in situ. 3. Site 17, the W-part. 4–6. Superstructure, a sealing before opening and a body in the shaft (17/2).
75. Site 17/1,2. Plan.
76. Sites 19/1–3 and 20/1–2. Plan.
77. 1–2. 19 and 19/1. 3–4. 20/1 after the excavation and 20/2 before the excavation. 5–6. Site 21 from N and the house 21/12.
78. Site 21 and site 23. Plan.
79. Sites 21:3 and 23:1–4,9.
80. 1. Site 24, from S. 2. Site 24, superstructure. 3. Site 23 under the excavation, from W. 4. 23/3,4 emptied from SE. 5. 23/01 in situ.
81. Site 28. General plan.
82. Site 28. Profile plan A–D.
83. Site 28. Plan of the house I.
84. Site 28. Profile plan of the house II.
85. 1. Site 27, from WSW. 2. Site 28, from SE. 3. House 28/2, rooms A&B, from SSW. 4. 28/2, hearth in room A, from W. 5. 28/1, from NW. 6. 28/1, N-wall from inside.
86. Site 29. Plan.
87. Site 29/1–4.
88. Site 29/10,12,14. Plan.
89. Site 29/5–8.
90. Site 29/9–12.
91. Site 29/13–16.
92. 1. Site 29, aerial view. 2. Sealing (29/1). 3. Emptied, from E. 4. Emptied, from S (29/3,4). 5. 29/3:2 in situ. 6. 29/5&16, excavated.
93. 1. 29/5:1,2 in situ. 2–4. 29/9 before excavation, from NW, sealing and a body in the shaft. 5. Sealing, from NE (29/11). 6. The “wall” possible made by robbers plundering grave 6, sherds embedded in the “wall”.
94. 1. 29/12:2,3 in situ. 2. Bones and pottery in situ (29/14:2,3). 3. Site 30, from E. 4. Site 30, under excavation. 5. Before excavation, from S (30/1). 6. 30/2:1–3 in situ.
95. Site 30. Plan.
96. Site 30/1,3,4,6.
97. Site 30A. A-group layers BIV–BV. Graves 30/1,2.
98. Site 30A/5, 30/5,7,8.
99. Site 30/9–12.
100. Site 30/13–16.
101. Site 30/17–19.
102. Site 30/20–23.
103. View over Nag Sigaga Plain.
104. 1. Silo and a body in the shaft (30/4). 2. Body and pottery in the shaft (30/11:1). 3–4. Sealing and pottery in situ (30/16:1). 5–6. Before excavation, from S and a body in the shaft (30/17).
105. 1. Body in the shaft (30/22). 2. CII:01 in situ. 3–4. Site 30A, from E and S. 5. A-group sherds in the shaft wall (30/1).
106. Site 31. Topo sketch.
107. Site 31/1–2.
108. Site 32. Plan.
109. Site 32/2,3.
110. Site 32/4,6,7.
111. Site 32/8–13.
112. Site 32/14,16–19.
113. 1. Body in the shaft (31/2). 2. Site 32, from N. 3. Body in the shaft, from S (32/17). 4. Site 33b, from the rock in SE. 5. Wadi connecting the sites 33a and 33b, from NW. 6. Site 33a, from W. 7. Hut g, from W (33a).
114. Sites 33a and 33b. Plan.
115. Site 33a. Plan.
116. Site 33a. Hut bottoms g,j,o,v.
117. Site 33b. Plan.
118. Site 33b. Profile plan A–B.
119. Site 33b. Profile plan.
120. Site 34. Plan.
121. Site 34. General plan and profile plans of the habitation area.
122. Site 36/I–VI. Plan.
123. Site 36. Pits I–VI.
124. 1. Site 34, excavated, from W. 2. Site 36, excavated, from NW. 3. 36/VI, stones on the pit, from E. 4. Site 38, survey to S. 5. Site 38, from N. 6. Site 38, N-part, from S. 7. Emptied (38/31).
125. 1–2. Sealing and a (child) body in the shaft (38/21). 3. Site 39, under excavation. 4. Sealing and a niche, from W (39/11). 5. Sealing (39/39). 6. Sealing (39/43) and a body in the shaft (39/43A).
126. Site 38. Plan.
127. Site 38/1,2,6,7,13,14,18,19.
128. Site 38/21,24,26,28,31,32,36,38,39.
129. Site 39. Plan.
130. Site 39/1,2,3,8,9,22,27,33.
131. Site 39/10,38,39.
132. Site 39/43,44,48,48A,48B,49.
133. Site 39/53,55,58,62,64,69.
134. Site 39/67,74,75,77,80,82,84,86.
135. Site 39/90,91,93,94,101,104,105.
136. Site 39/106,114,119,126.
137. Site 39/116,128,129,131.
138. Site 39/134,136,139–141,144,146.
139. Site 39/147,148,154–156.
140. Site 40. Plan.
141. Site 40/1,2,4,5,7,8.
142. Site 40/10,11,14,15,17,18.
143. Site 40/19,20,24–28.
144. Site 40/32,34–37.
145. 1. Site 40, under excavation, from W. 2. Body in the shaft (40/35). 3. Disturbed burial (40/14). 4. Body in the shaft (40/19). 5–6. Sealing and a (child) body in the shaft (40/2).
146. Site 41. Plan. 41/1–5.
147. Site 41/6–8.
148. Site 43. Plan.
149. Site 43. Find groups 1–6.
150. 1. Survey of the site 41. 2. Site 42, from N. 3. Site 43, under excavation. 4. Old silt bank SE of the site 43. 5. Knife in situ (43/EVI). 6. Site 44, from S.

151. Site 45. Plan.
152. Site 45/1,2.
153. 1–2. Sealing and a stone chist and a leatherwrap (44/3). 3. Site 45, from W. 4–5. Sealing and a body in the shaft (45/3).
154. Site 2. Ceramic repertoire. Cups: Classic X-group red ware, NII/R1.
155. Site 2. Ceramic repertoire. Goblets: Classic X-group red ware, NII/R1, nos. 44:1,54:3,69:3;104:1,2;145:2. Early X-group brown ware, Egyptian made specimen, T/R25, nos. 73:3,105:1,133:2,157:1. Aswan Graeco-Roman ordinary red ware, AI/R30, no. 186:2.
156. Site 2. Ceramic repertoire. Footed bowls: Classic X-group red ware, NII/R1, nos. 89:1;140:1,3;157:2,202:3. Bowl 158:1. Pots: Early Christ. brown utility ware, NU/U1, no. 59:2. Early domestic plain utility ware, DI/H1, no. 69:2. DI or DII/H1, nos. 73:2,4. Transitional red ware, NII/R2, no. 105:5.
157. Site 2. Ceramic repertoire. Pots: Earlier Christ. red-topped domestic ware, DI and DII/H2, no. 66:3. Classic X-group red ware, NII/R1, no. 133:1. Early domestic plain utility ware, DI/H1, no. 147A:3. Earlier Christ. red domestic ware, DII/H3, no. 154A:3. Meroitic burnished domestic ware, DI/H9, no. 204:3. Lamp: Meroitic ordinary red ware, NI/R32, no. 105:4. Beaker: DI/H1, no. 83:4.
158. Site 2. Bottles: Classic X-group red ware, NII/R1, nos. 35:1;66:2,4;81:1,145:1,154A:2. Early X-group brown ware, Egyptian made specimen, T/R25, no. 136A:1. T/R25 or W28, no. 147A:6. Pitcher: Transitional red ware, NII/R2, no. 147A:5. Lekythos: AI/R30(M13), no. 80:1.
159. Site 2. Ceramic repertoire. Amphorae: Middle Egyptian plain utility white ware, T/W28, no. 83:1. Classic X-group red ware, NII/R1, no. 147A:4. T/W21, no. 204:2. Early X-group brown ware, T/R25 or R1, no. 217:4.
160. Site 2. Ceramic repertoire. Qaduses: Pre-Christ. brown utility ware, NU/U1, nos. 33:1,89:2,105:2,139:2,202:2. Christ. red utility ware, NU/U5, no. 223:1.
161. Site 4. Ceramic repertoire. Pots: Later Christ. slipped utility ware, NU/U14, no. 2:2. Later Christ. pink utility NU/U10, no. 3:1. Later domestic plain utility ware, DIII/H4, no. 9:3. Aswan Medieval white ware, AIV/W12, no. 17:01. Qaduses: Christ. red utility ware, NU/U5, nos. 3:8,9;4.
162. Site 4. Ceramic repertoire. Jars: Christ. red utility ware, NU/U5, no. 3:7. Later Christ. pink utility ware, NU/U10, no. 7:2. Later Christ. red domestic ware, DIII/H5, no. 29:1. Goblet: Terminal Christ. polished orange ware, NVII/R26, no. 10:1.
163. Site 4. Ceramic repertoire. Pilgrim bottle: Aswan Islamic plain red ware, AIV?, R13? no. 45:1.
164. Site 5. Ceramic repertoire. Goblets: Early X-group brown utility ware, T/R25, no. 39:3. Classic X-group red ware, NII/R1, nos. 39:6,40:3. Lekythoses: Aswan Graeco-Roman flaky pink ware, AI/R31, nos. 39:2,5. Amphorae: Aswan Graeco-Roman ordinary red ware, AI/R30, no. 35:1. Middle Egyptian plain white ware, T/W28, no. 43:1. Qadus: Pre-Christ. brown utility ware, NU/U1, no. 39:4.
165. Site 6. Ceramic repertoire. Cups: Early Christ. matte white ware, NIII/W2, nos. 8:3,4,6;10:2. Bowls: NIII/W2, nos. 12:3,4;13:1. Footed bowl: NIII/W2, no. 7:2. NII/W2?, no. 9:1. Early Christ. polished red ware, NIII/R5, no. 6:1. Bottles: NIII/W2, no. 8:5. Transitional red ware, NIII/R2, nos. 8:7(?),10:3,12:1,2. Earlier Christ. red domestic ware? DIII/H3? no. 9:2.
166. Site 15. Ceramic repertoire. Necked jars: uncoat. brown, coarse ware W1.01, no. B:1. Brown, coarse red-coat. ware W1.11, no. B:2. Plates: W1.01, no. B:3. Brown, red-coat. and polished ware W1.13, no. II/5. Bowl: W1.01, no. 3:1. Lamp: Early Christ. matte white ware, NII or NIII/W2 or W6, no. T/05. Site 19–20. Bowl: NIII/W2, no. 019.
167. Site 29. Ceramic repertoire. Bowls: uncoat. brown ware, H1.01A, no. 08. Uncoat. brown ware, interior black, H1.01B, nos. 11:02;07. Red-coat. plain polished ware. H2.11, no. 10:1. Ware H4.11, no. 12:5. Black-topped red-coat. variant, H4.11C, nos. 11:01,13:1. Black-topped Pangrave-ware, H4.11F, nos. 1:1,3:1;5:2,3;01.
168. Site 29. Ceramic repertoire. Bowls: black-mouth. red ware, H4.11D, nos.3:2,6;02,7;03;11:03,04;12:1;14:1,5; 04,06.
169. Site 29. Ceramic repertoire. Beakers: red-and-black Kerma ware, H4.15, nos. 1:3;7:1,2;12:2,3,4,6;14:7.
170. Site 29. Ceramic repertoire. Jars: uncoat. brown ware, rim-top black. H1.01B, no. 14:3. Polished brown ware, H2.01C, no. 5:1. Plain red-polished ware with uncomp. int. H2.13, nos. 1:2, 14:2. Wheelmade wares: uncoat. brown, coarse ware, W1.01, no. 9:2. Uncoat. brown ware with polished exterior, W1.02, no. 6:2. Brown, coarse red-coat. ware, W1.11A, no. 6:4. Hard, pink slip-ware with polished exterior, W3.22, no. 14:8.
171. Site 30. Ceramic repertoire. Bowls: plain, polished black-and-red ware, H4.11, nos. 20:8b,10,11;23:2,01,08c; CII:01,BIII:01,CIII:08a,GIII:02.
172. Site 30. Ceramic repertoire. Bowls: thin-walled variant, H4.11A, nos. 2:1,2,3. Plain polished brown-and-black ware, H4.01, nos. 20:8a,DIV:01. Incised decor. wares, H3.03, nos. 7:01,16:1,17:5a. Plain, polished black ware, H3.01 no. GIII:01. Uncoat. brown ware, H1.01B, no. 15:1. Plain polished red-and-black ware with uncomp. int., H4.13, no. DII:01.
173. Site 30. Ceramic repertoire. Jars: wheelmade wares, hard, unpolished Qena ware, W5.01, nos. 11:1,FIII:01. Black, unpolished ware, W2.01, no. 23:1. Handmade plain, red-polished ware with uncomp. int. H2.13, no. 16:2. Bottle: hard, pink, unpolished slip-ware, W3.21, no. 9:1.
174. Site 32. Ceramic repertoire. Plates: brown, red-coat. ware with polished int. W1.14, nos. 10:5,11:3. Bowls: W1.14, nos. 4:4,7;2,9:1. Brown, uncoat. coarse ware, W1.01, nos. 6:1,17:1. Uncoated, smooth brown ware, H1.01, no. 10:2. Polished, red-and-black ware, H4.11D, no. 19:2. Beaker: red-and-black Kerma-beaker, H4.15, no. 4:2.
175. Site 32. Ceramic repertoire. Jars: brown, red-coat. ware with polish. ext., W1.12, no. 4:1. Hard, pink slip-ware with polish. ext., W3.22, no. 6:2. Brown, uncoat. ware with polish. ext., W1.02, nos. 10:4,7;4. Hard, red-coat. pink ware with polish. ext., W3.12, no. 7:3a. Brown, uncoat. coarse ware, W1.01, no. 4:3. Brown, coarse red-coat. ware, W1.11, no. 10:1. Lid: uncoat. smooth brown ware, H4.01, no. 7:3b. Jug: W1.11, no. 11:1.
176. Site 39. Ceramic repertoire. Beakers: Meroitic burnished domestic ware, DI/H9, no. 4:1. Meroitic fine black domestic ware, DI/H11, nos. 119:4,5. Bowls: DI/H9, nos. 2:3, 15:2,38:1. Pot: DI/H9, no. 28:1. Early domestic plain utility ware, DI/H1, nos. 59:1,101:3a. Meroitic ordinary white ware, NI/W25, no. 17:1. Wheelmade, hard, unpolished Qena-ware, W5.01, no. 100:1. Plates: wheelmade, brown, coarse, red-coated ware, W1.11, nos. 141:1,2,3,6a.
177. Site 39. Ceramic repertoire. Jars: Meroitic burnished domestic ware, DI/H9, no. 103:1. Meroitic fine black domestic ware, DI/H11, nos. 119:3,47:2. Aswan Graeco-Roman ordinary red ware, AI/R30, no. 119:2. Cups: DI/H9, nos. 19:1,27:1. AI/R30, no. 113:4. Meroitic fine white ware, M/W26, no. 106:5.
178. Site 39. Ceramic repertoire. Bottles: Meroitic ordinary white ware, NI/W25, no. 106:4. Meroitic ordinary red ware, NI/R32, no. 106:2. Amphora: Aswan Graeco-Roman ordinary red ware, AI/R30, no. 116:2. Lekythoses: Meroitic ordinary white ware, M or NI/W25 or 26, no. 106:1. (in Khartoum). AIV/R30(?), no. 2:1.
179. Site 39. Ceramic repertoire. Jug: AIV/R30(?), no. 1:1. Pitcher: Aswan Graeco-Roman ordinary red ware, AI/R30, nos. 116:1 (in Khartoum), 114:2. Pre-Meroitic: bowls: nos. 2:2,48:1,141:10. Cup: no 10:1. Jars: nos. 136:1, 104:1. Pharaonic: jar: no. 104:2.
180. Site 40. Ceramic repertoire. Bowls: Plain polished red-and-black ware with black-topped variant H4.11C, nos. 2:1,3. The ext. black-top confined to a narrow band separated from the body by an incised groove, H4.11F, nos. 19:1,34:1. With black-mouthed variant, H4.11D, nos. 35:1,2. Kerma-beaker, H4.15, no. 36:1. Qaduses: Early Christ. brown utility ware, NU/U1, nos. 11:1,29:1.

181. Site 40. Ceramic repertoire. Jars: brown, red-coated ware with polished ext., W1.12, no. 2:2. Uncoated brown, coarse ware, W1.01, nos. 2:4,5,8:3. Brown, red-coated ware with polished ext., W1.12B, no. 19:2. Earlier Christ. red-topped domestic ware, DII/H2, no. 29:2.
182. Goblets. NII/R1. 1–7. 2/145:2,69:3,104:2, 11-I-4/1:1, 54:3,44:1,104:1. T/R25. 8–11. 2/73:3,105:1,133:2,157:1. AI/R30. 12. 2/186:2. Footed bowls. NII/R1. 13–15. 2/140:1,3;157:2. 16. Bowl. 2/158:1.
183. Cups. NII/R1. 1–8. 2/35:2,54:1,81:2,83:3,104:3,150:1, 147A:2,7a. Pots. NII/R2. 9. 2/105:5. NU/U1. 10. 2/59:2. DI/H1. 11–13. 2/69:2,147:3,73:2. DI/H2. 14. 2/66:3. DII/H3. 15. 2/154A:3. DI/H9. 16. 2/204:3.
184. Bottles. NII/R1. 1–6. 2/35:1,66:2,4;81:1,145:1,154A:2. T/R25. 7–8. 2/136A:1,147A:6. NII/R2. 9. 2/147A:5. 10. Bronze bowl, X-group (2/205:2, in Khartoum).
185. Pottery. 1. 11-I-4/5:1,1,3,1,2:1.1. Lekythos. AI/R30. 2. 2/80:1. Amphorae. T/R25. 3. 2/217:4. T/W21. 4. 204:2. NII/R1. 5. 2/147A:4. Qaduses. NU/U1. 6–7. 2/202:2,105:2. NU/U5. 8. 2/223:1.
186. Pots. NU/U14. 1. 4/2:2. NU/U10. 2–3. 4/3:1,20a:1. DIII/H4. 4. 4/15:1. DII/H2. 5–6. 4/30:1,3:2. Lamp. DIII/H4. 7. 4/15:2. Pilgrim bottle. 8. 4/45:1.
187. Jars. NU/U5. 1. 4/38:1. 2–3. 4/3:7. 4. 4/3:6. NU/U10. 5–7. 4/7:4,18:1,7:2. DIII/H5. 8. 4/29:1. Qadus. NU/U5. 9–11. 4/3:8,3,4,075.
188. Goblets. NII/R1. 1–2. 5/39:6,40:3. T/R25. 3. 5/39:3. Bowls. NII/R1. 4–5. 5/37:1,40:2. Cup. NII/R1. 6. 5/40:1. Pot. NII/R1. 7. 5/29:14. Bottles. NII/R1. 8. 5/22:1. NI/R32. 9. 5/6:2. Lekythos. AI/R30. 10–11. 5/39:2,5. Amphorae. T/W28. 12. 5/43:1. AI/R30. 13. 5/35:1. 11-D-7/2:1. Qadus. NU/U1. 14. 5/39:4.
189. Bowls. 1–3. 11-D-4/3:4–6. NIII/W2. 4–8. 6/7:2,9:1,13:1; 12:4,3. Cups. NIII/W2. 9–11. 6/8:4,3,6;10:2.
190. Bottles. 1–3. 11-D4/3:3,1,2. DII/H9. 4. 6/9:2. NIII/W2. 5. 6/8:5. NII/R2. 6–9. 6/8:7,12:2,1;10:3.
191. Bowls. H1.01B. 1. 29/11:02. H2.01C. 2. 29/4:02. H4.11. 3. 29/12:5. H4.11C. 4. 29/11:01. H4.11D. 5–10. 29/3:2,14:1, 7:03,14:5,06;12:1. H4.11F. 11–15. 29/1:1,5:3,2,01;3:1. Cup. H1.01B. 16. 29/07.
192. Beakers. H4.15. 1–8. 29/7:1,1,3,7:2,14:7;12:6,2,3,4. Jars. H2.13. 9–10. 29/14:2,1,2. H1.01B. 11. 29/14:3. H2.01C. 12. 29/5:1. W1.01. 13. 29/9:2. W1.11A. 14. 29/6:4. W3.22. 15. 29/14:8.
193. Bowls. H1.01B. 1. 30/15:1. H3.03. 2. 30/16:1. H4.01. 3. 30/DIV:01. H4.11. 4–6. 30/BIII:01,CII:01,23:2. H4.11A. 7–9. 30/2:3,2,1. Bottle. W3.21. 10. 30/9:1. Jars. H2.13. 11. 30/16:2. W5.01. 12–13. 30/FIII:01,11:1.
194. Beaker. H4.15. 1. 32/4:2. Bowls. H1.01B. 2. 32/10:2. W1.01. 3. 32/17:1. H4.11D. 4. 32/19:2. W1.01. 5. 32/6:1. W1.14. 6–10. 32/9:1,4,4,11:3,4 (in Khartoum), 7:2. Jars. W1.12. 11. 32/4:1. W1.02. 12,14. 32/10:4,7:4. W1.11. 13,16. 32/10:1,11:1. W1.01. 15. 32/4:3. W3.12. 17. 32/7:3a,b. W3.22. 18. 32/6:2a,b.
195. Bowls. Pre-Meroitic. 1. 39/48:1. DI/H9. 2. 39/2:3. Beaker. DI/H9. 3. 39/4:1. Cups. Pre-Meroitic. 4. 39/10:1. M/W26. 5. 39/106:5. Bottles. NI/W25. 6–7. 39/106:4. NI/R32. 8. 39/106:2. Jars. Pre-Meroitic. 9–10. 39/104:1, 136:1. DI/H11. 11. 39/119:3. AI/R30. 12. 39/119:2. Pharaonic? 13. 39/104:2. Lekythos. AIV/R30. 14. 39/2:1. Jug. AIV/R30. 15. 39/1:1. Amphora. AI/R30. 16. 39/116:2.
196. Bowls. H4.11C. 1. 40/2:3. H4.11D. 2–3. 40/35:1–2. H4.11F. 4–5. 40/19:1,34:1. Jars. H1.01B. 7. 40/8:3. W1.12B. 6,8. 40/19:2,2:2. DII/H2. 9. 40/29:2.
197. Bowl. H4.11D. 1. 44/2:1. Jars. W3.21. 2–3. 44/2:2,3:1. Kohl-pot. 4. 44/2:3.
198. 1. Base knob (4/075). 2–3. Sherds. Decoration motifs of C-group pottery. 4. Kerma-beakers. 5. Sherds of painted jar of NK type (15/10). 6. Pre-Meroitic jar (39/136:1).
199. Sherds. 1–2. Early-Khartoum. K1.01 (43). 3. Es-Shaheinab decoration in A-group pottery (43). 4–6. Incised decoration motifs of C-group pottery.
200. Sherds from Christian period (sites 1,4,8,28).
201. 1. Glass sherds 4/010–012. 2. Seal and a smink-jar 4/8:1, 40/10:6. 3. A clay bell 1/01. 4. Jetons 2/154A:15,11.
202. 1. Grinders 43/FVI:3, FVII:f:1. 2. Clubs 4/01,3:10, 30/DIV:02, 4/30:3. 3. Tool? Soapstone 4/018,019. 4. Flakes 30A/IV:II:1. 5. Arrowhead, flint 32/7:01. 6. Bone tool (30A/AV:I:1).
203. 1. Iron spoon 39/114:4. 2. Bronze hook 29/14:4. 3,5. Axes and a knife 39/80:3,1,2,4. 4. Hoes 2/204:4,5.
204. 1. Arrowheads, hoe, saw, knives 2/206:2,3;217:2,39:3,4. 2. Knives and arrowheads 2/216:2,3,5. 3–4. Arrowheads 2/214:2,3;204:6.
205. 1–2. Necklaces and bracelets (2/202; 5/23; 39/33,141; 40/35). 3. Scarabs (5/29:10; 32/7:5a; 2/145:5; 4/9:2a; 41/1:1; 39/48:9). 4. Earrings (2/202:4; 32/10:3b), bracelet (39/81:1b), plate (39/5:1), tool? soapstone (4/03). 5. Anklets (5/29:1,13), hoe and arrowheads (2/204:4,6).
206. Necklaces. 1. 39/33:1,119:6,126:1,141:4. 2. 5/40:4,13:1. 3. 40/35:6,3. 32/7:5.
207. 1. Bracelets (5/23:3,5,6b,6c). 2–3. Buttons and pendants (5/3:1; 29/6:6a; 32/10:6; 39/5:1,31:1,114:3a,5; 40/35:5; 41/7:4).
208. 1. Earring, pendants, plates and beads. 2. Ring beads (2/154A:1r). 3. Scarab beads (39/114:2a,b,c,3z).
209. 1. Scarab 32/7:1. 2. Pendant 32/19:1. 3. Dice 2/154A:4, pendant fish 44/2:4. 4. Smink-stick 39/113:1,114:3ö. 5. Bronze coin, Abdul Megid 1255 AH, 1/0121. 6. Beans, date stone and date 4/46–47:1.
210. Anklets and a bracelet (ivory) 1–3. 5/29:13; 39/64:2; 5/29:1,39:10; 40/30:1; 30/22:1; 39/64:1. 4. Toerings 5/39:8–9. 5. Bracelet and rings 39/81:1b; 2/154A:7,139:5.
211. Fragments of textiles. 1. A polychrome textile wrap (15/2:1). 2. A detail 15/2:1. 3. Linen garment or mat (39/48A:5). 4–5. Coarse, brown, linen shroud (5/12:1, 15:2). 6. Shroud (1/1:1). 7. A detail (2/100:02).
212. Fragments of textiles. 1. A polychrome woollen mat, rug-type, both ends with twined fringe (6/4:1). 2,4. White woven linen shroud (6/4:2,8:9). 3. White woven linen shroud, with broad blue or green woven stripes (6/6:23). 5. Outer shroud, thin polychrome, striped linen (6/9:3a). 6. Inner shroud, coarse white linen (6/9:3b).
213. 1. A wrap of coarse cotton (14/2:2). 2. A detail, the factory stamp on the damūr (14/2:2). 3. A loincloth and a pillow or a face covering, cotton (14/2:1,3).
214. 1–2. Fragments of linen shroud (10/4:2,6:1). 3. A detail of wool with brown and beige stripes and fringe with linen stripe knotted (17/1:1). 4. Leather fragments of a small goat or sheep (44/3:3).
215. Rock drawings. 1. Site 7. 2. Site 35. 3. Site 37.
216. Rock drawings. 1. Site 46. 2. Site 47. 3. Site 49.
217. Rock drawings. 1. Site 50. 2. Site 51.
218. 1. The valley of the rock drawings. 2. Site 35. 3. Site 7. 4. Site 46. 5. Site 37.
219. 1. Site 47. 2. Site 49. 3. Site 51. 4. Site 50.

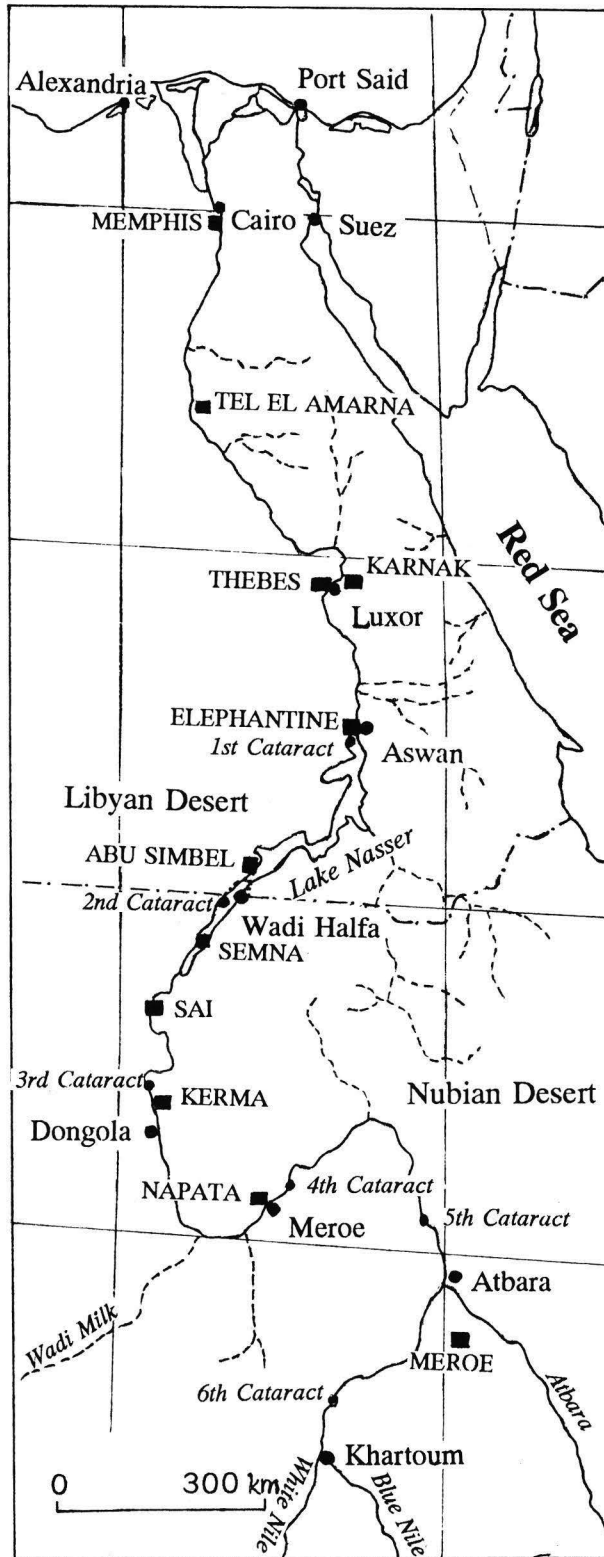

1. Map of the Egypt and Nubia.

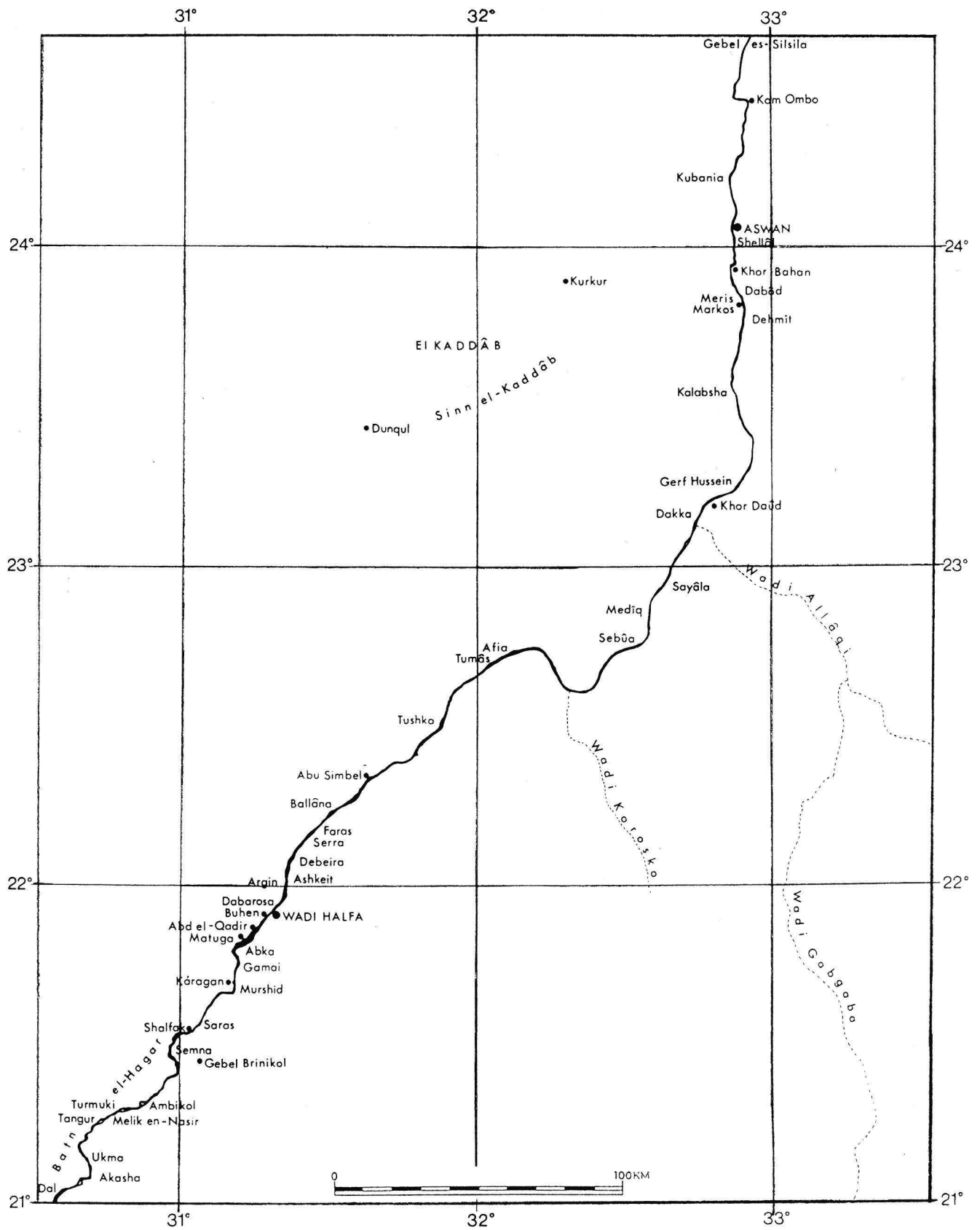

2. Map of Lower Nubia.

THE FINNISH NUBIA EXPEDITION
1964 - 65

SITE MAP

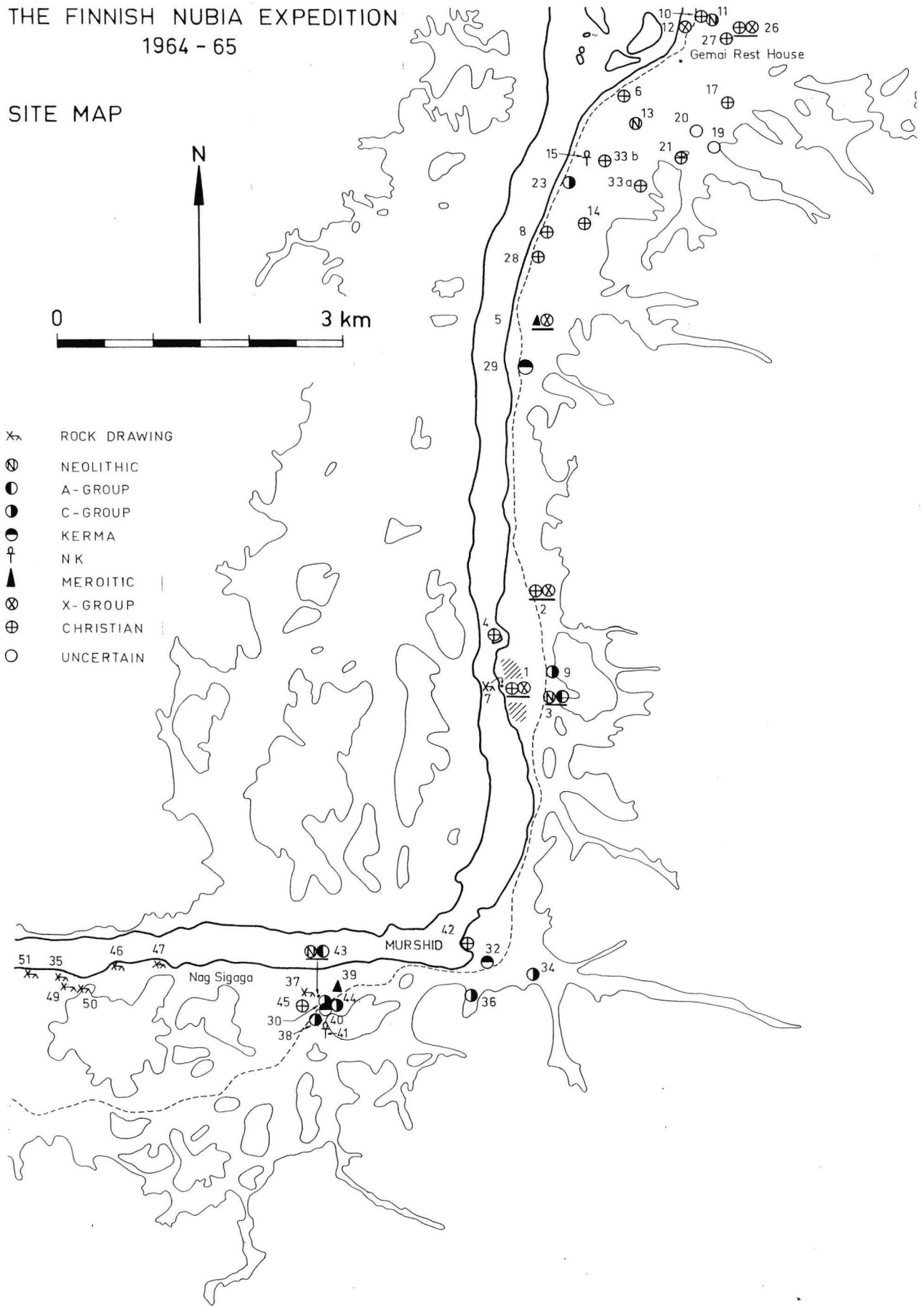

3. Map of the FNE Concession Area with the Sites.

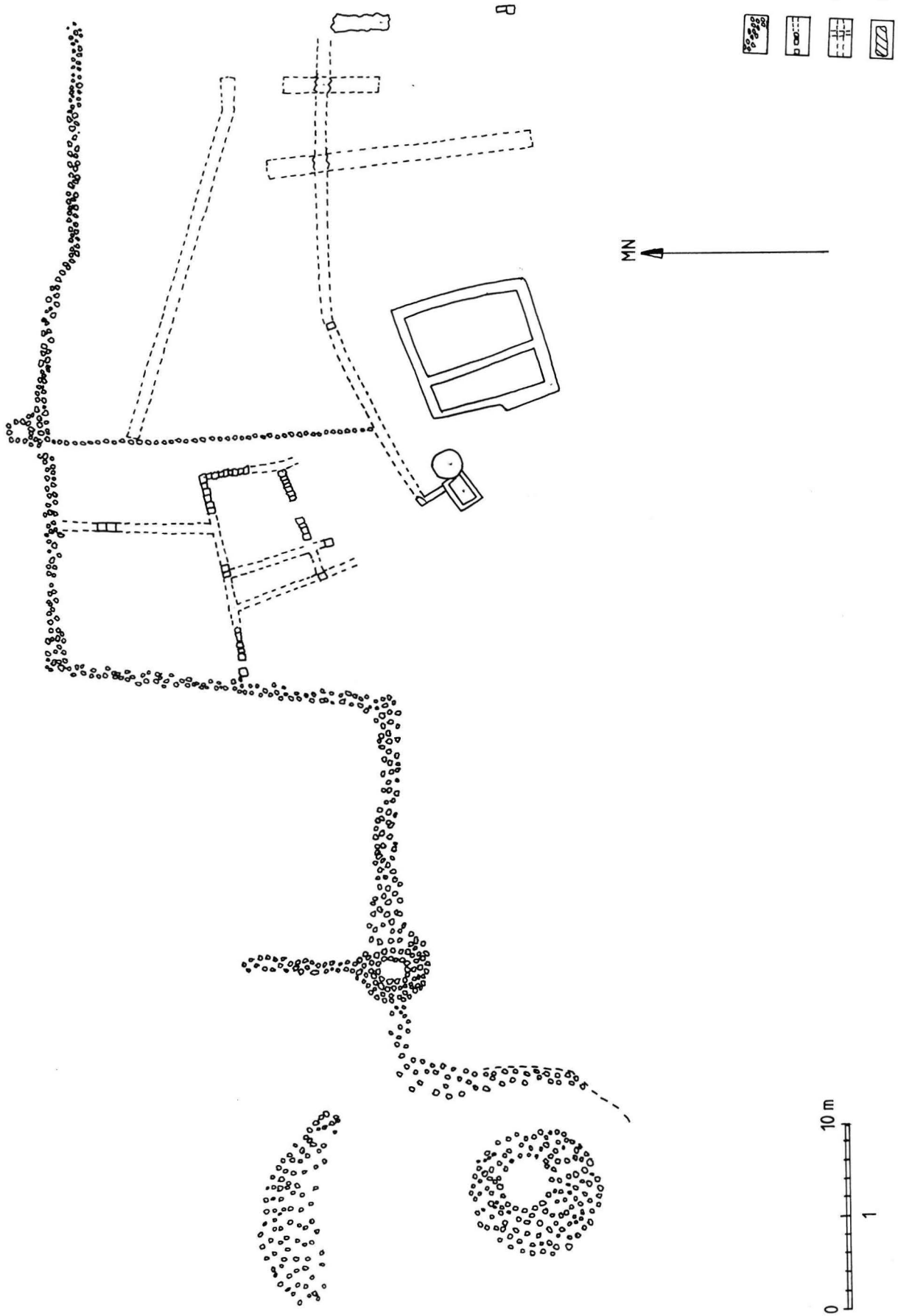

4. Site 1. Plan.

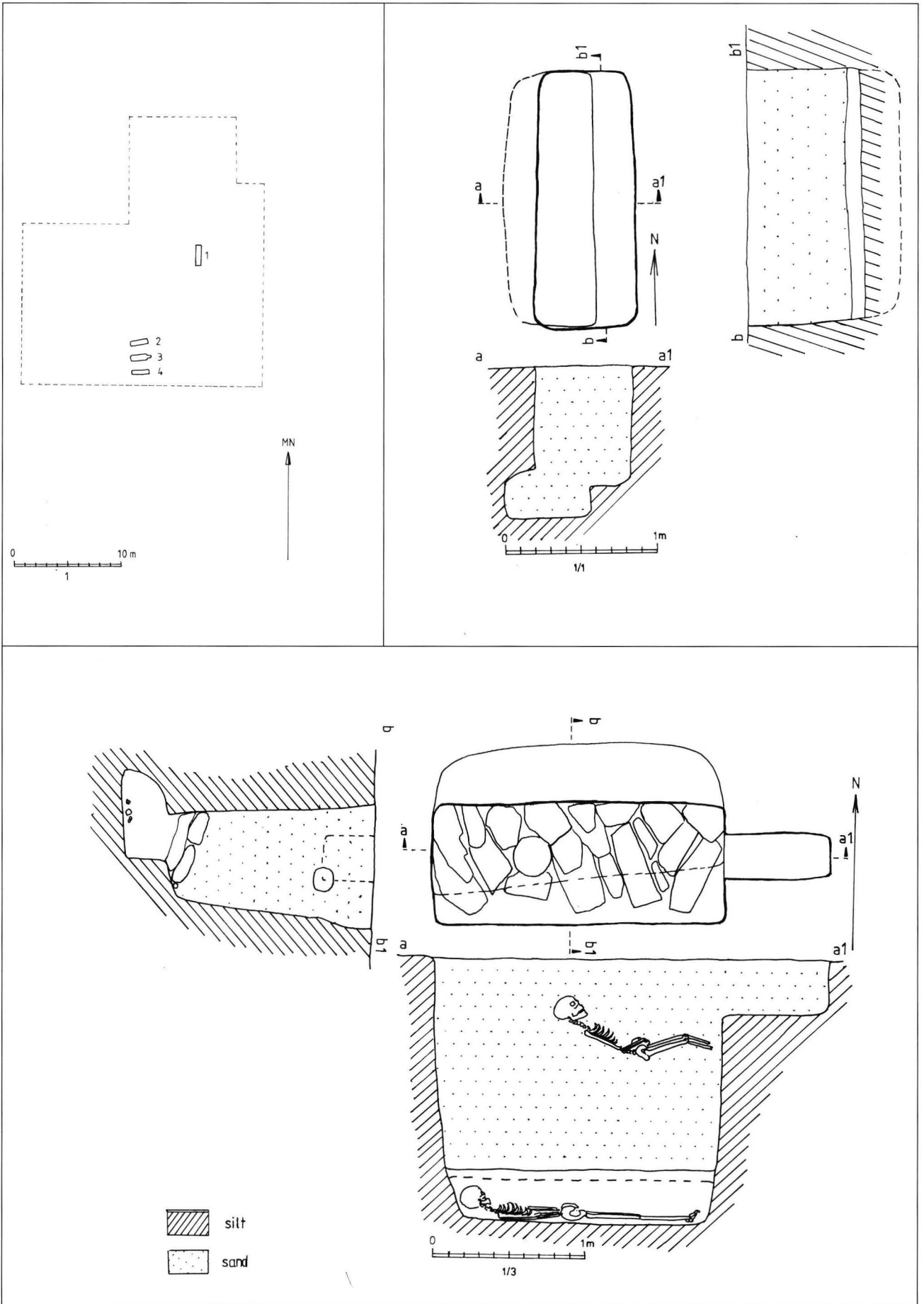

5. Site 1/1-4. Plan. 1/1,3.

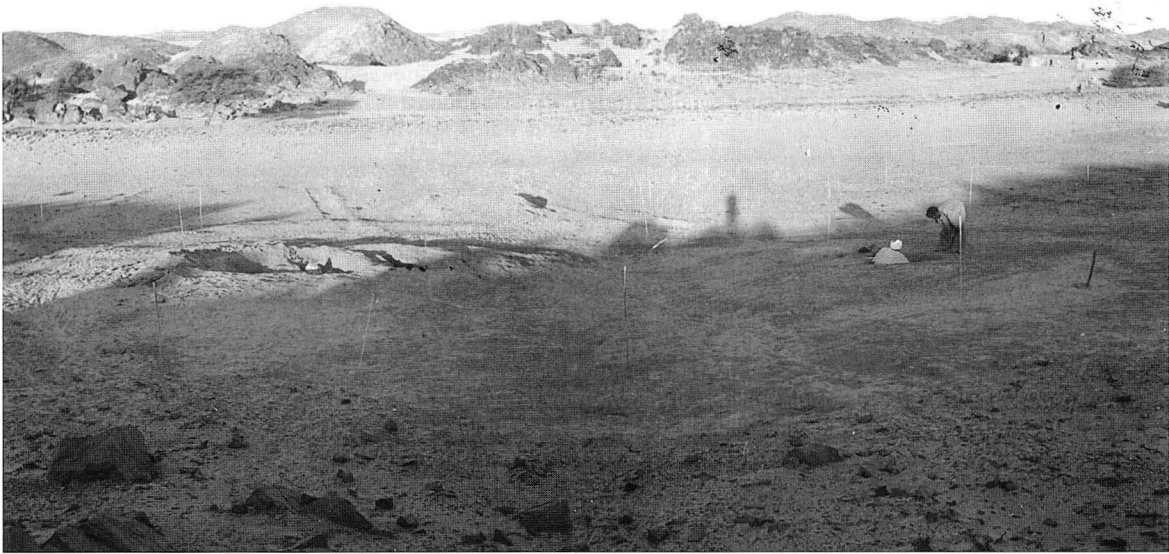

1.

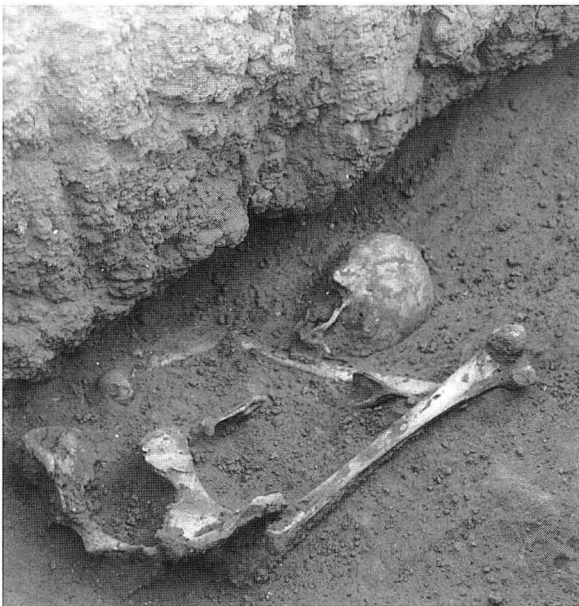

2.



3.

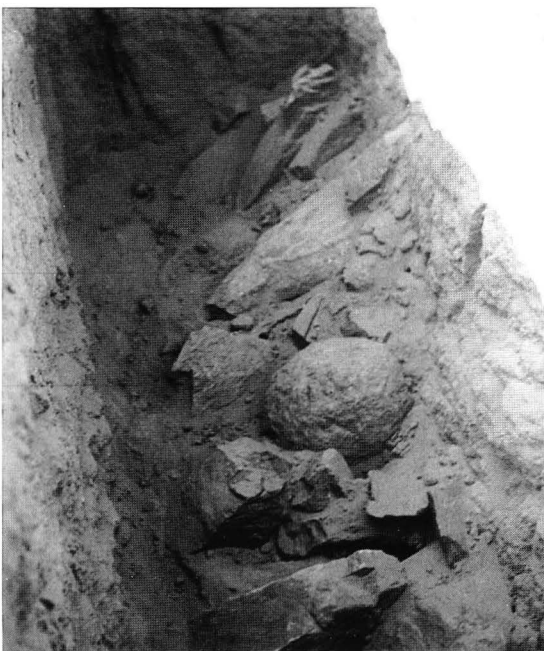

4.



5.

6. 1. View over the site 1, in the foreground graves 1-4, from SE.
2. Bone heap in 1/1. 3-5. Sealing and a body in the shaft (1/3).

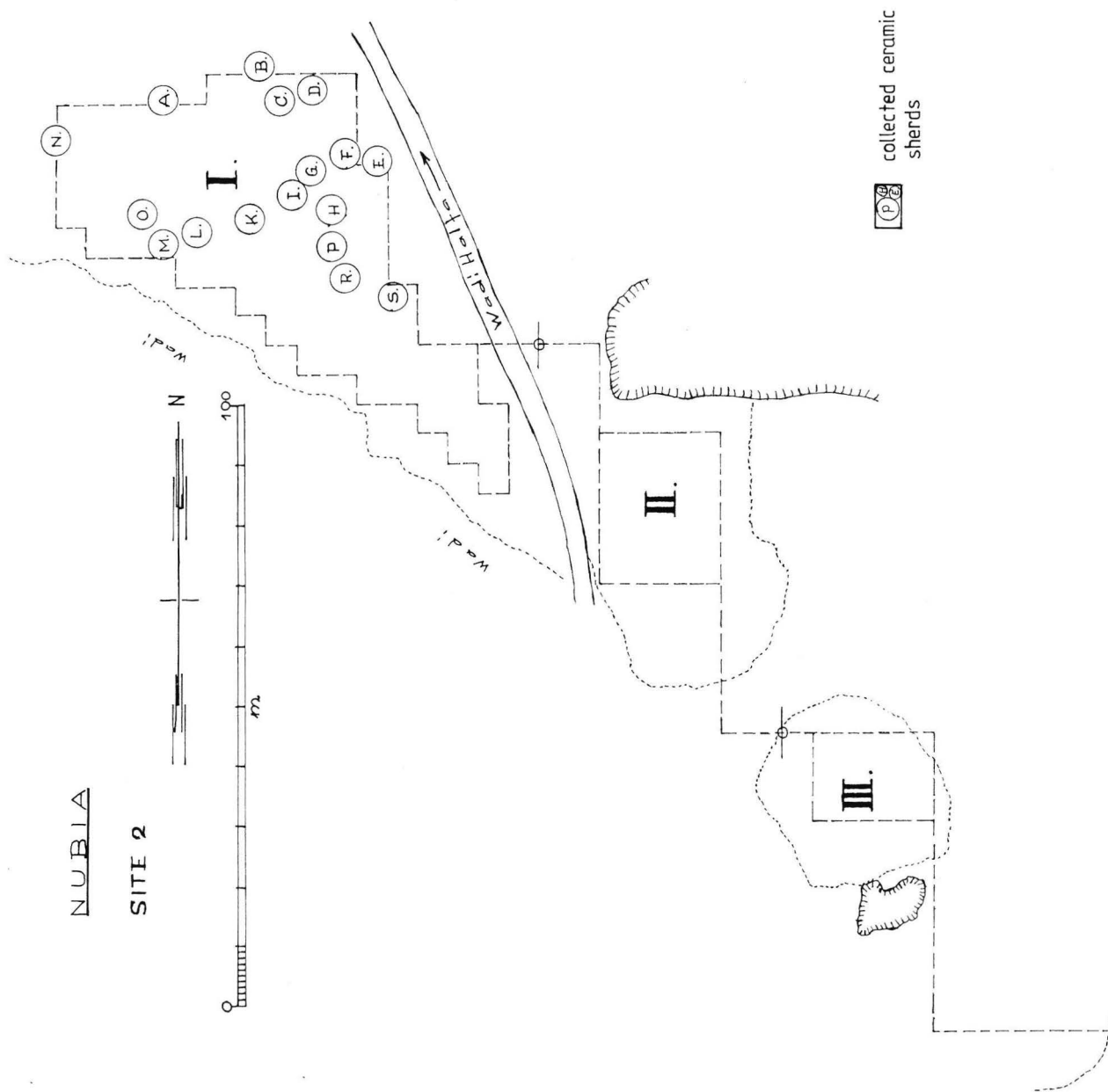

7. Site 2. Plan, excavated areas I, II, III.

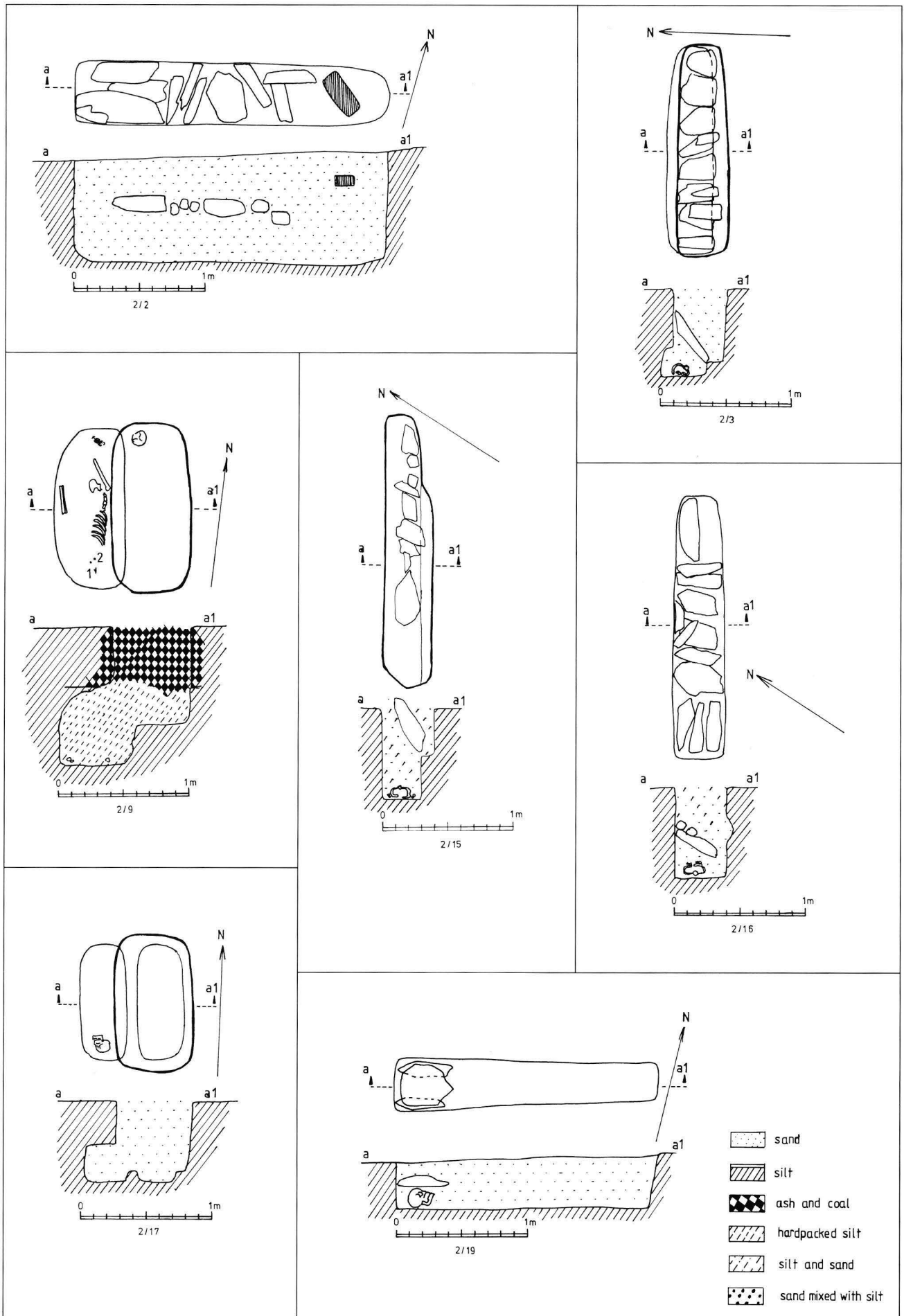

8. Site 2/2,3,9,15-17,19.

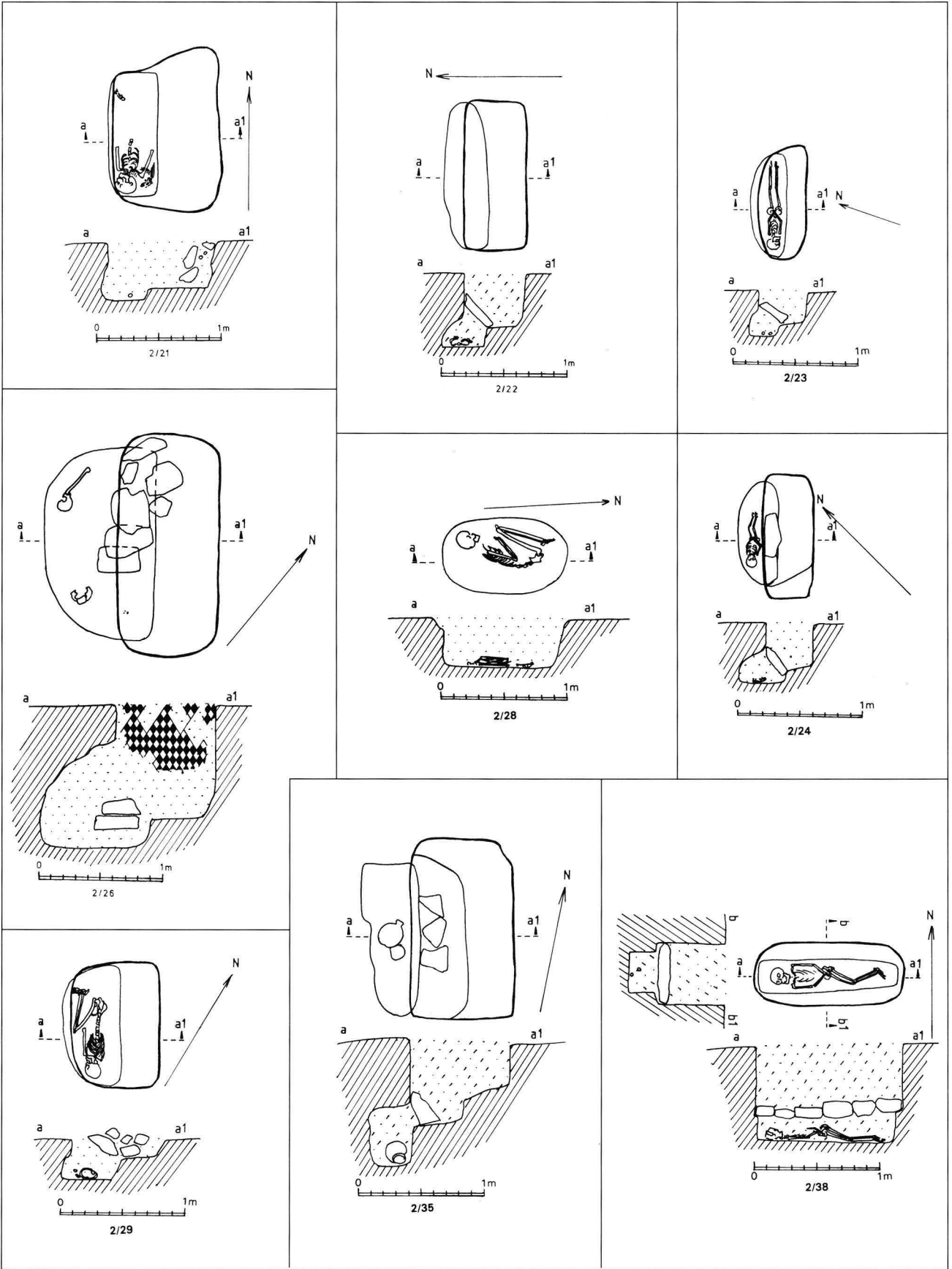

9. Site 2/21-24,26,28,29,35,38.

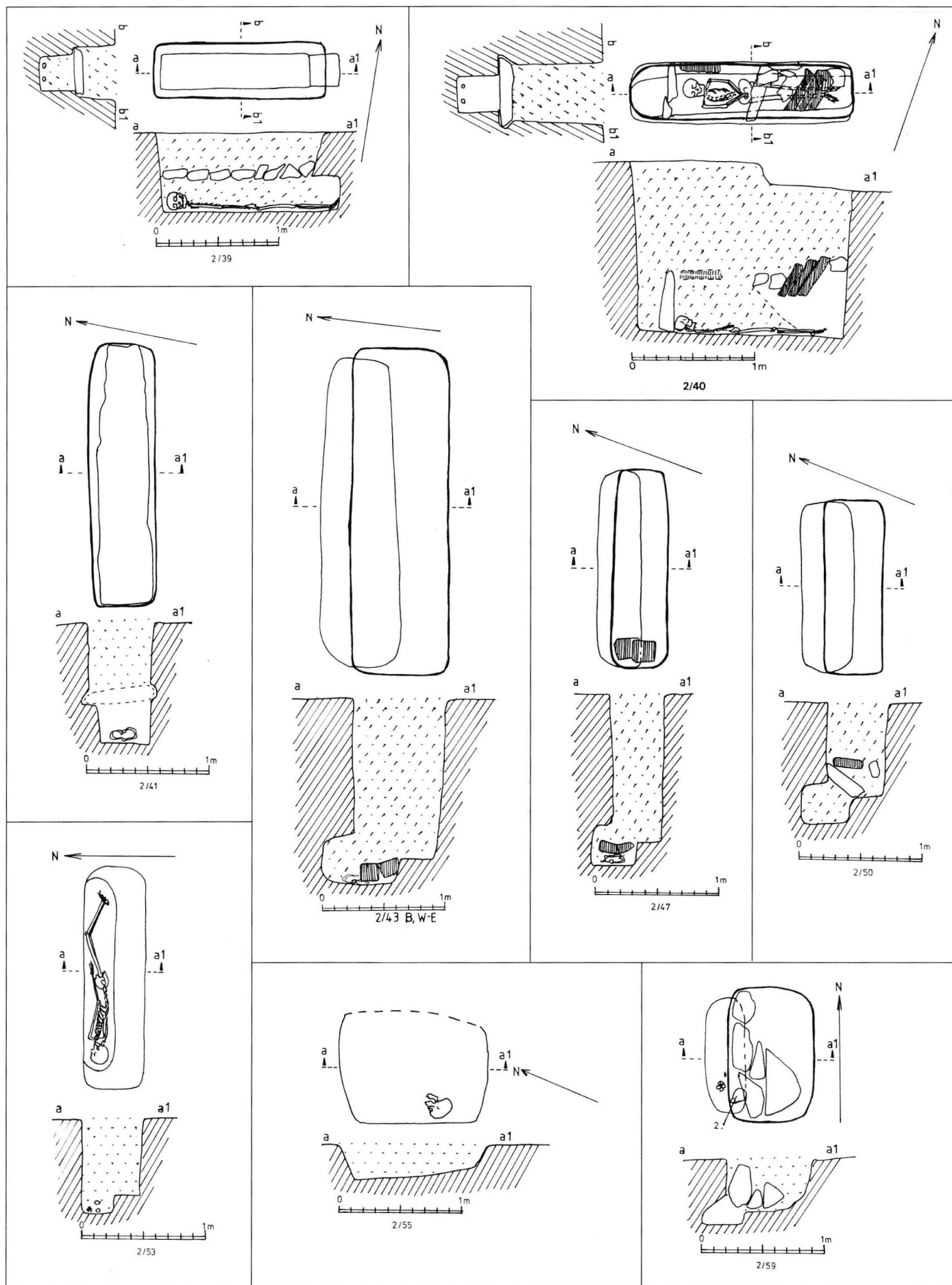

10. Site 2/39-41,43,47,50,53,55,59.

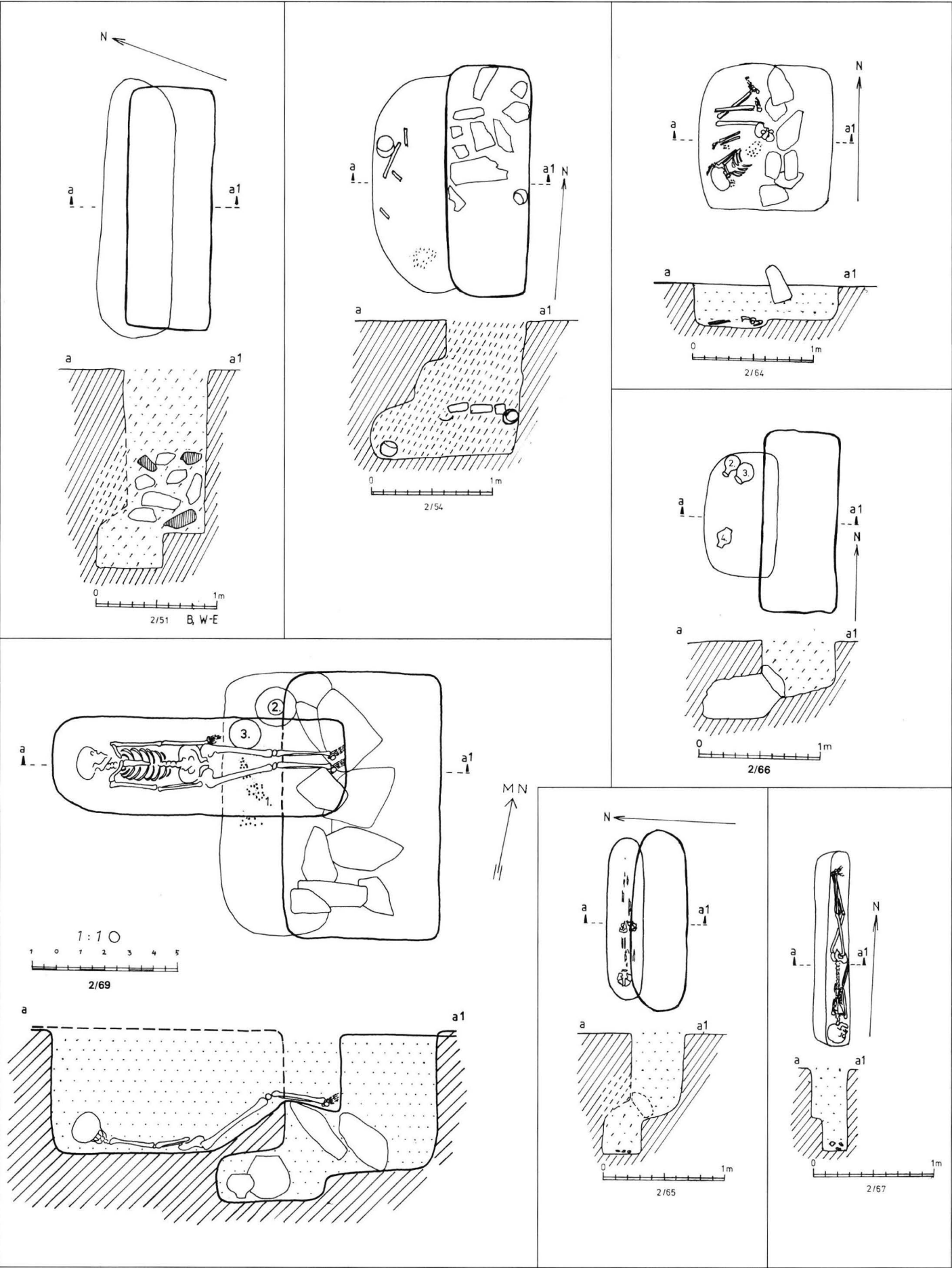

11. Site 2/51,54,64-6,7,69.

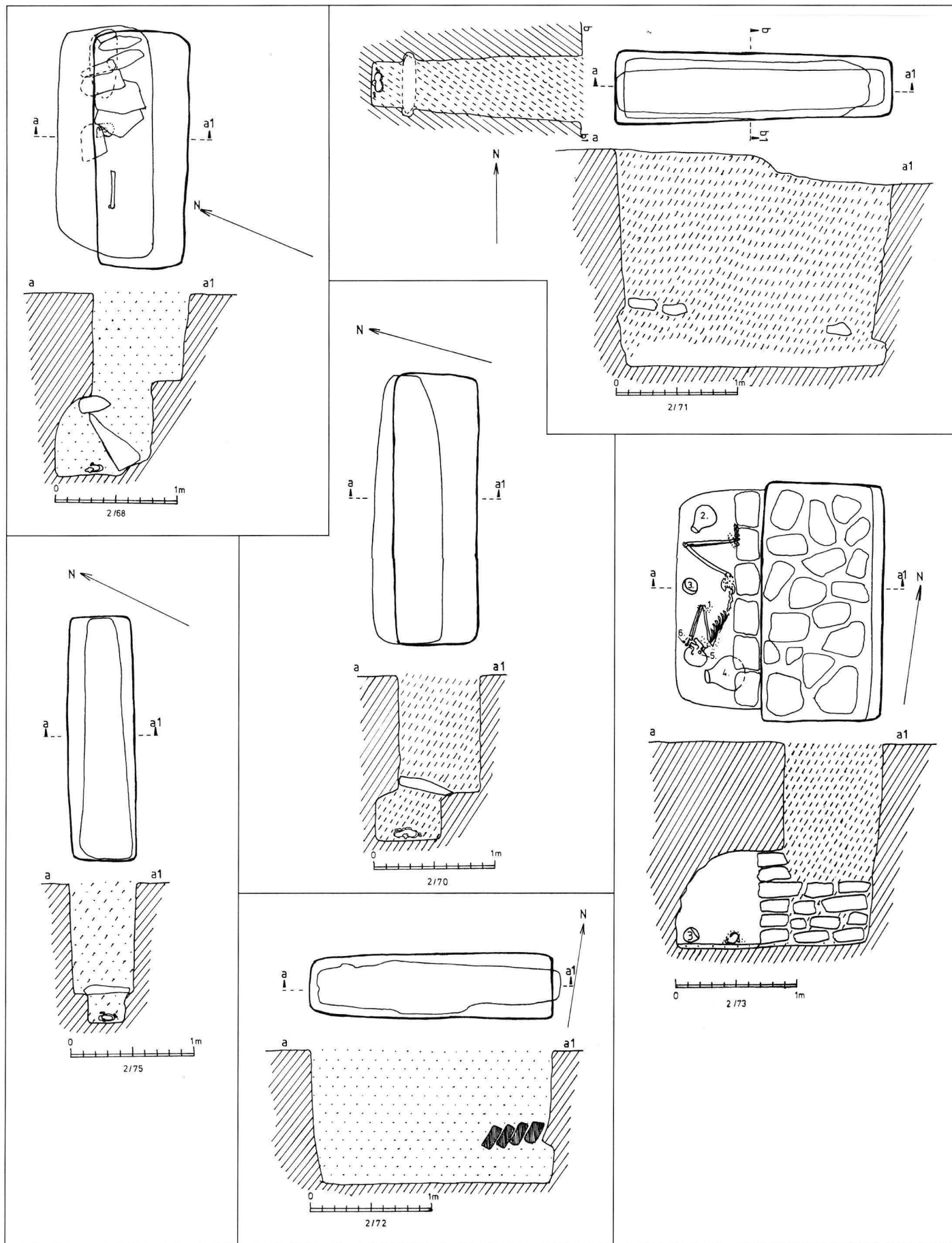

12. Site 2/68,70-73,75.

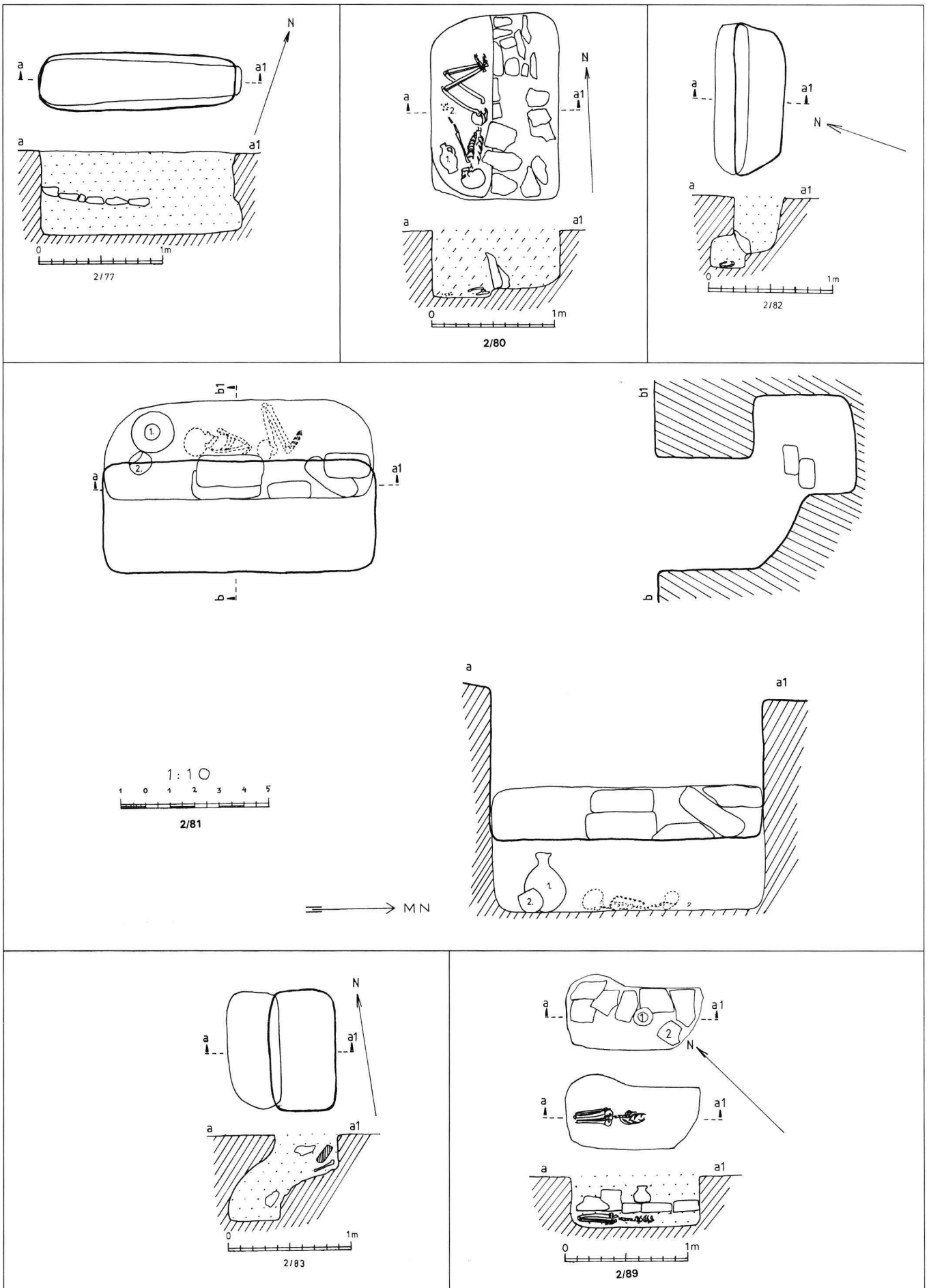

13. Site 2/77,80-83,89.

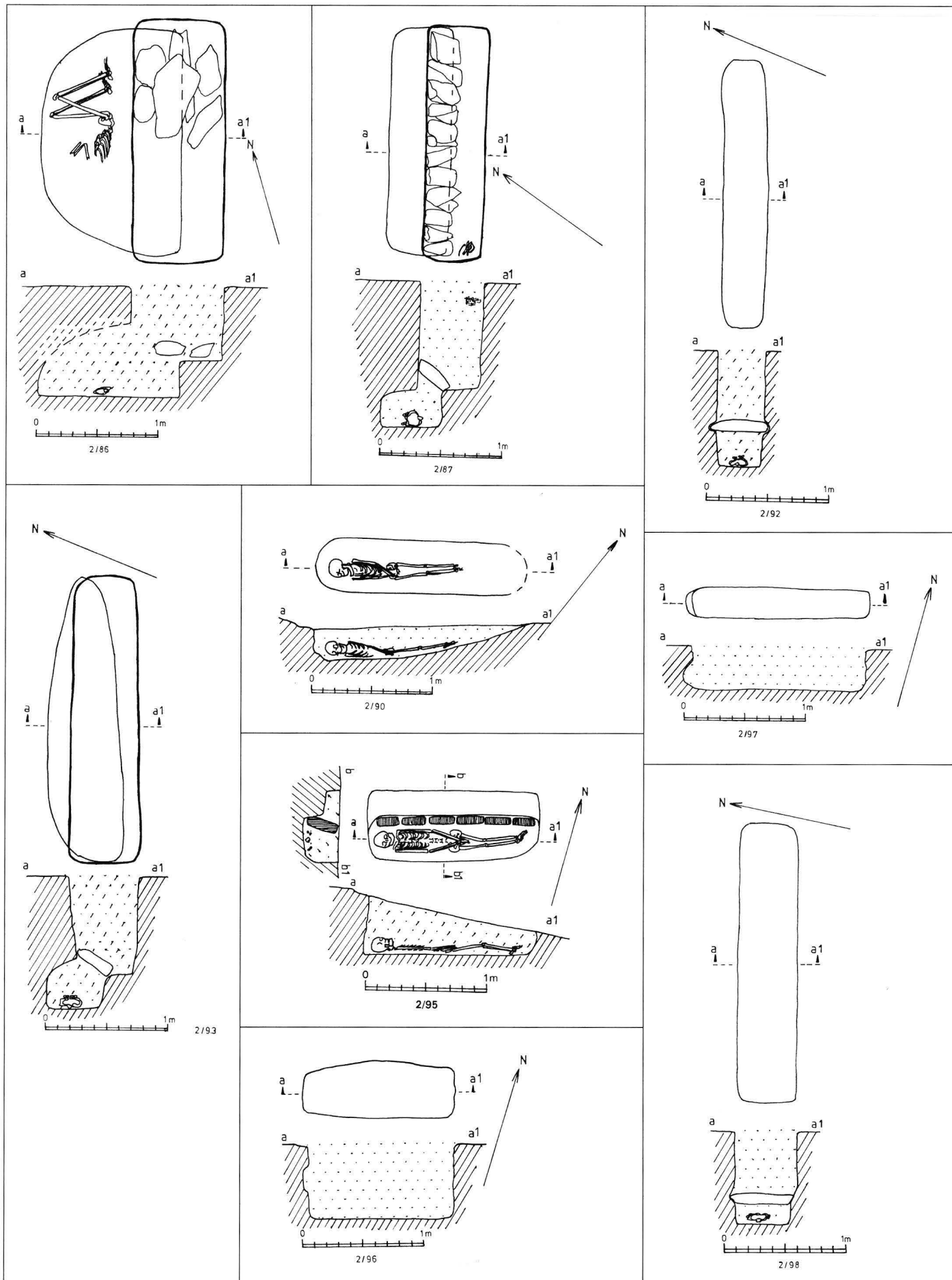

14. Site 2/86,87,90,92,93,95-98.

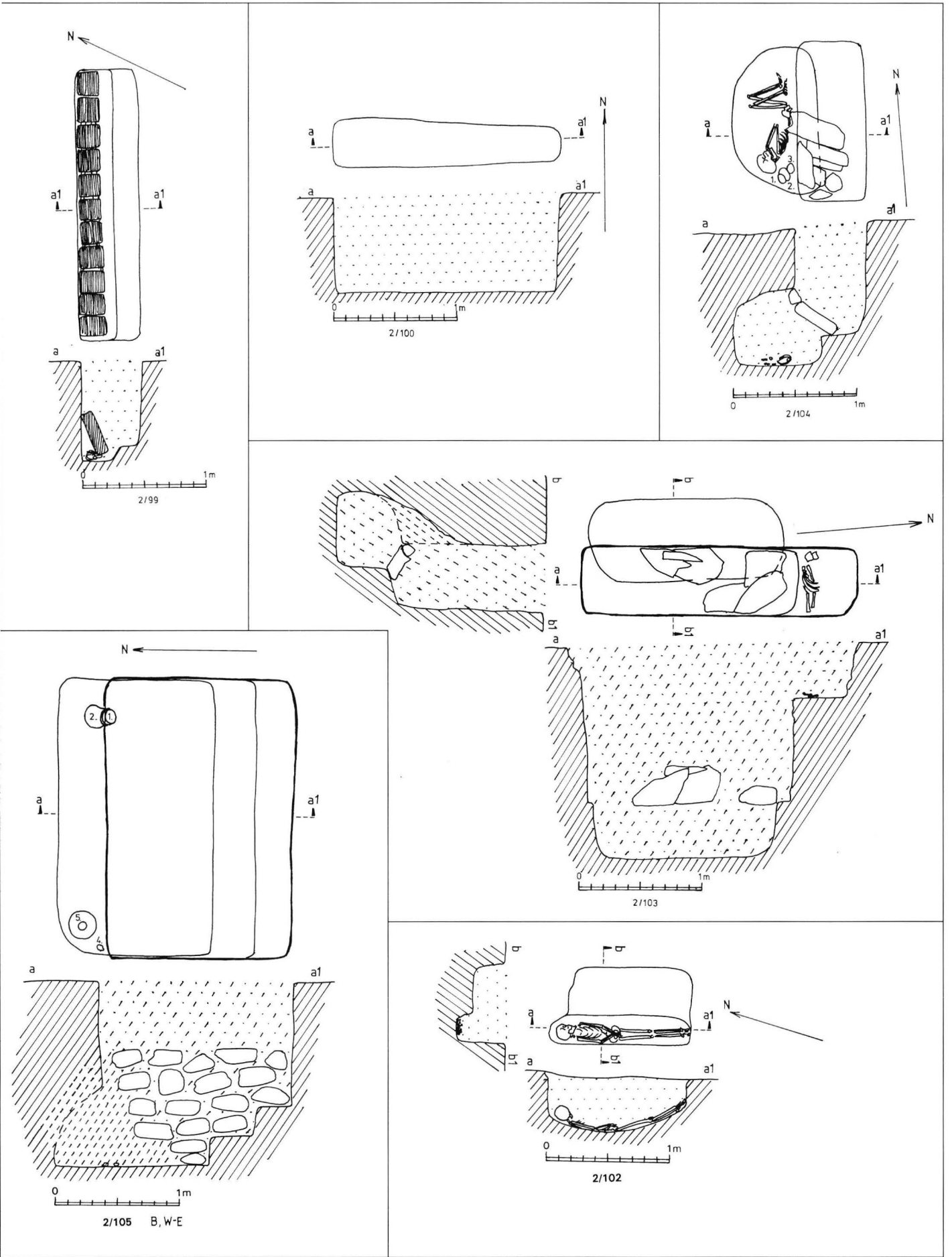

15. Site 2/99-100,102-105.

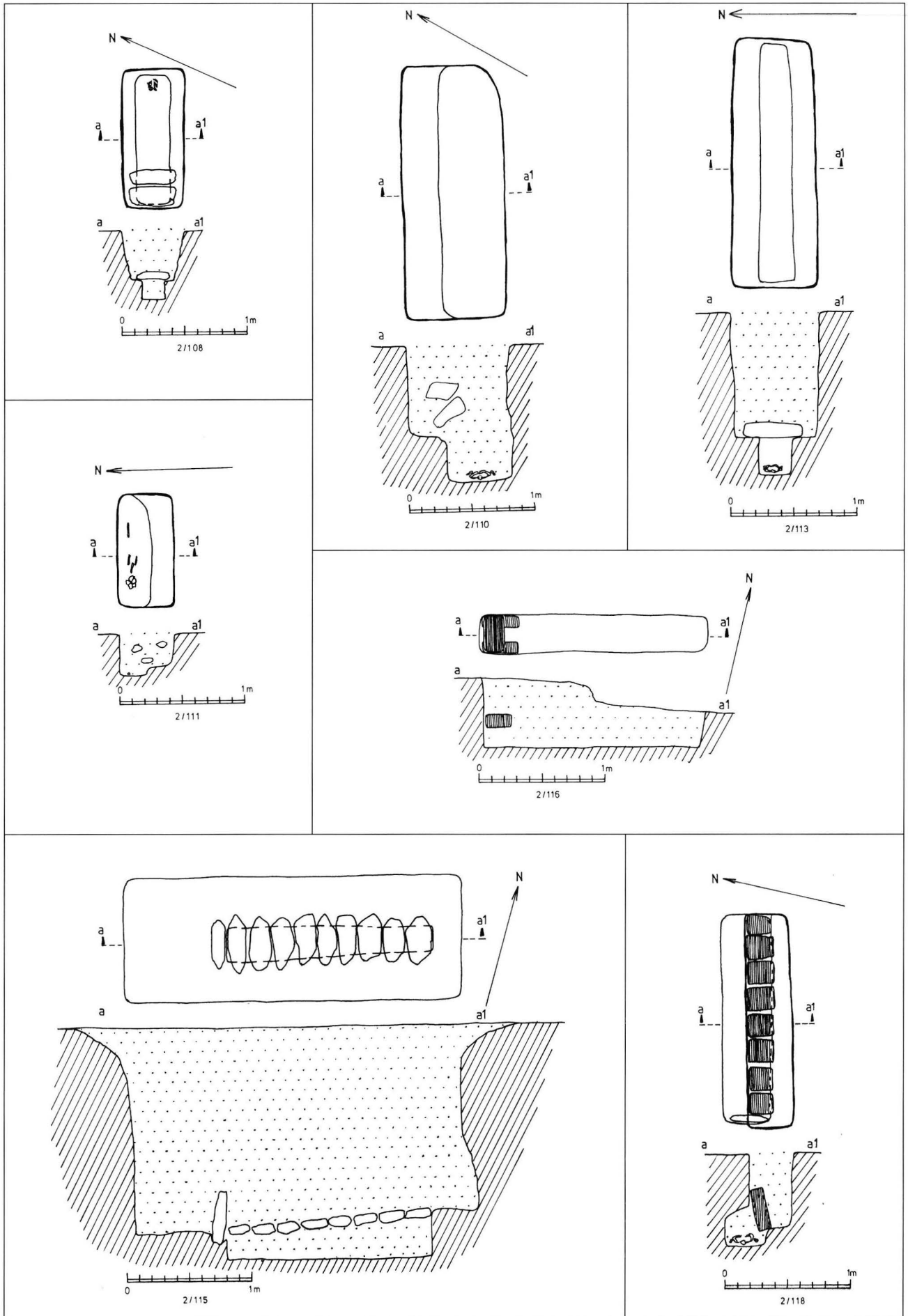

16. Site 2/108,110,111,113,115,116,118.

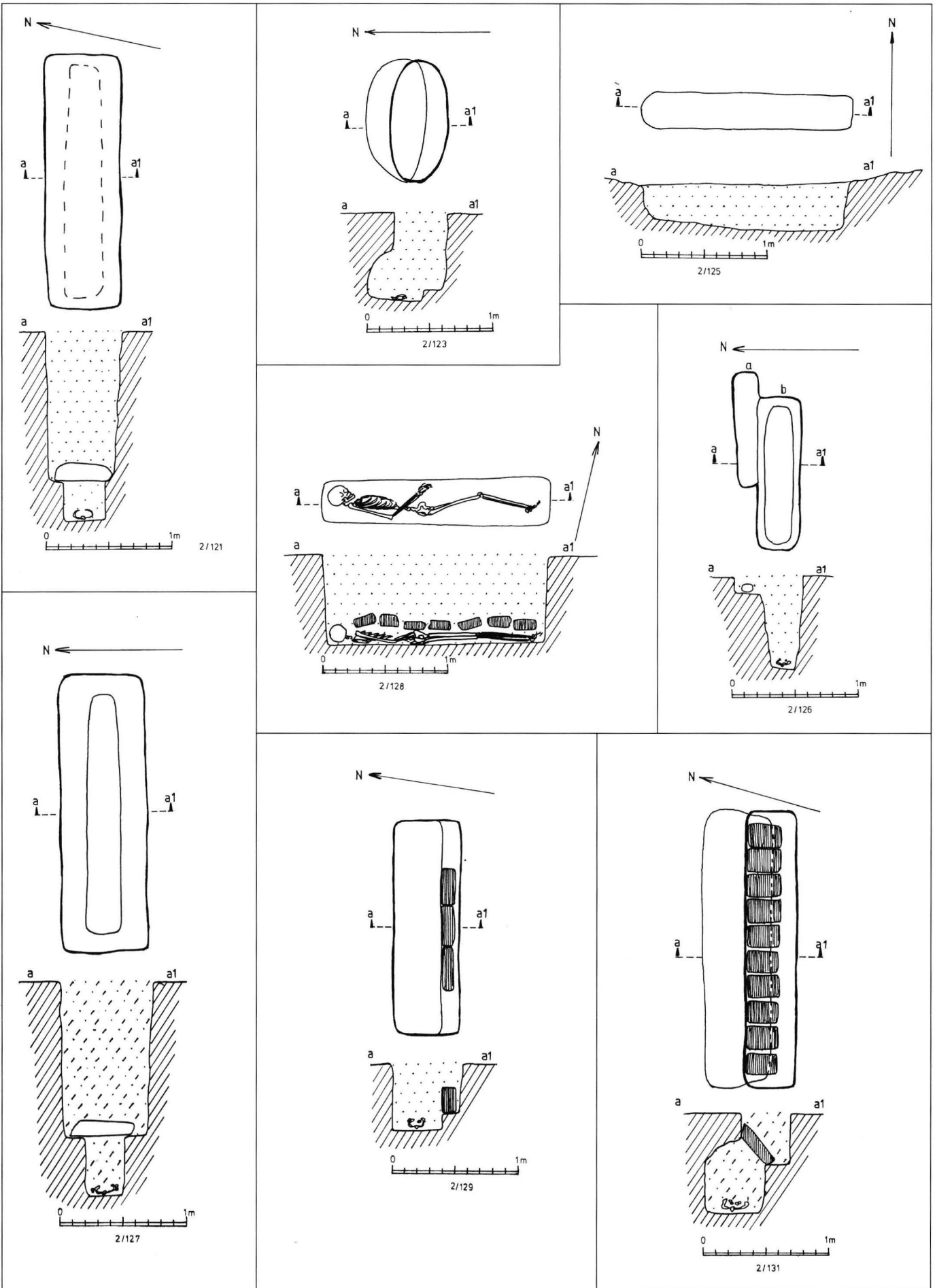

17. Site 2/121,123,125-129,131.

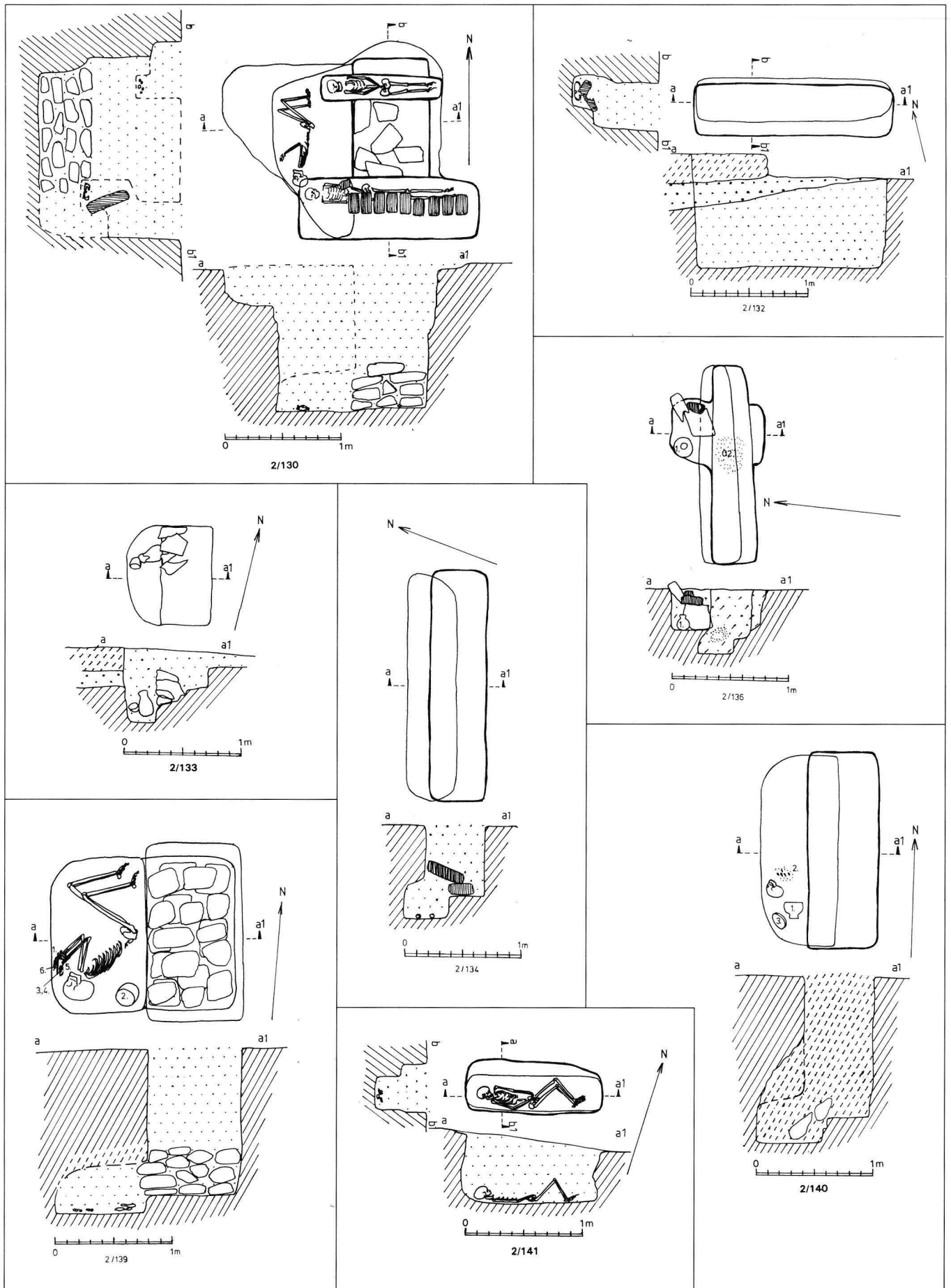

18. Site 2/130,132-134,136,139-141.

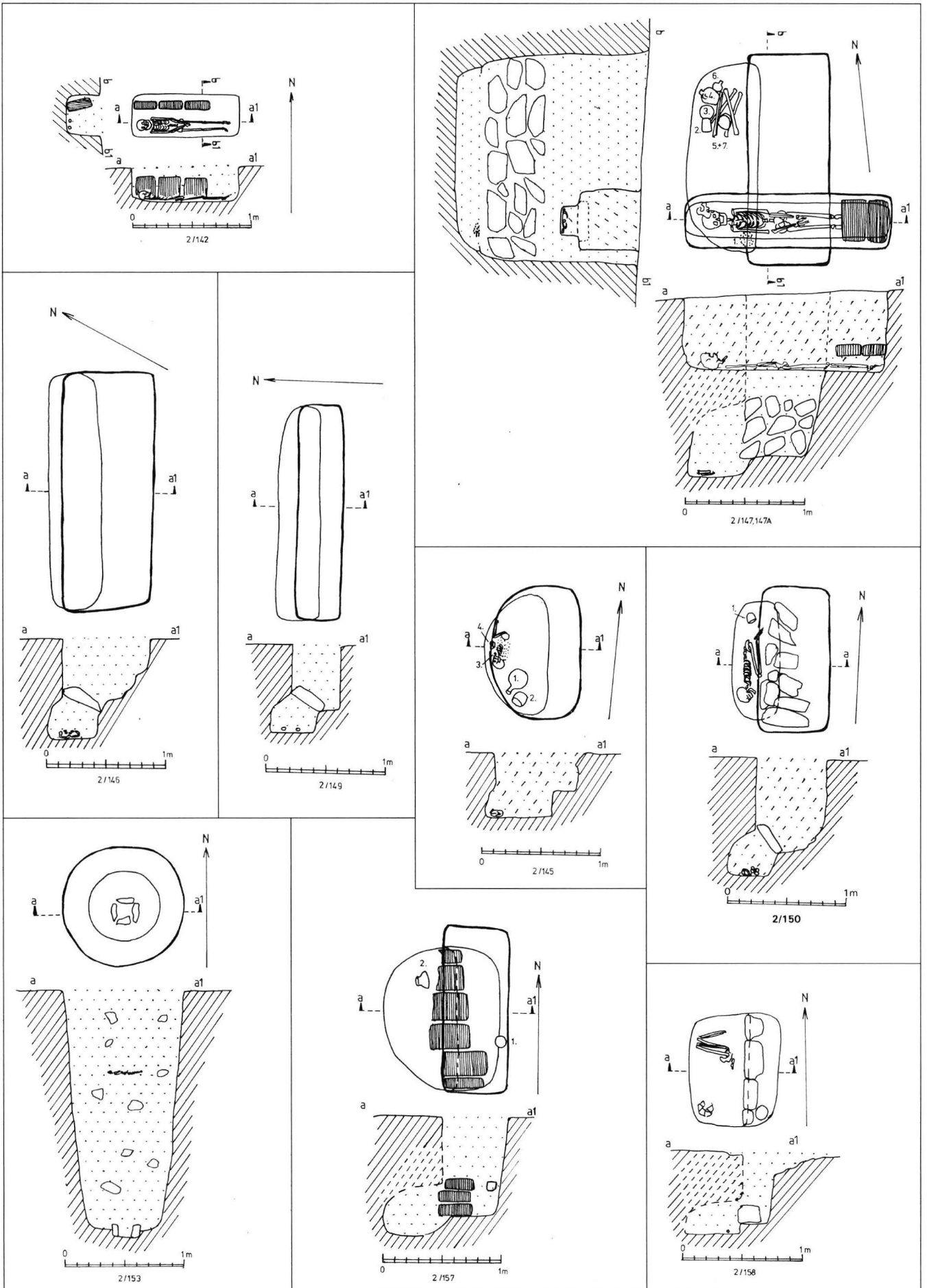

19. Site 2/142,145-147,147A,149,150,153,157,158.

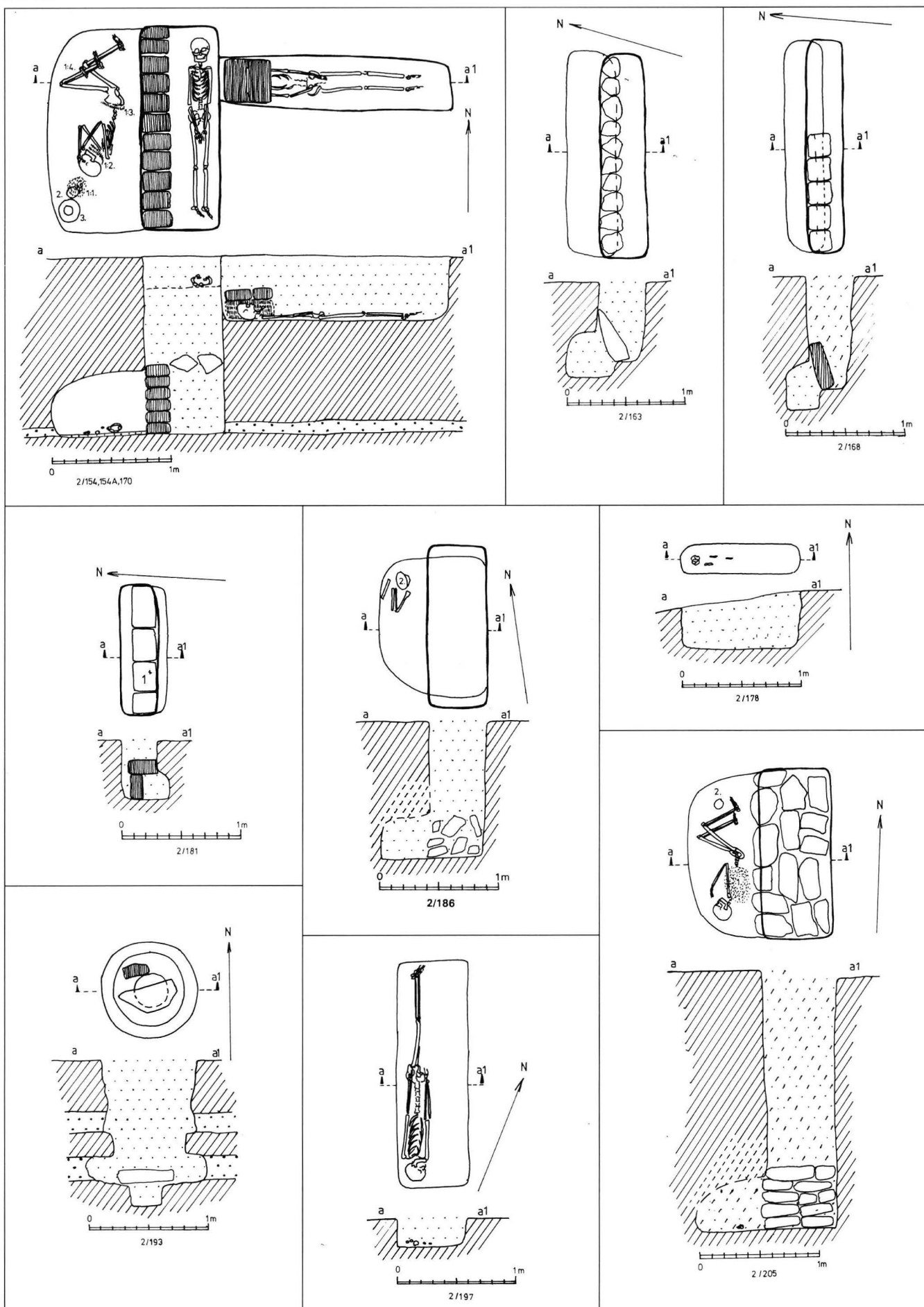

20. Site 2/154,154A,170,163,168,178,181,186,193,197,205.

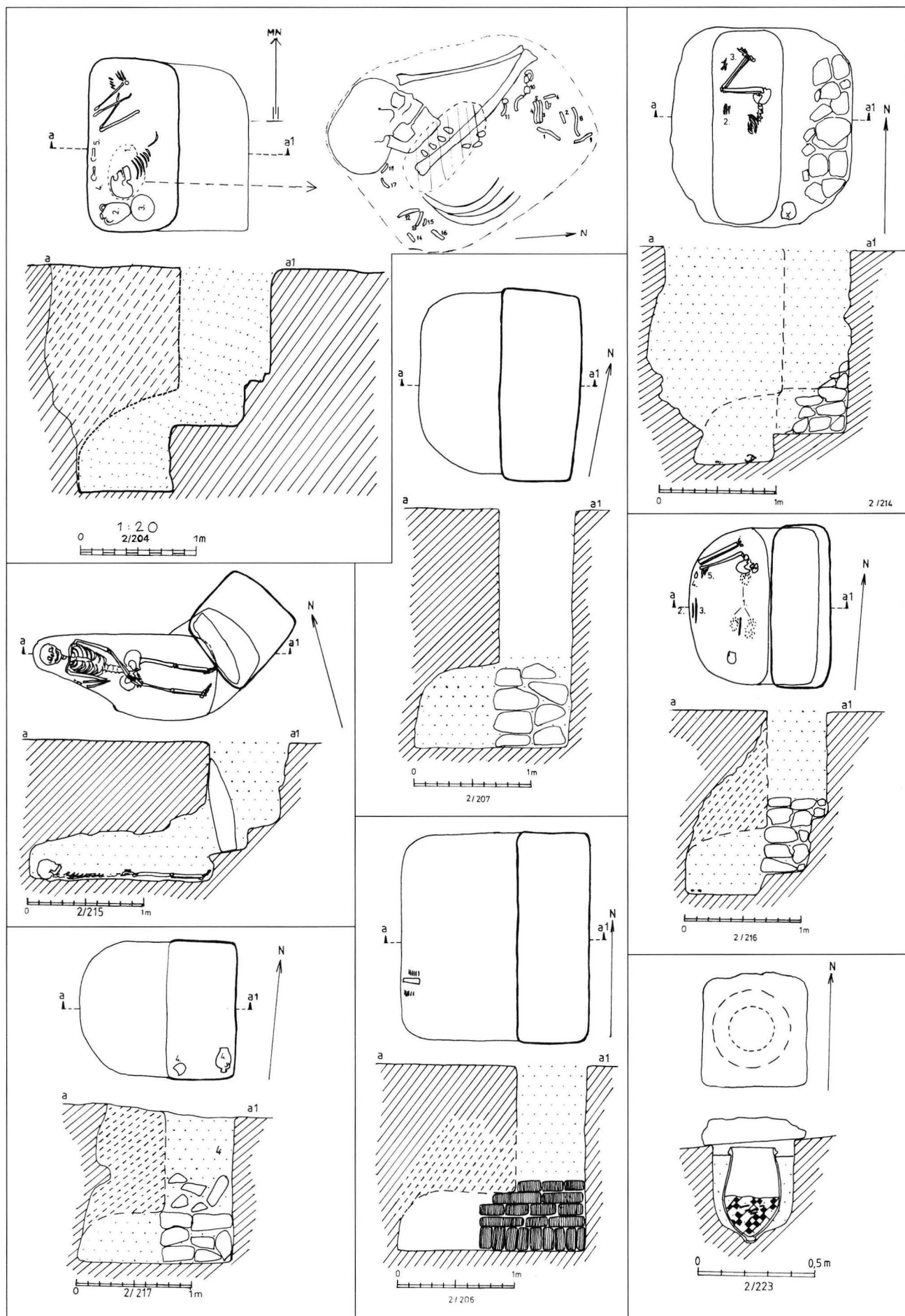

21. Site 2/204,206,207,214-217,223.



1.



2.



3.



4.

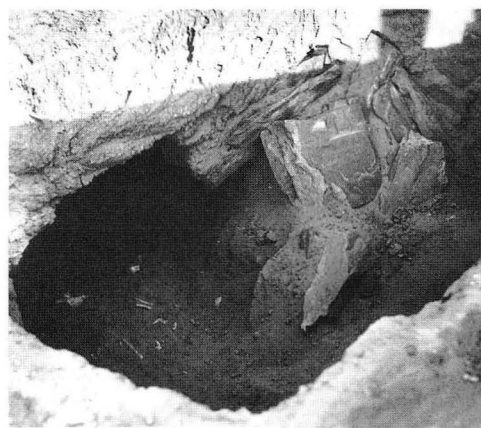

5.

22. Site 2. 1. Aerial view. 2. View over parts I and II from S-SE. 3. View over parts II and III from N. 4. Sealing (2/95). 5. Sealing and a niche (2/49).

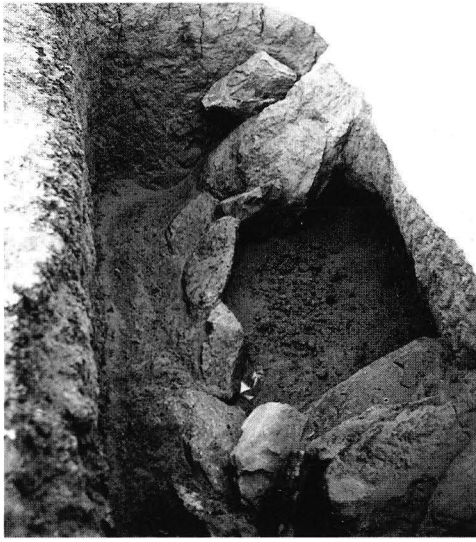

1.



2.



3.



4.



5.

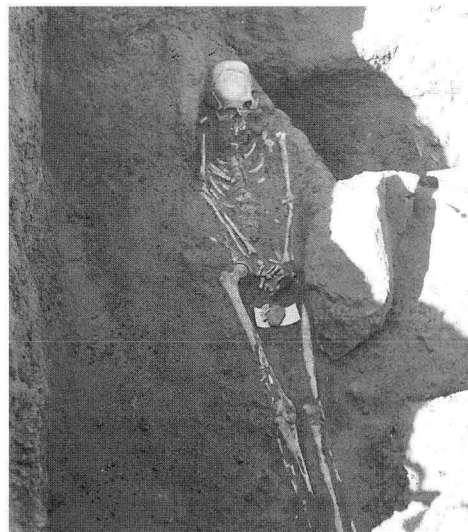

6.

23. 1-2. Sealings (2/107,193). 3-4. Sealing and a body of X-group in the shaft (2/130-3). 5. Child body in the NE-corner (2/130-1). 6. A body of Christian in the shaft (2/130-2).



1.



2.

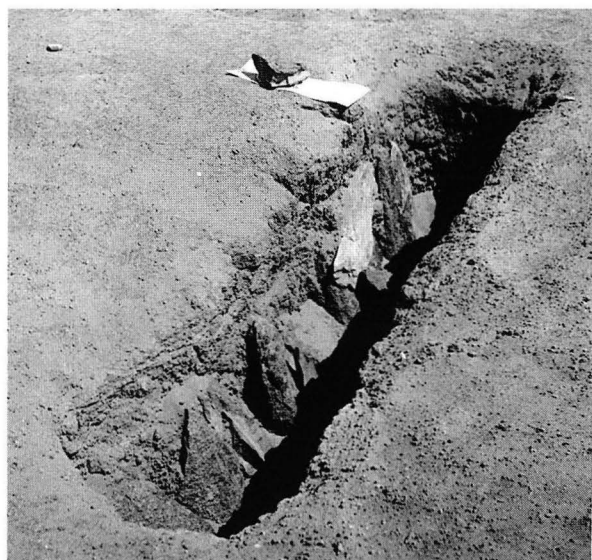

3.

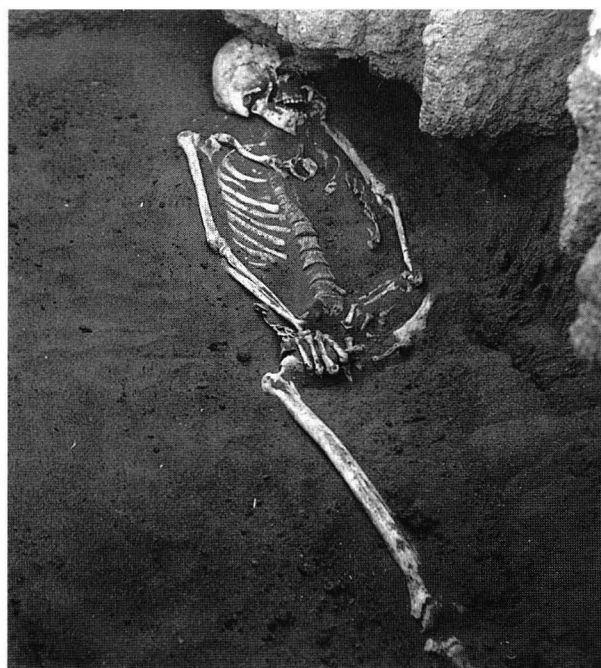

4.

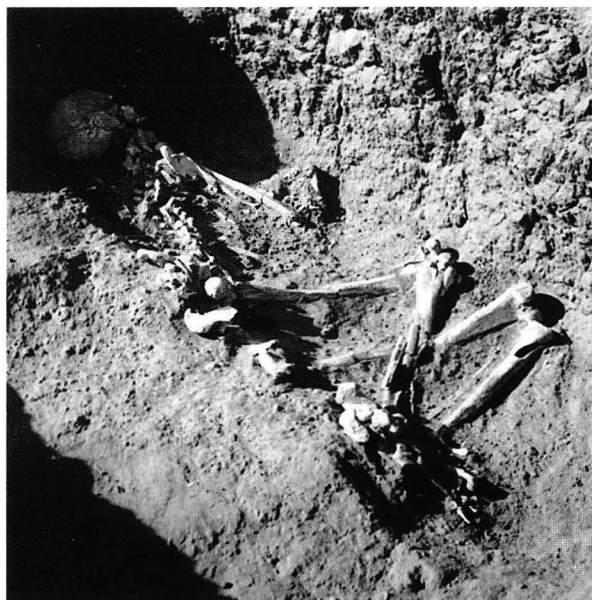

5.



6.

24. 1-2. 2/154A:3 pottery in situ and a body in the shaft. 3-6. Sealing and a body in the shaft (2/163). 5-6. Body in the shaft (2/80,104).



1.



2.

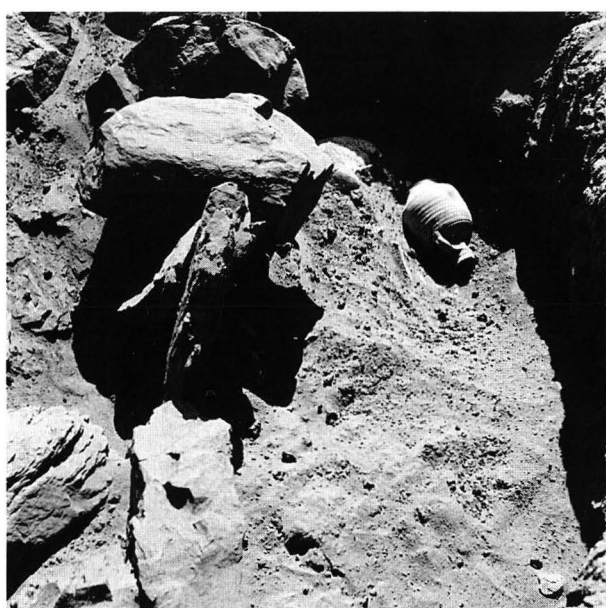

3.



4.

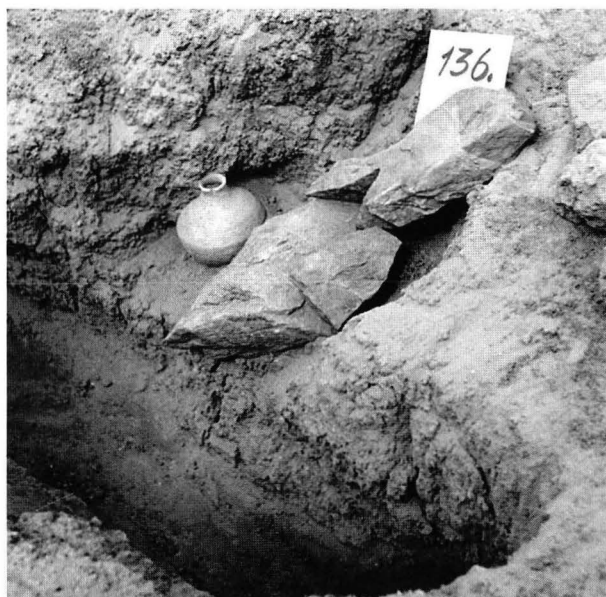

5.



6.

25. 1-2. Body in the shaft (2/139,147A). 3-6. Pottery in situ (2/80:1,83:1,3;136:1;69:2,3).

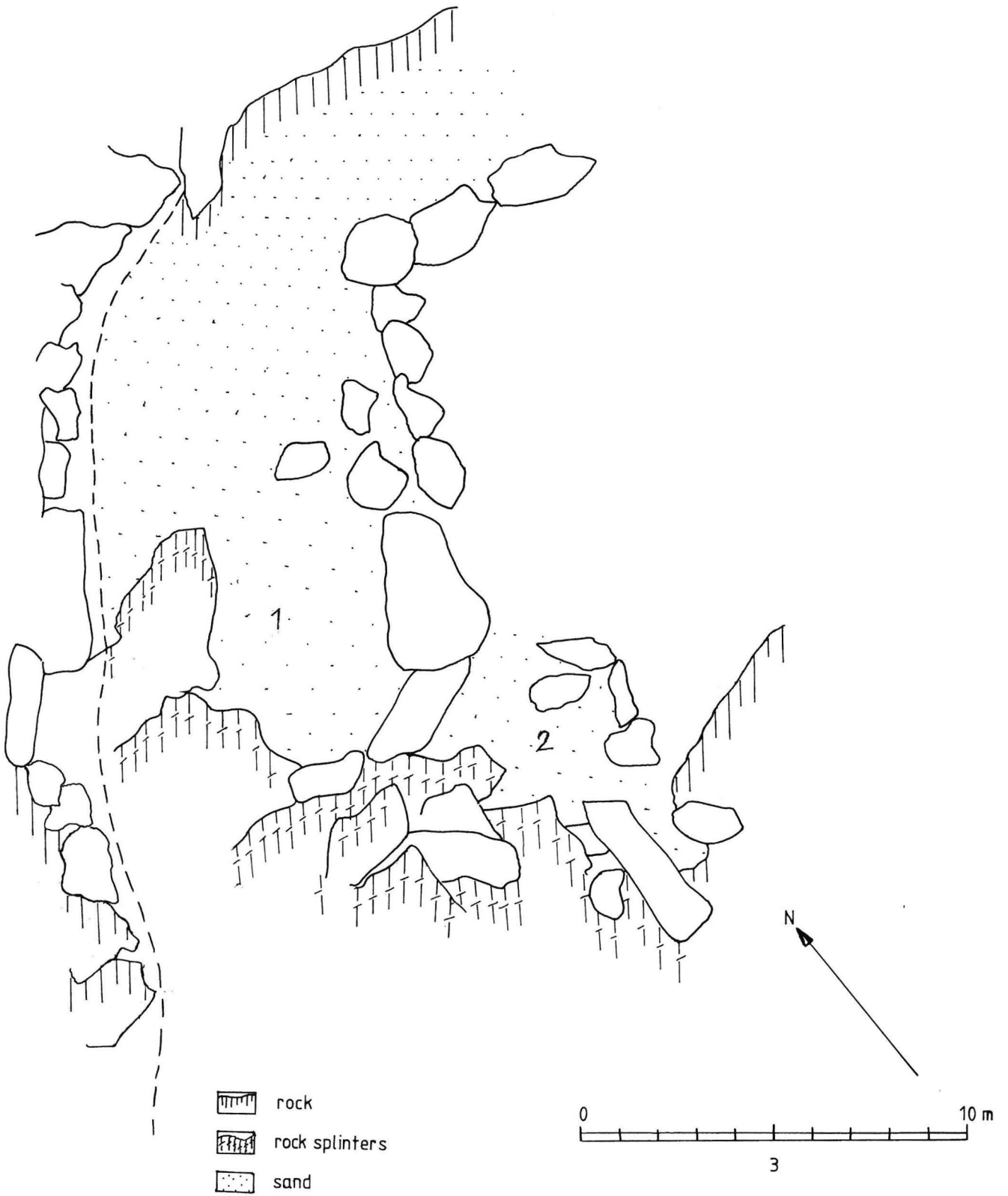

26. Site 3. Plan.

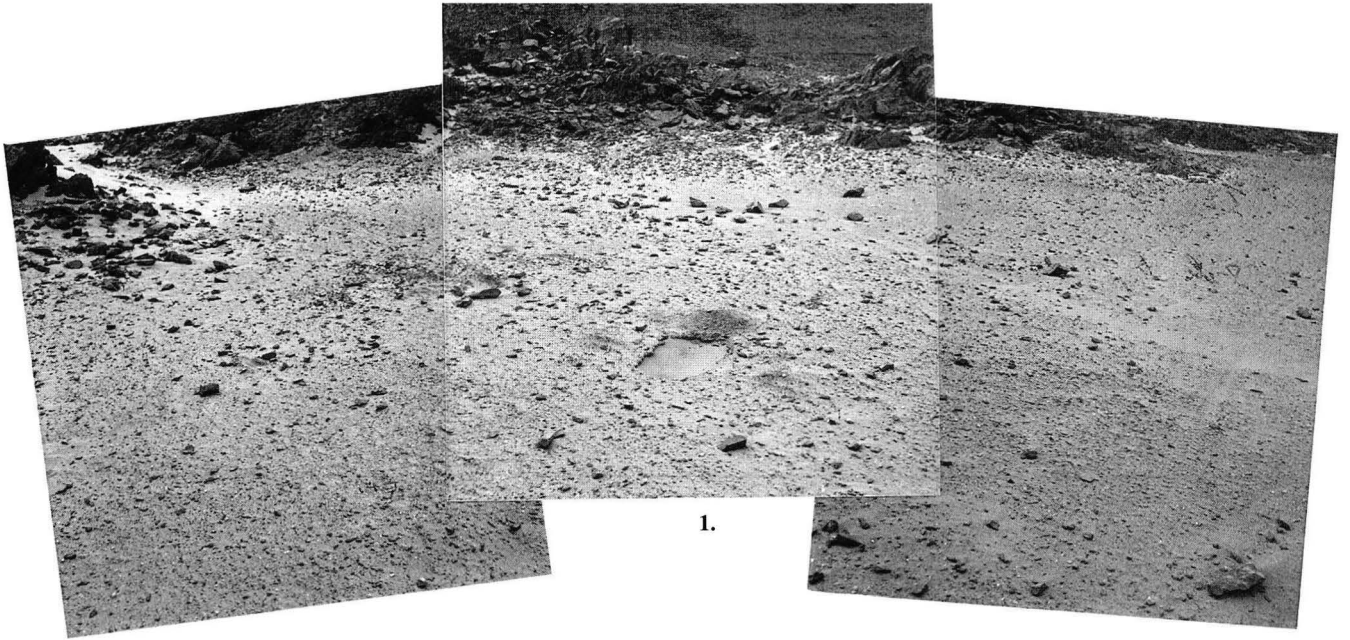

1.

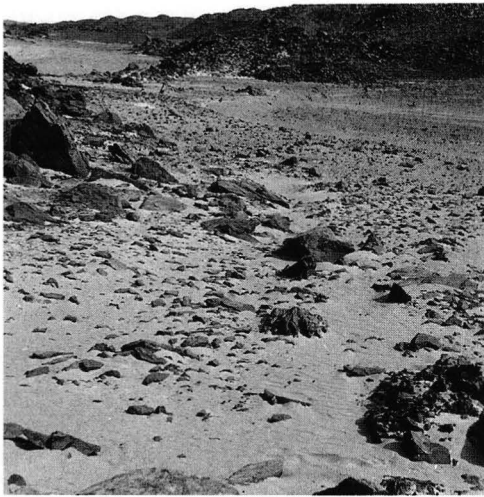

2.

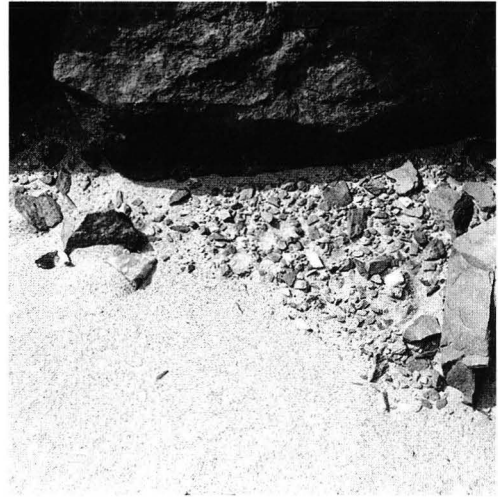

3.

27. Site 3. 1. View over the site, from S. 2. Before excavation, from W. 3. Detail, from E.

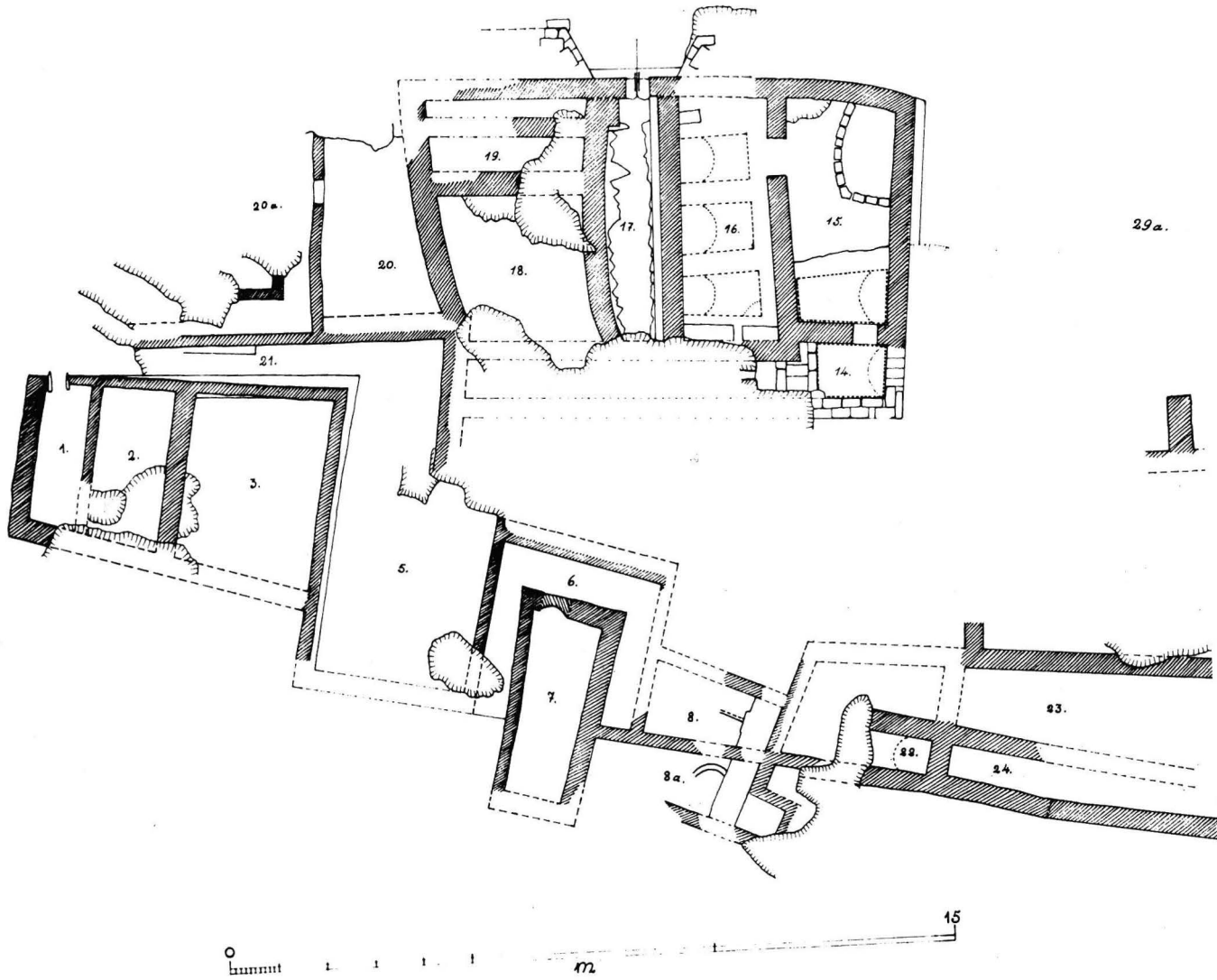

NUBIA SITE 4 1965.

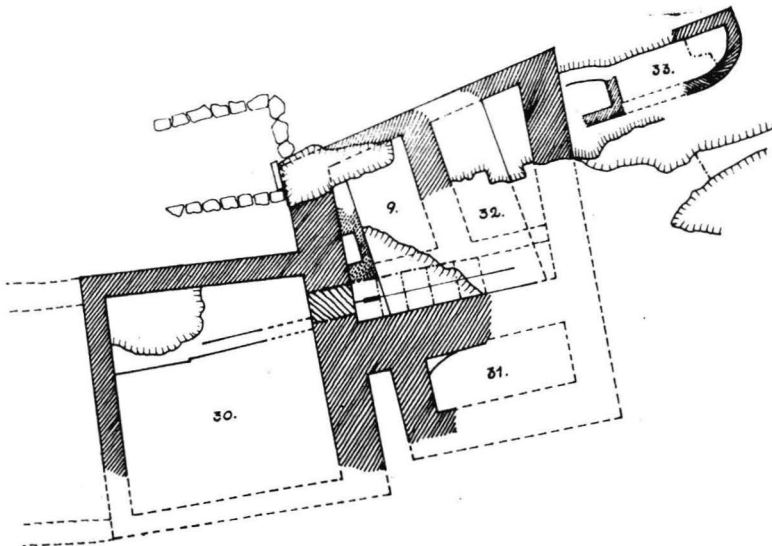
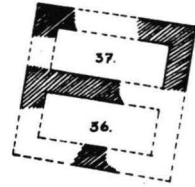
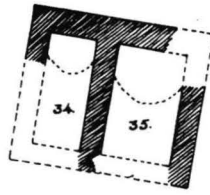
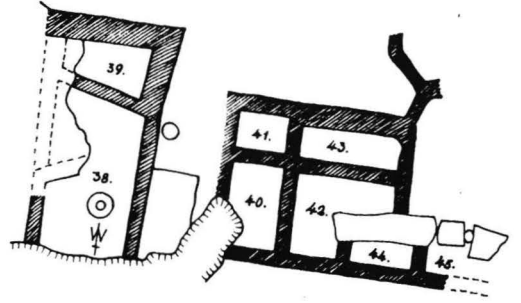
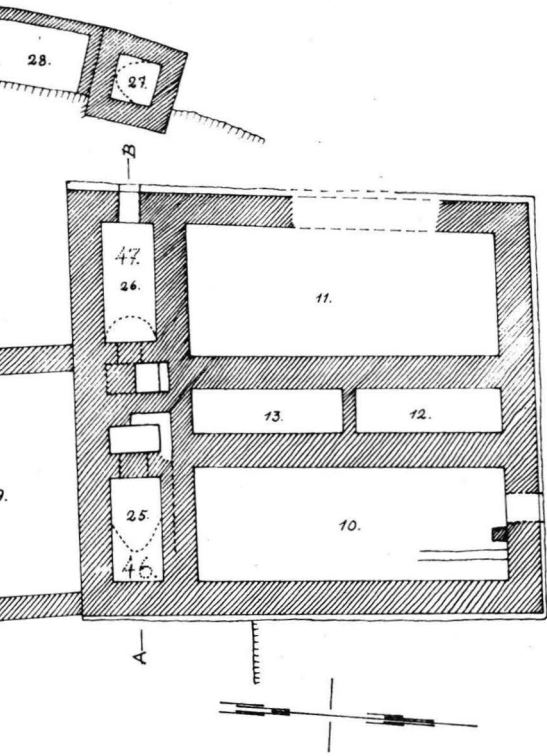

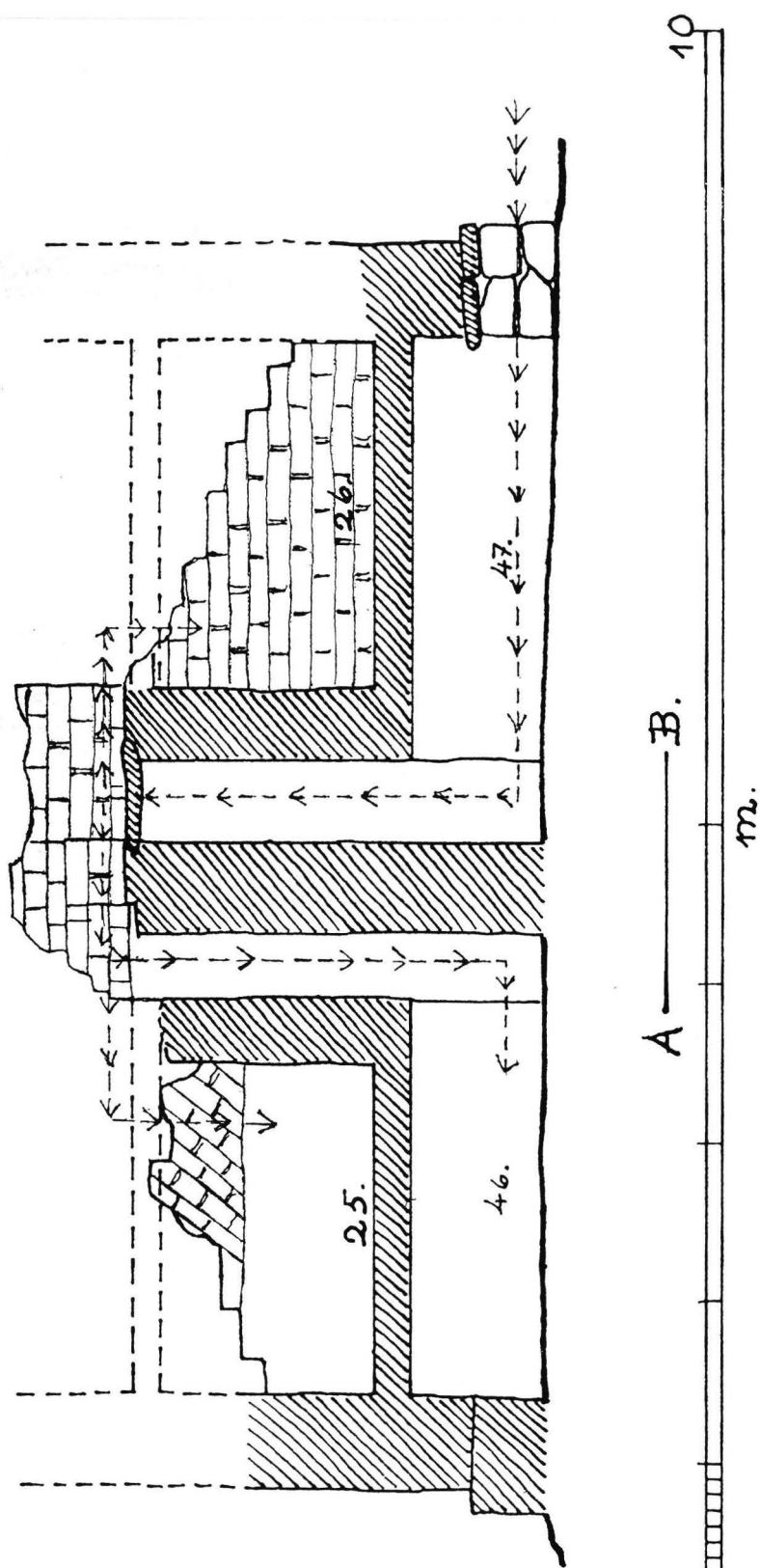

Vault brick size
35 x 16 x 8 cm

Wall brick size
40 x 20 x 8 cm

NUBIA SITE 4

29. Site 4. The vault construction.



1.

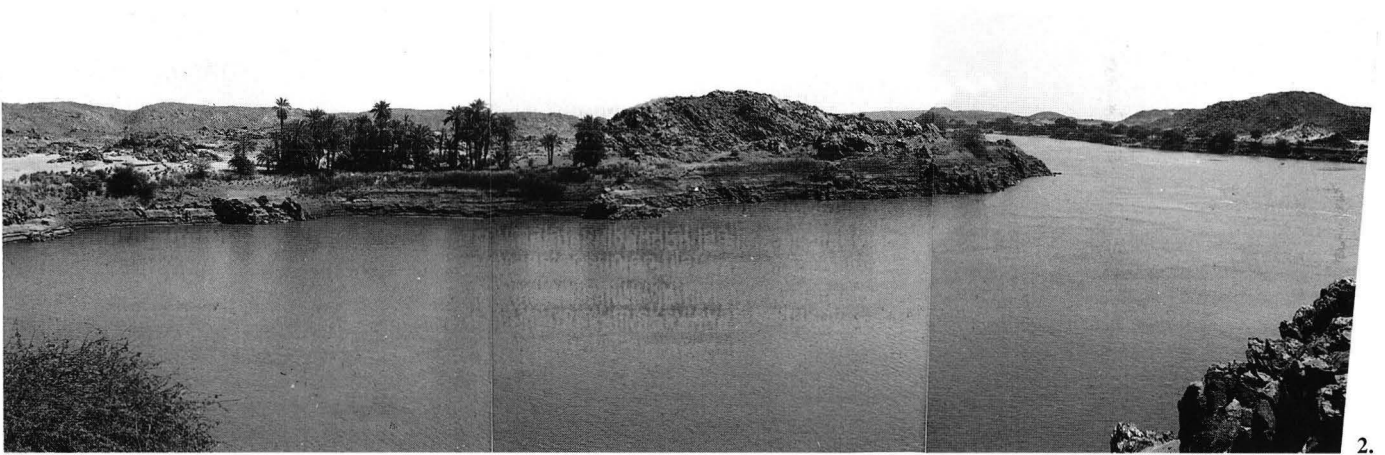

2.



3.

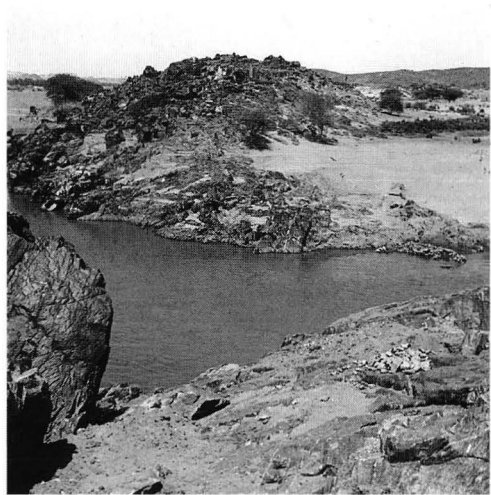

4.

30. Site 4. 1. Aerial view. 2. View towards SE-SSE-S. 3. View to NE. 4. View to S.



1.

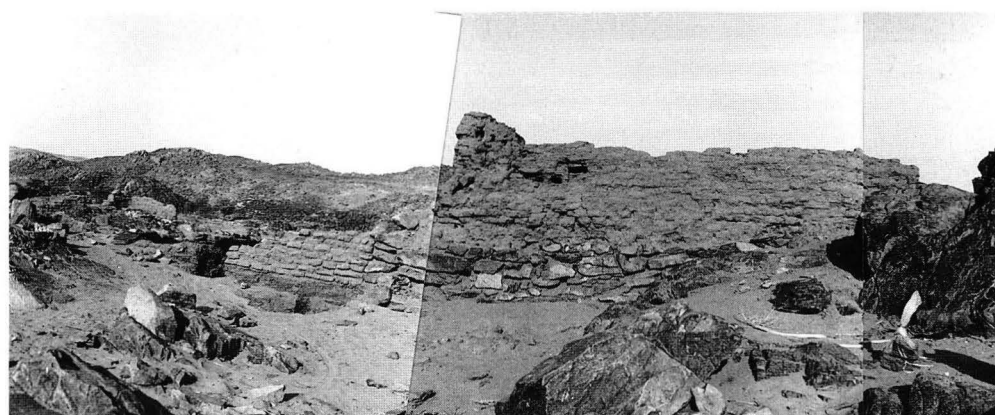

2.



3.



4.

31. Site 4. 1. (left to right) room 31 and room 32 E and N walls. 2. View (left to right) to rooms 14,29,25&10. 3. Room 14, S-wall. 4. Room 10, N-wall.



32. Site 4. 1-2. Room 15 N-wall and E-part. 3. The door between rooms 15&16. 4. Room 21, from N. 5. Room 27, from NE. 6. Passage-wall between rooms 46&47, from NE.

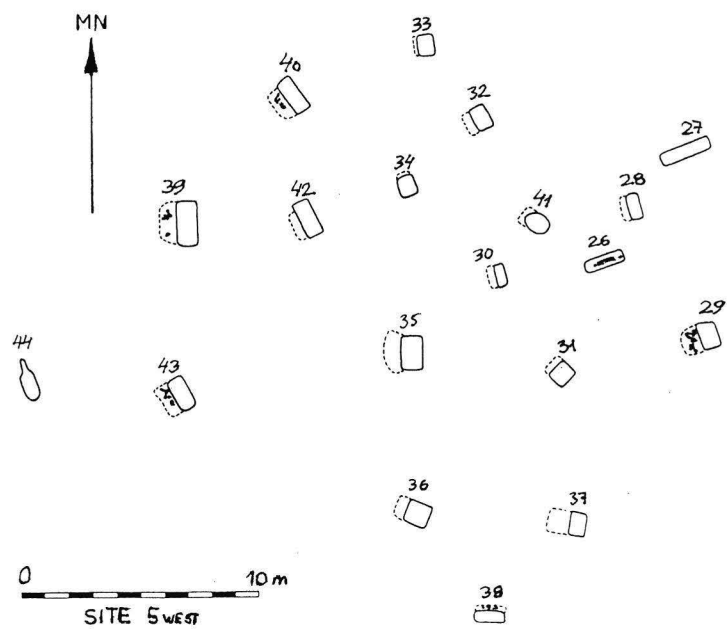
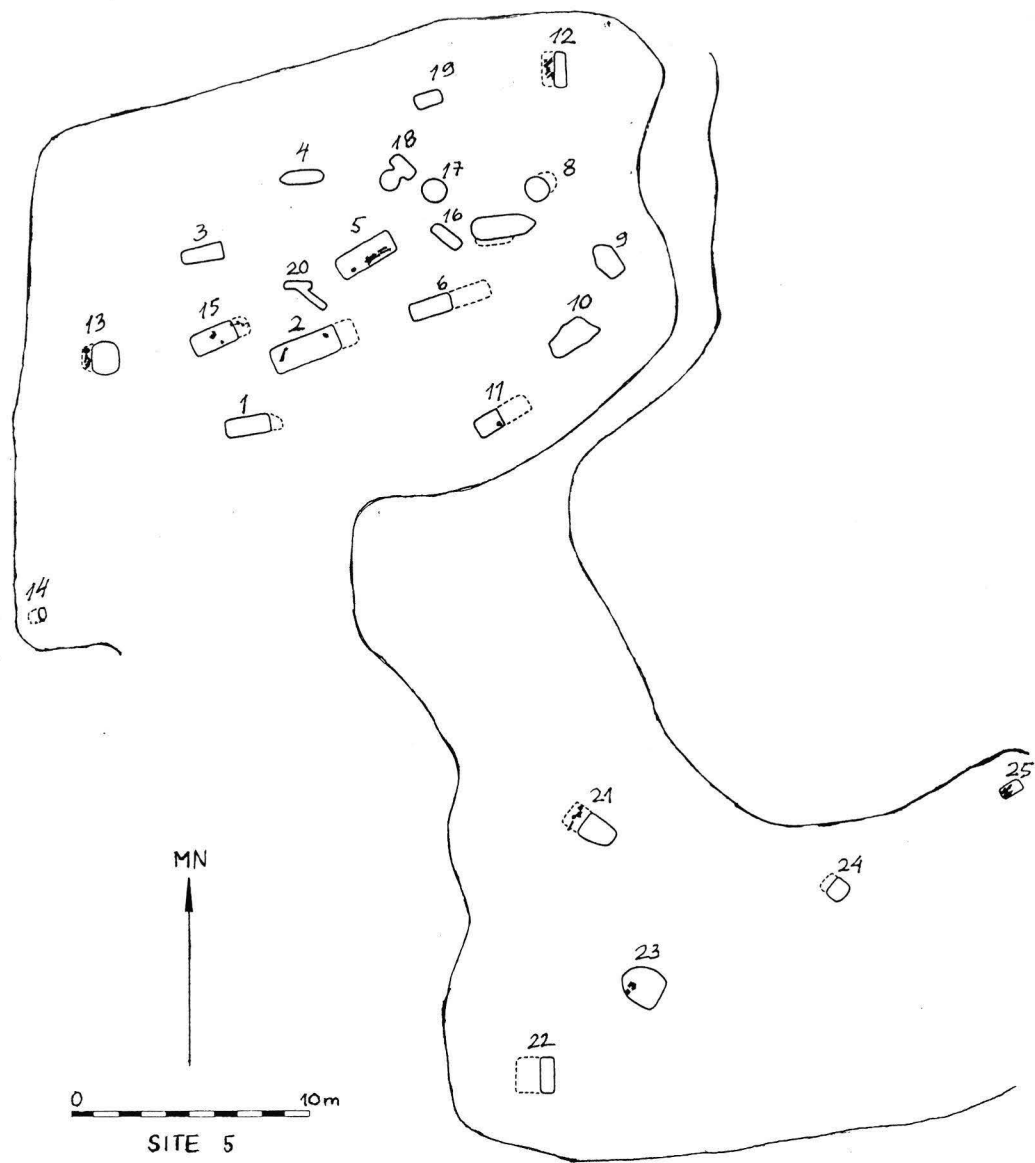

33. Site 5 and 5 West. Plan.

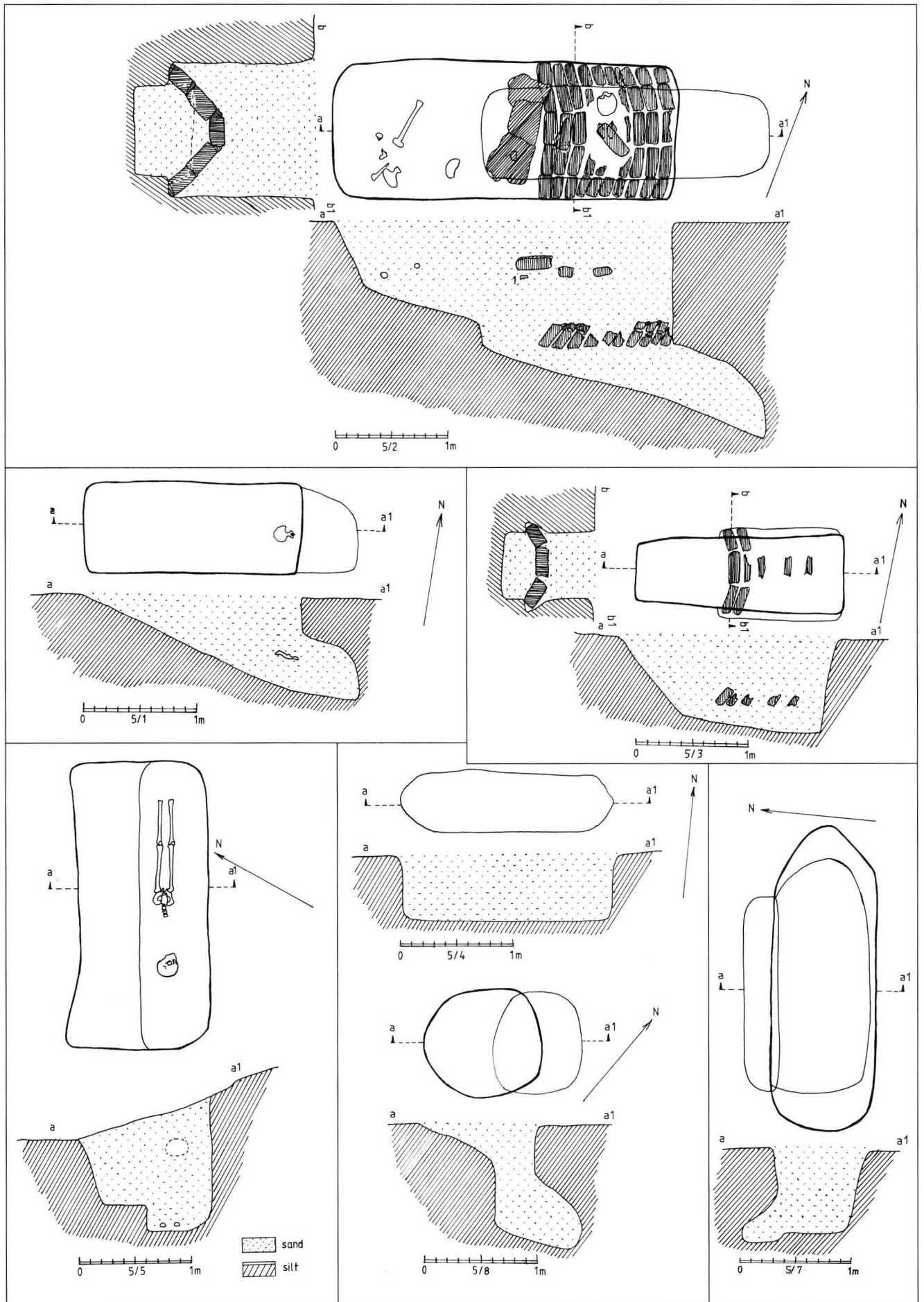

34. Site 5/1-5/7,8.

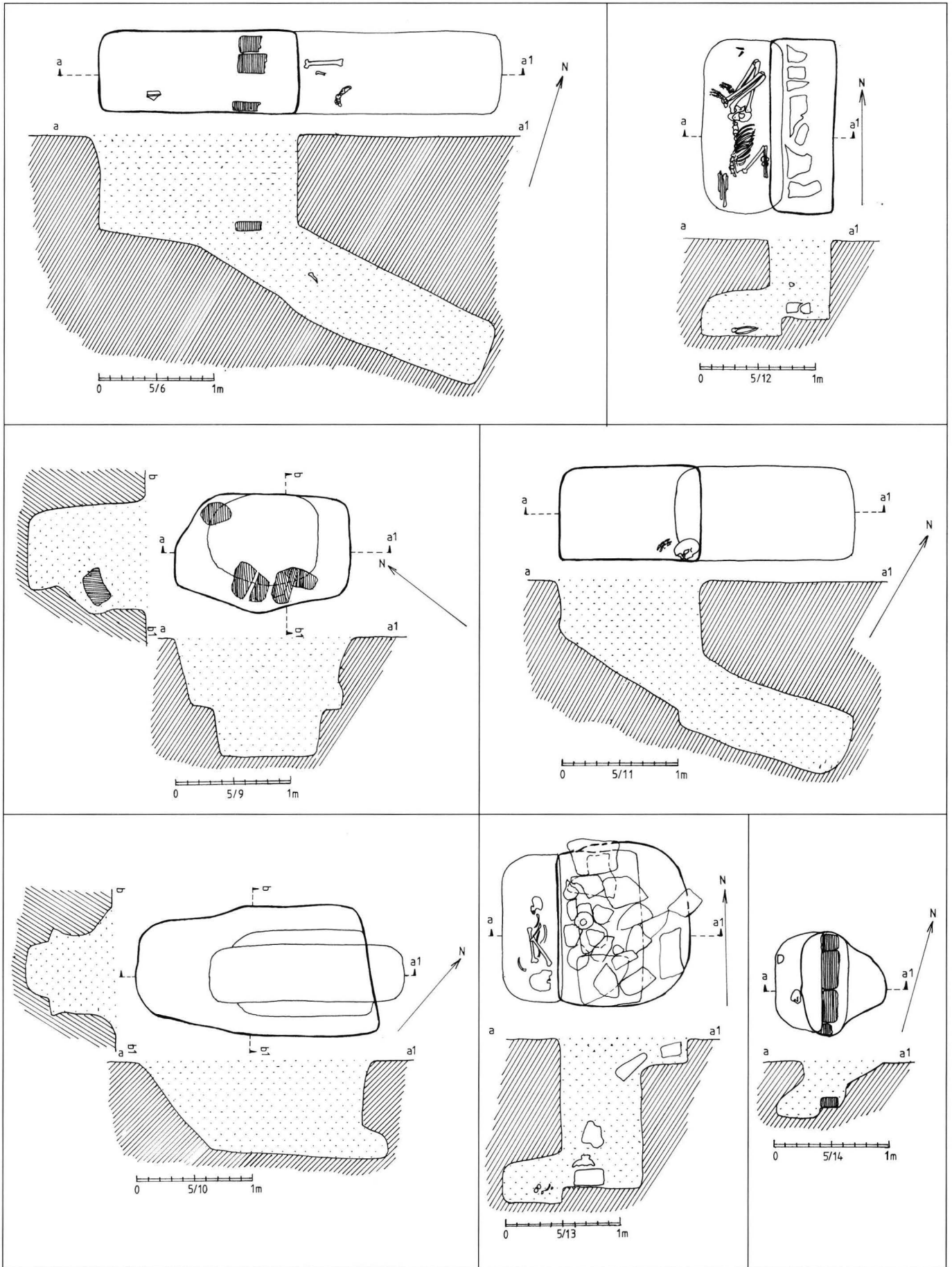

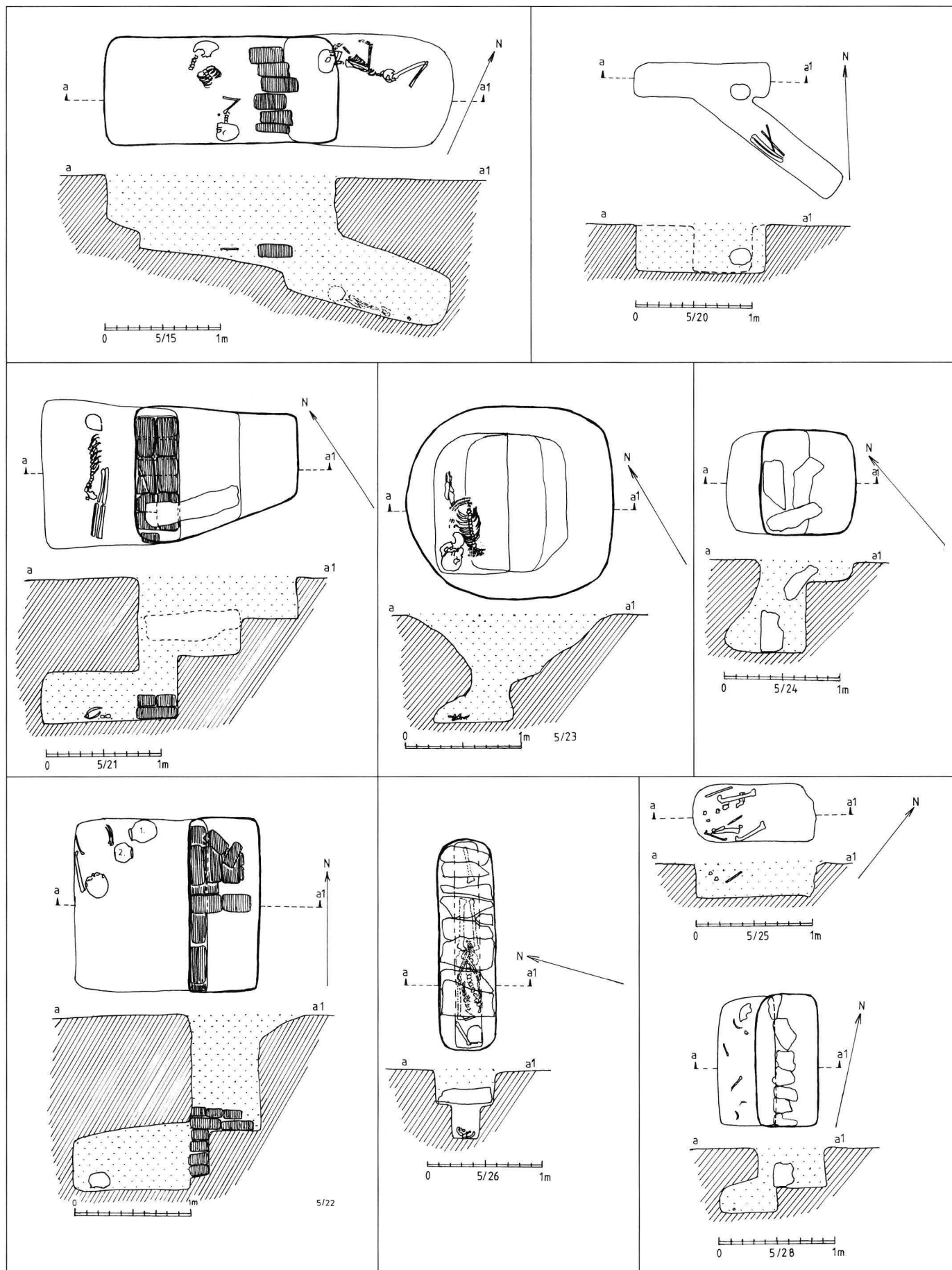

36. Site 5/15,20-26,28.

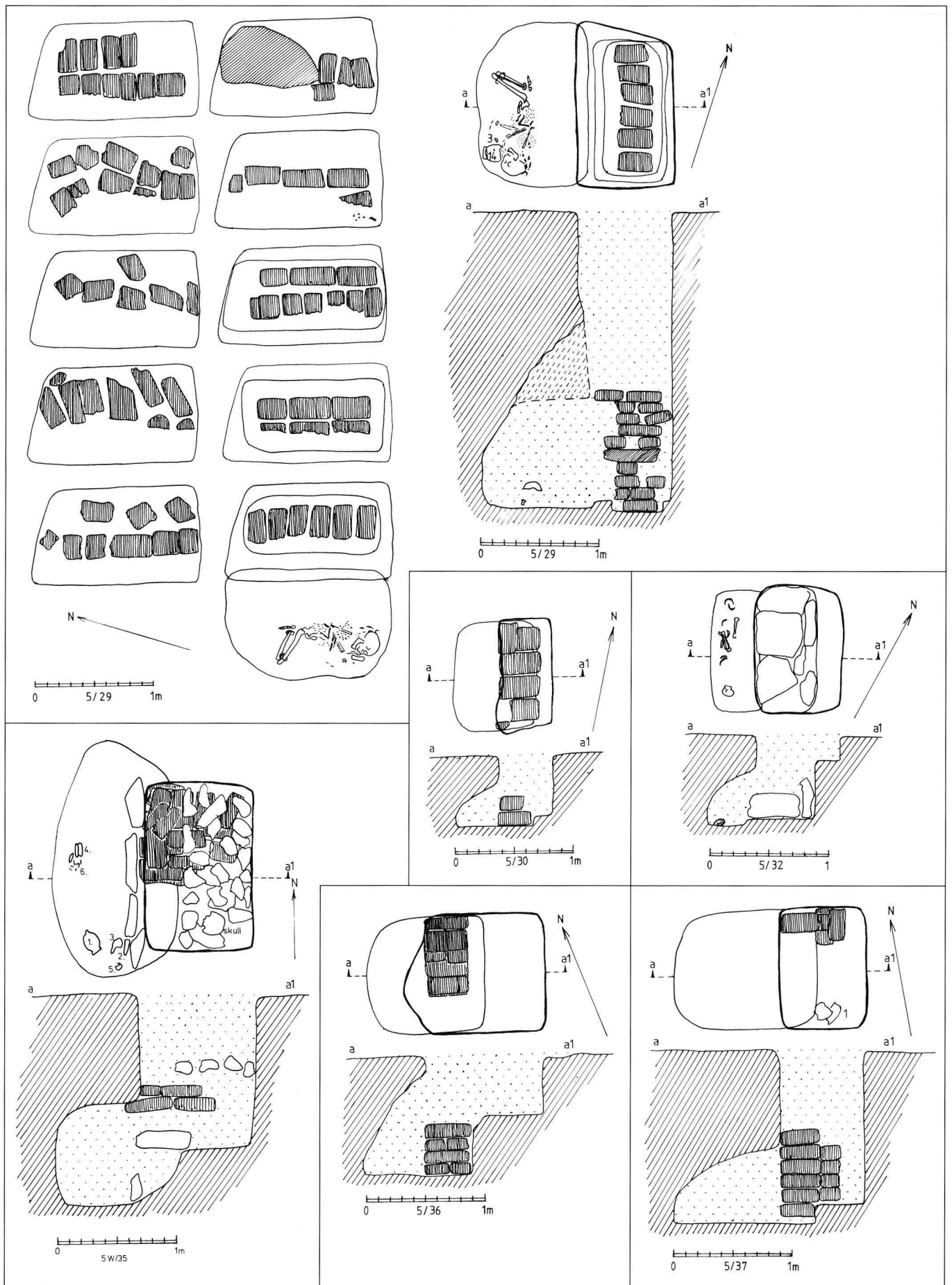

37. Site 5/29,30,32,35-37.

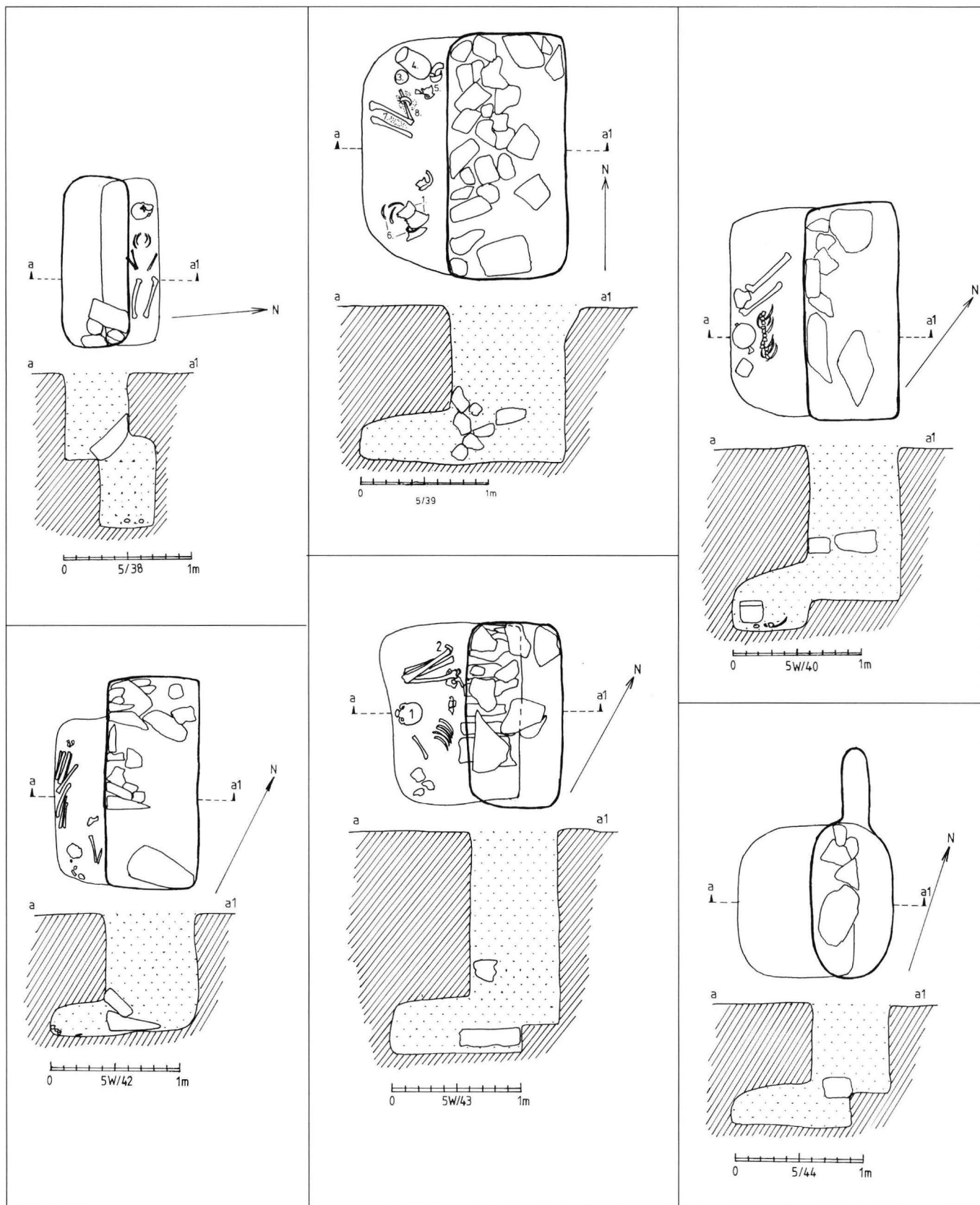

38. Site 5/38-40,42-44.



1.

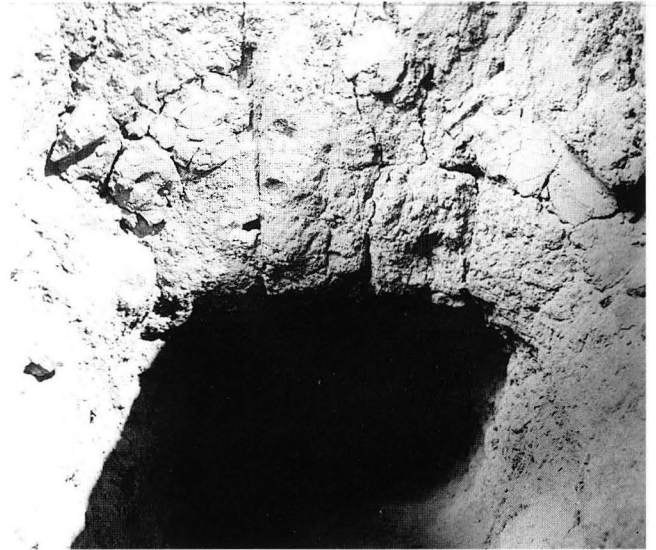

2.



3.



4.



5.



6.

39. Site 5. 1. Under the excavation, from NE. 2. Vault and a niche from E (5/2). 3. Niche and bodies in the shaft, from W (5/15). 4. Upper sealing (5/13). 5. Sealing and a body in the shaft, from SE (5/12). 6. Body and finds in situ (5/40:1-3).

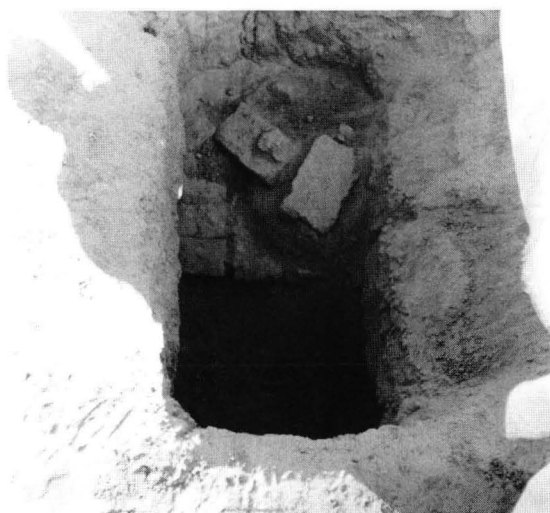

1.

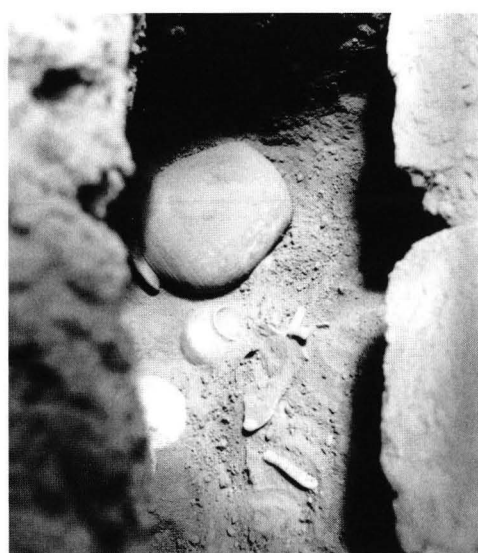

2.

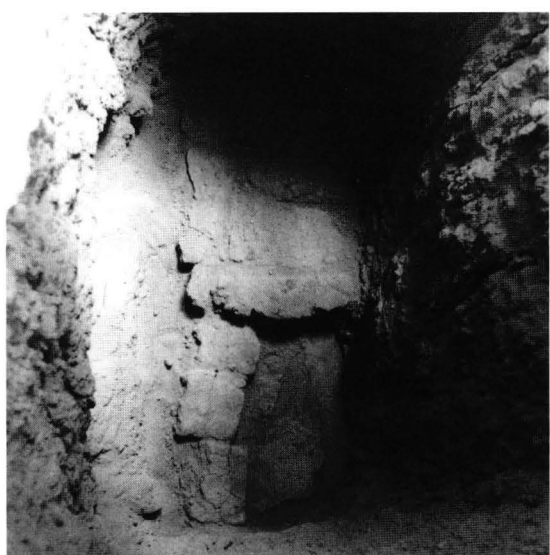

3.

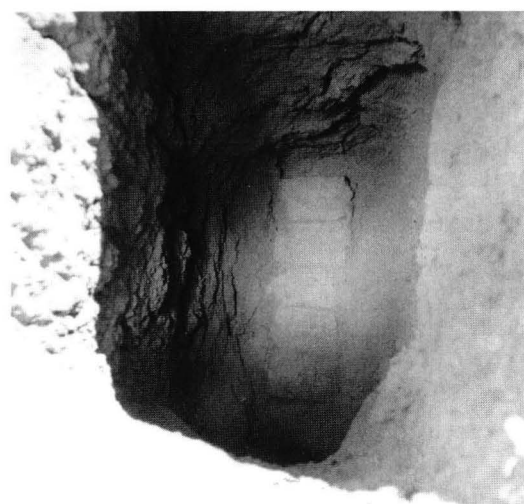

4.



5.



6.

40. 1-2. Sealing and pottery in situ, from S (5/22:1,2). 3-4. Sealings, shift 1 and 10 (5/29). 5-6. Finds in situ (5/29:2,1).

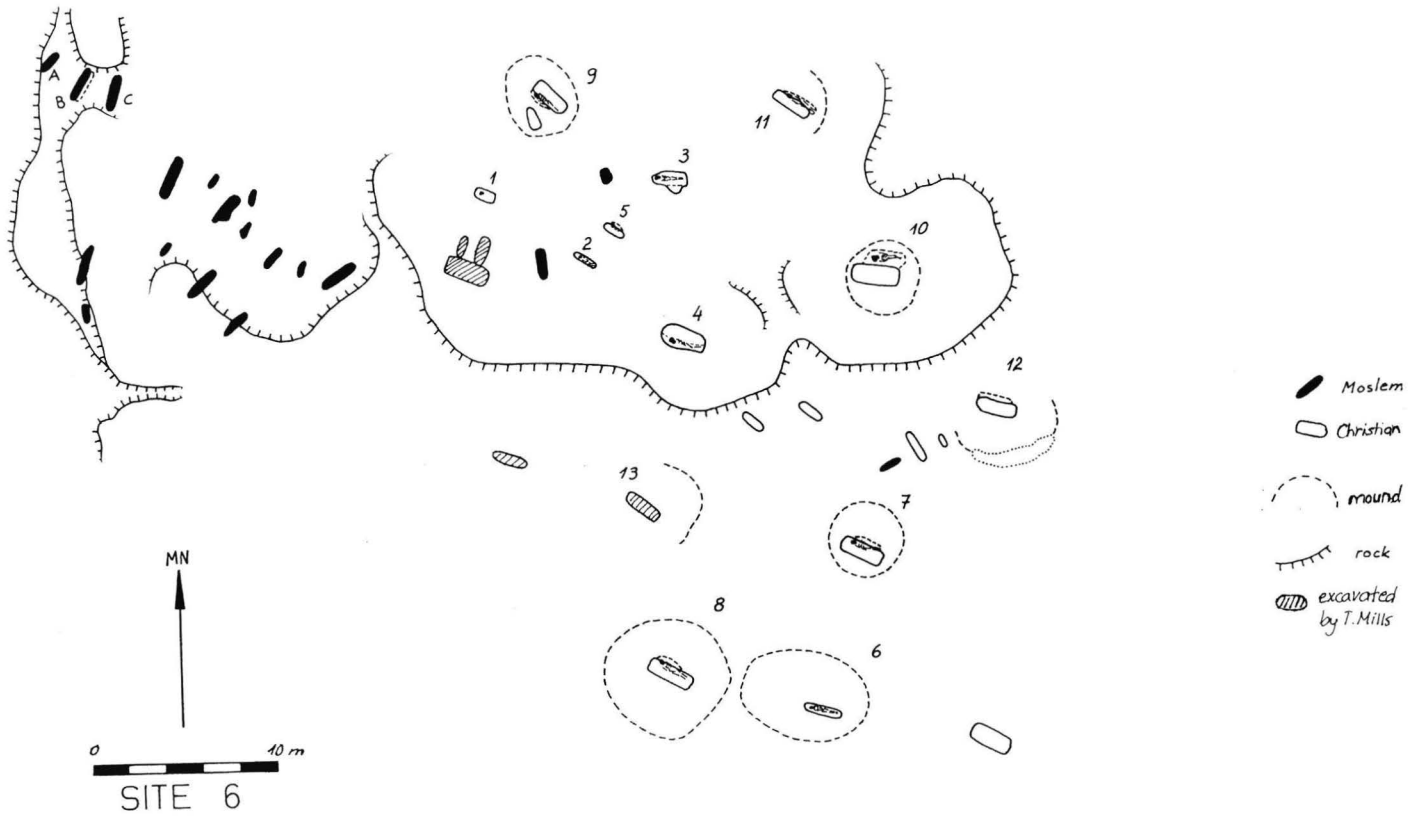

41. Site 6. Plan.

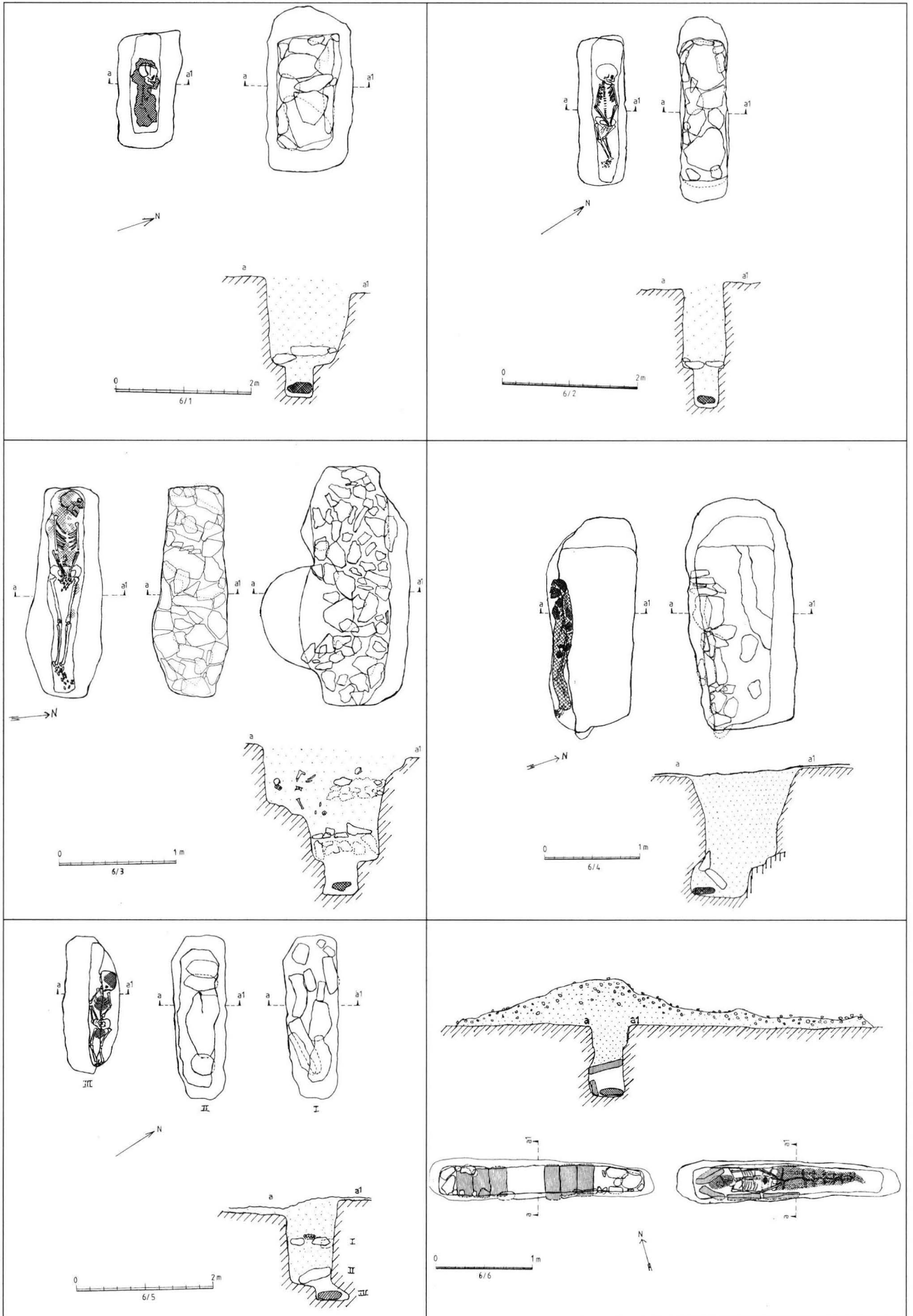

42. Site 6/1-6.

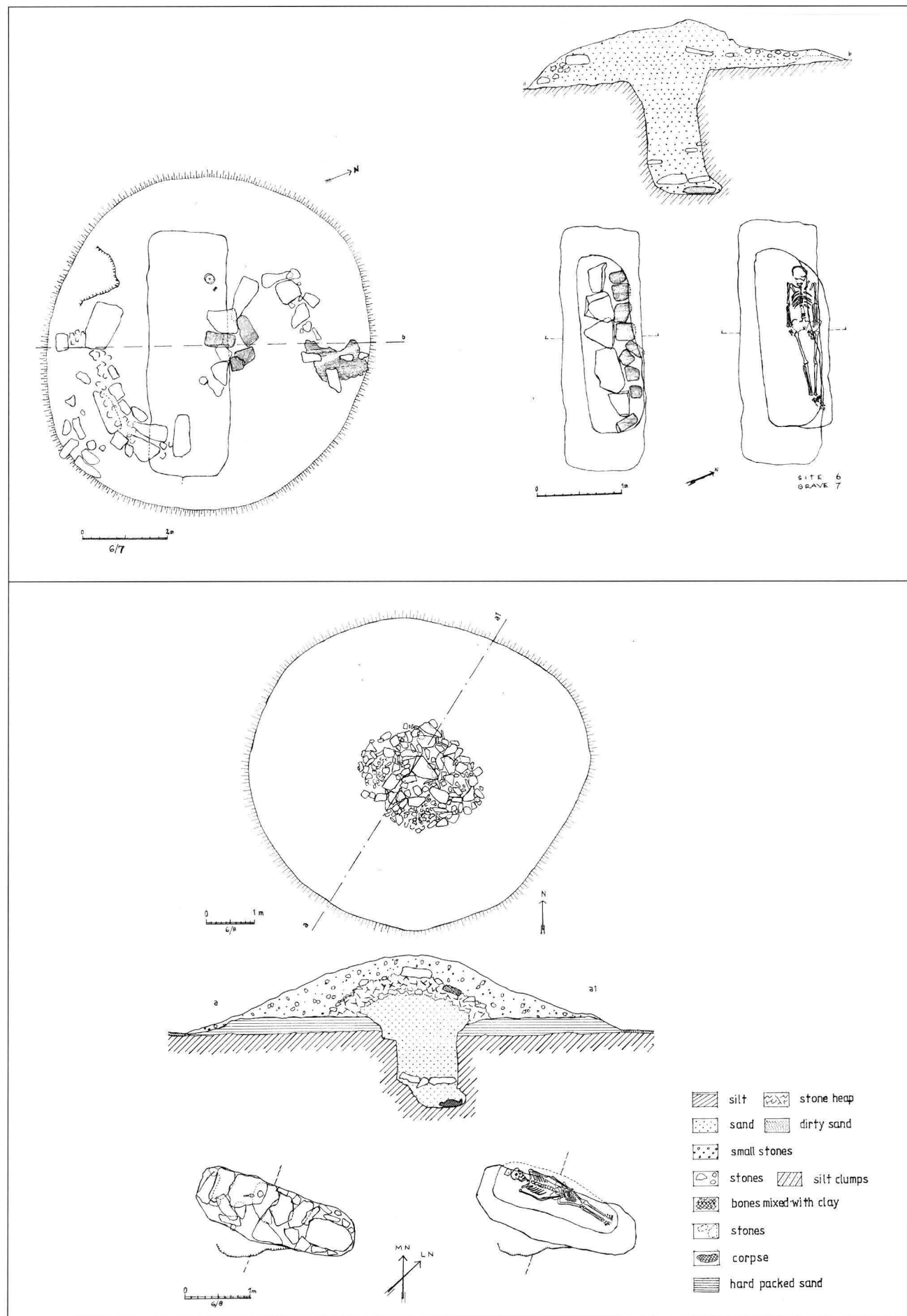

43. Site 6/7-8.

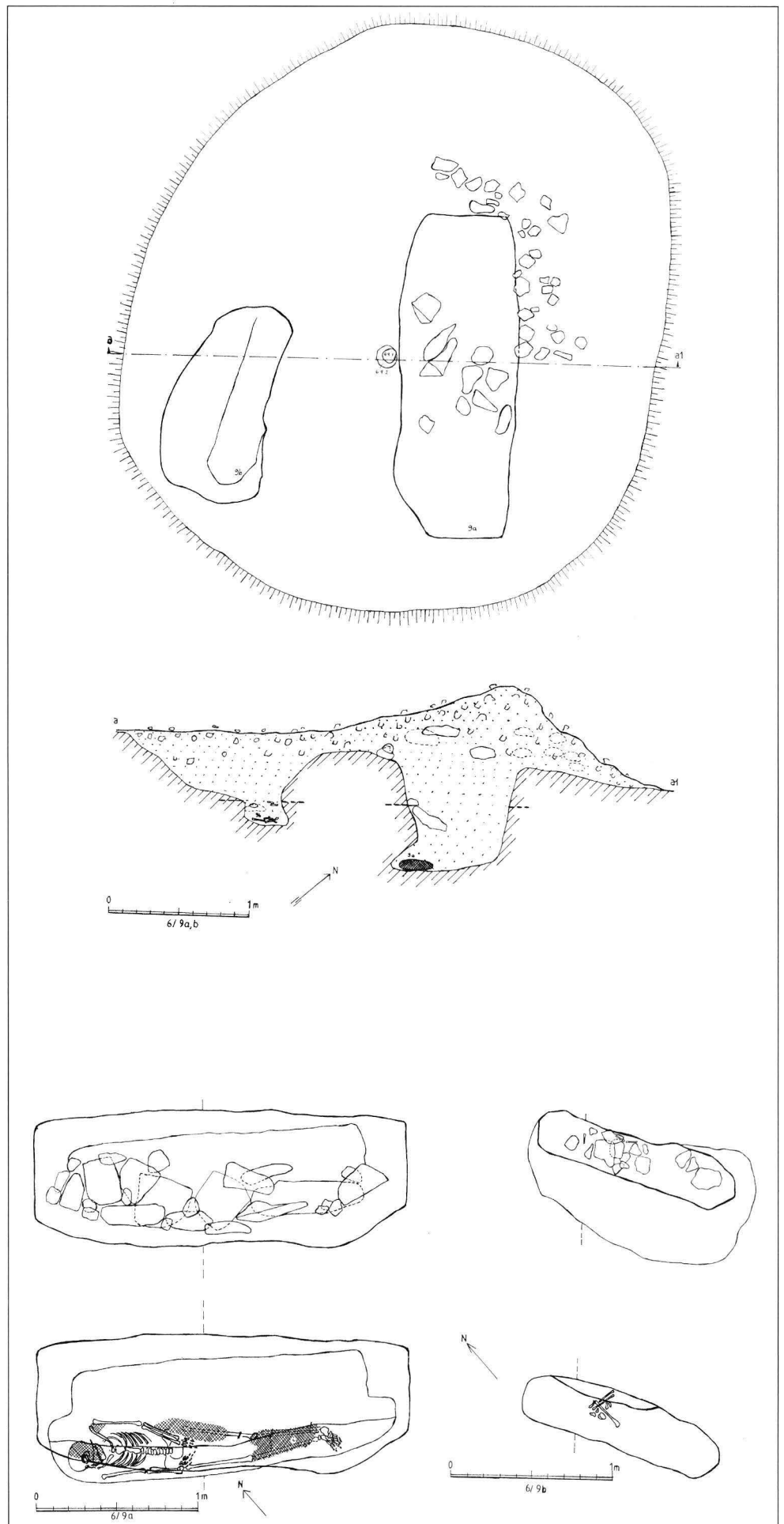

44. Site 6/9a,b.

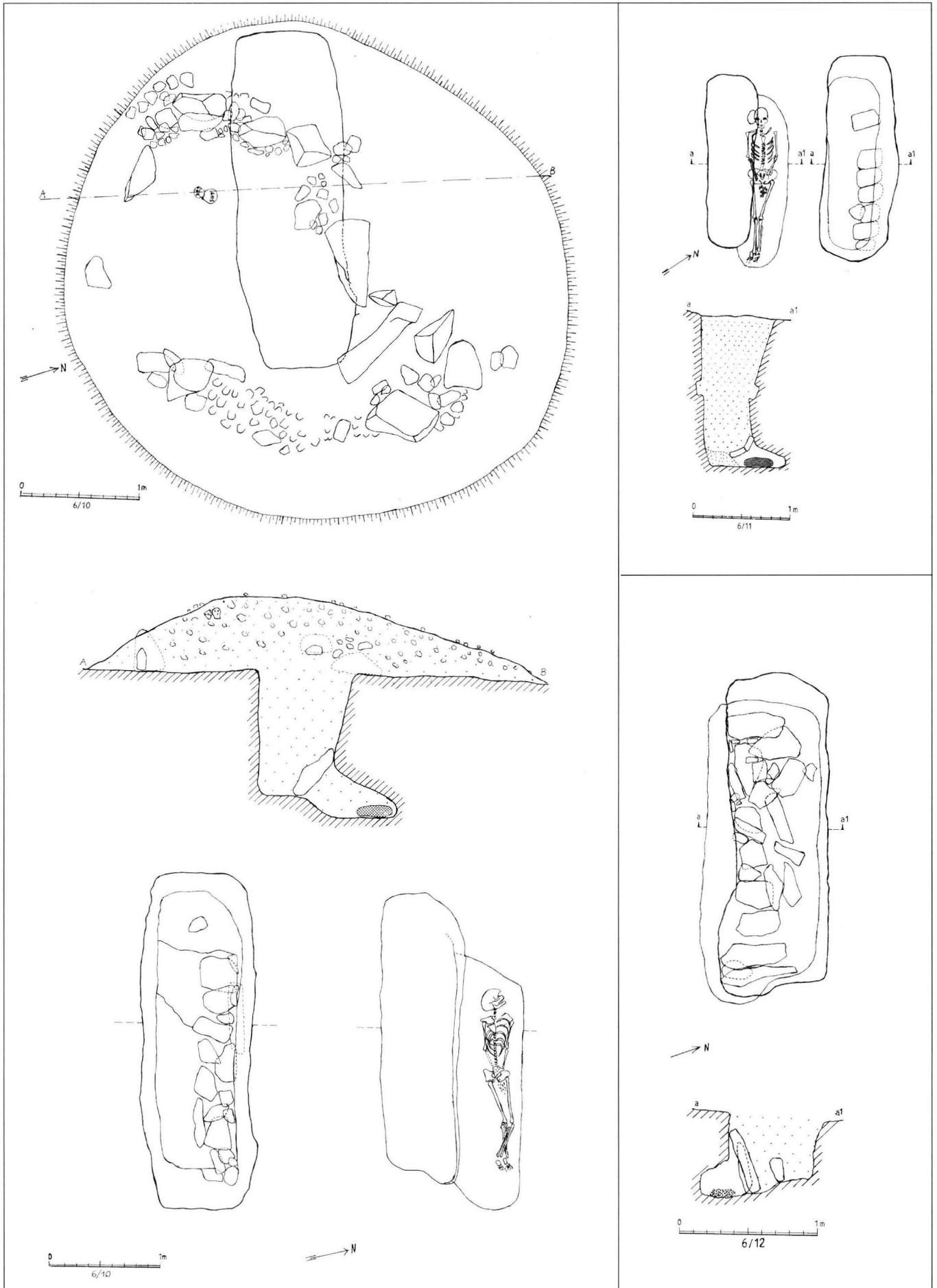

45. Site 6/10-12.

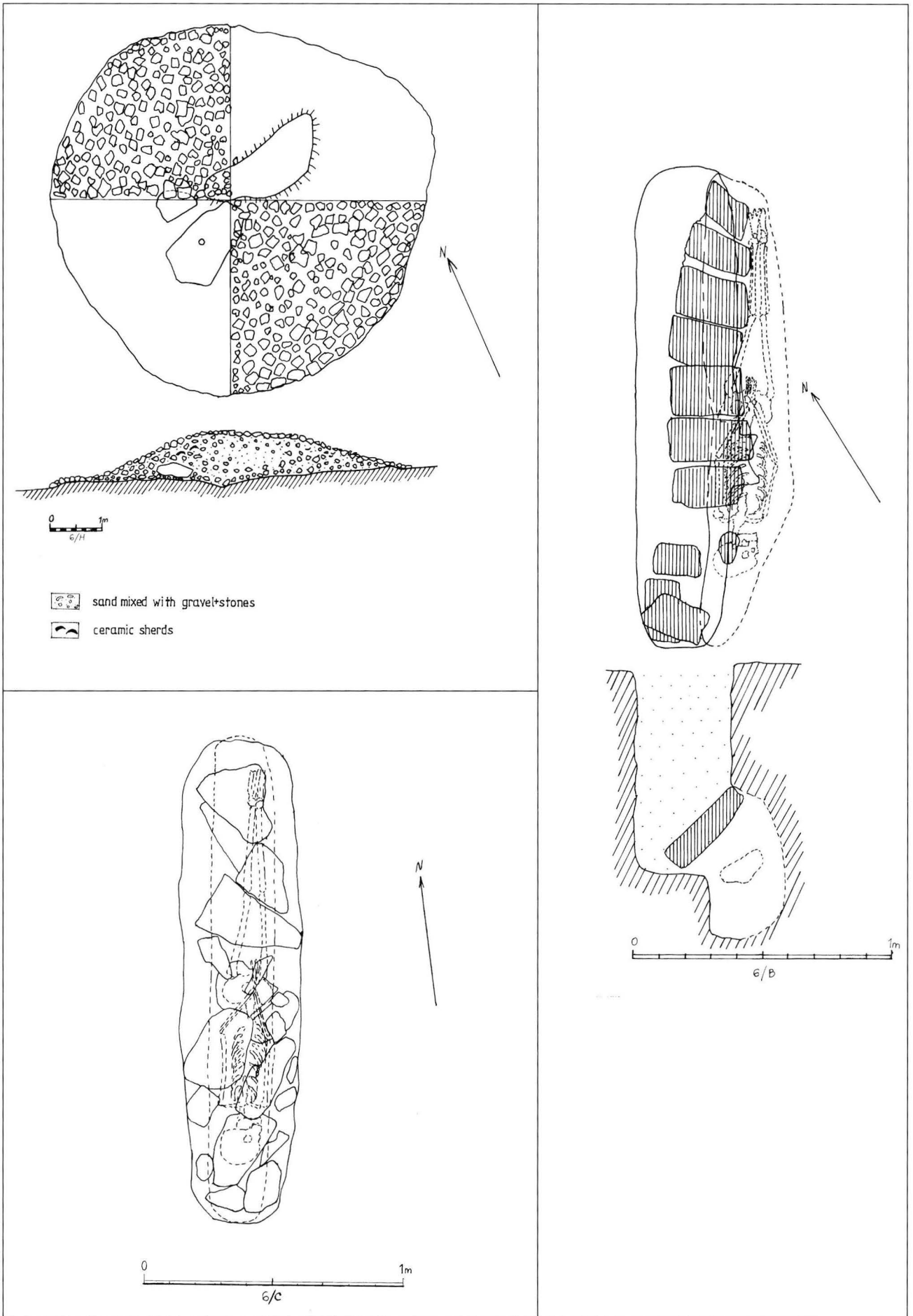

46. Site 6. Graves B and C and structure of the mound H.



1.

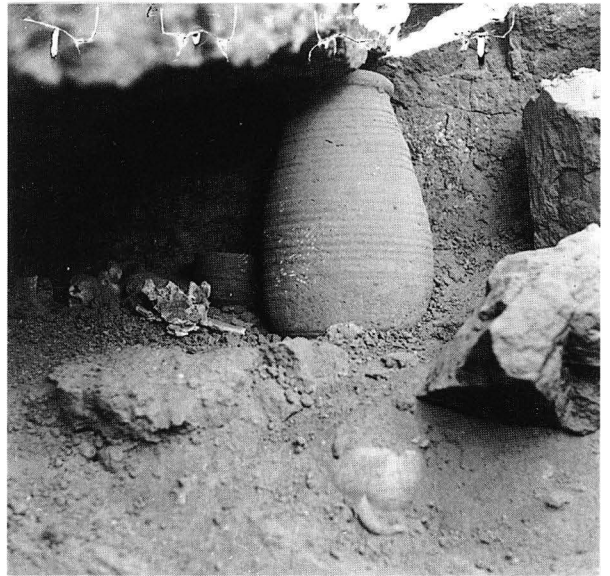

2.



3.



4.

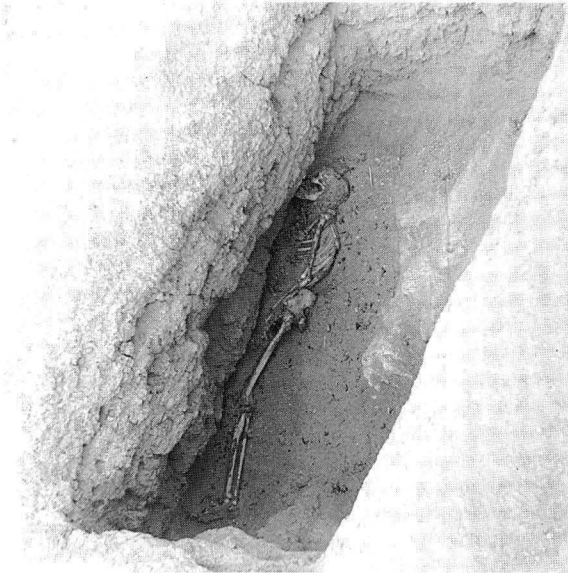

5.



6.

47. 1–2. Sealing and pottery in situ (5/39:3,4). 3. View over the site 6. 4. Sealing, 2nd layer (6/3). 5–6. Body in the shaft and a detail of the rug (6/4).

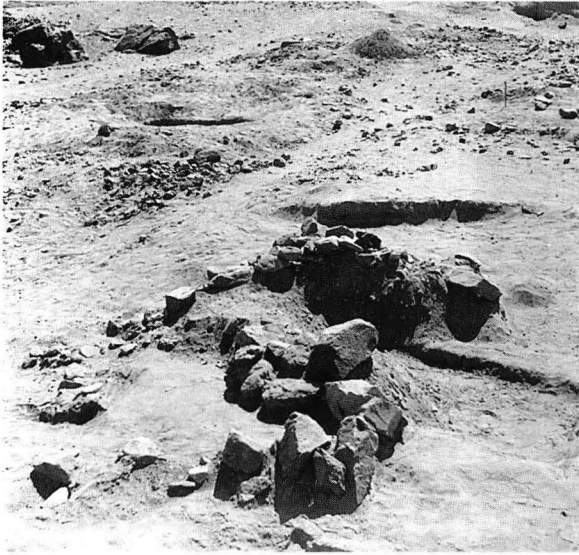

1.



2.



3.

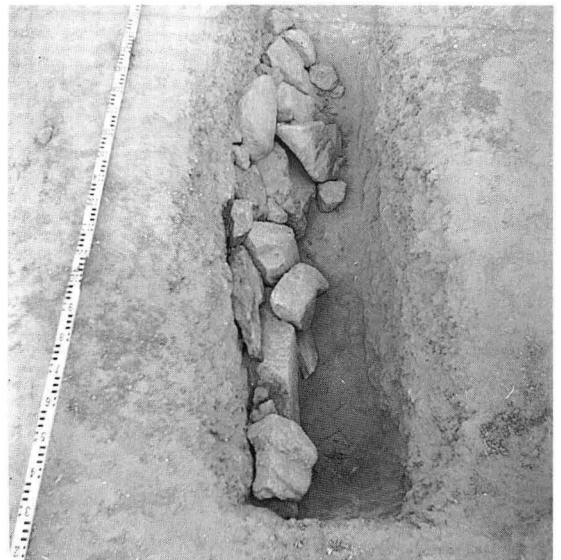

4.



5.



6.

48. 1-2. Tumulus, from N and pottery in situ (6/7:1,2). 3. Tumulus, from NW (6/8). 4. Sealing (6/9a). 5. Traces of tumulus (6/10). 6. Tumulus H, E from the site (6/H).

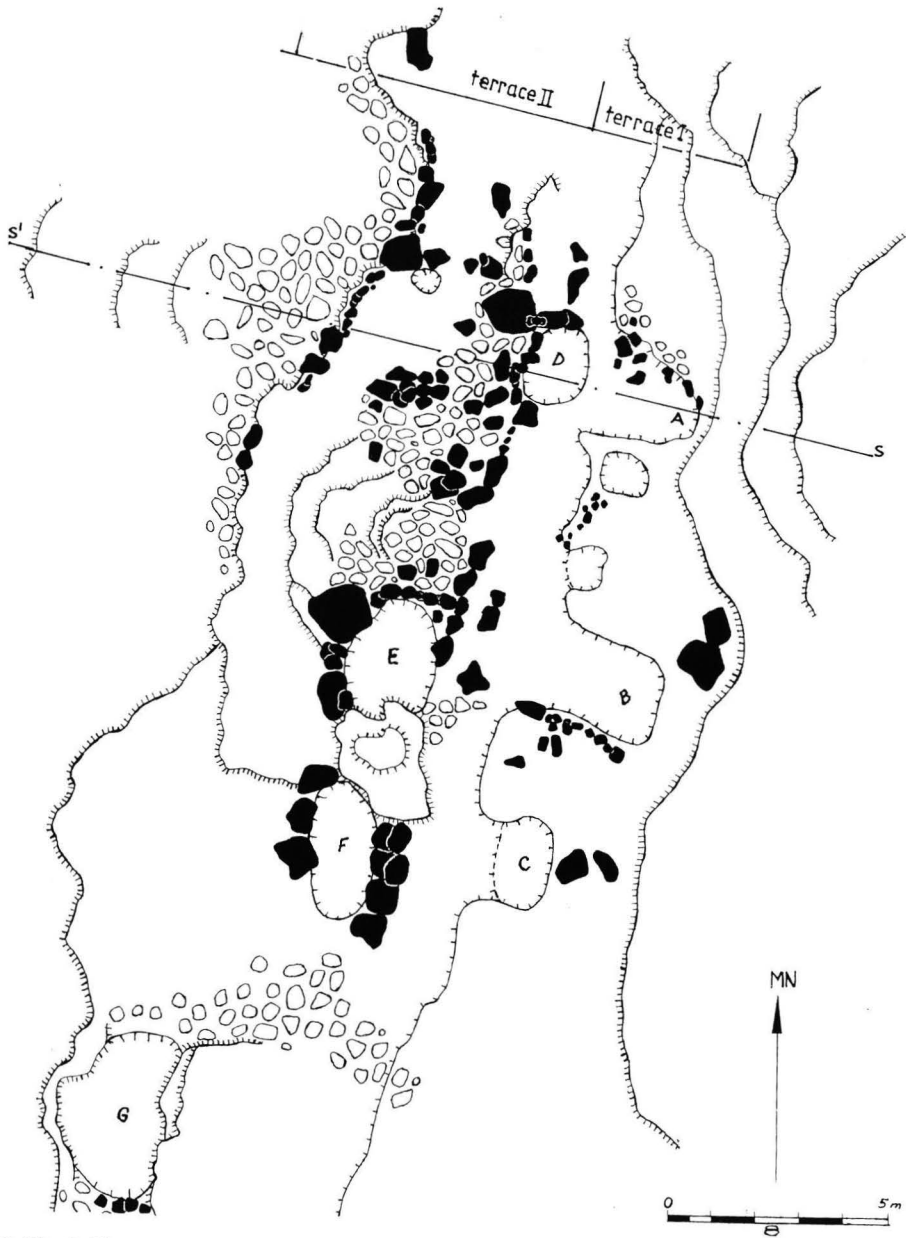

49. Site 8. Plan.

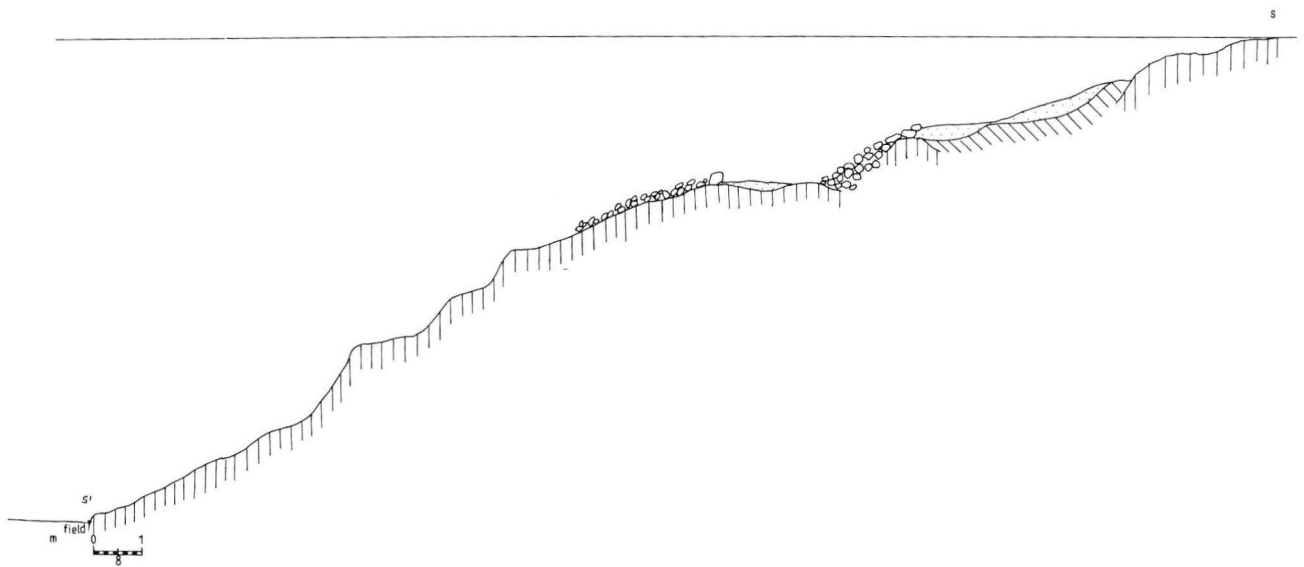

50. Site 8. Profile plan.

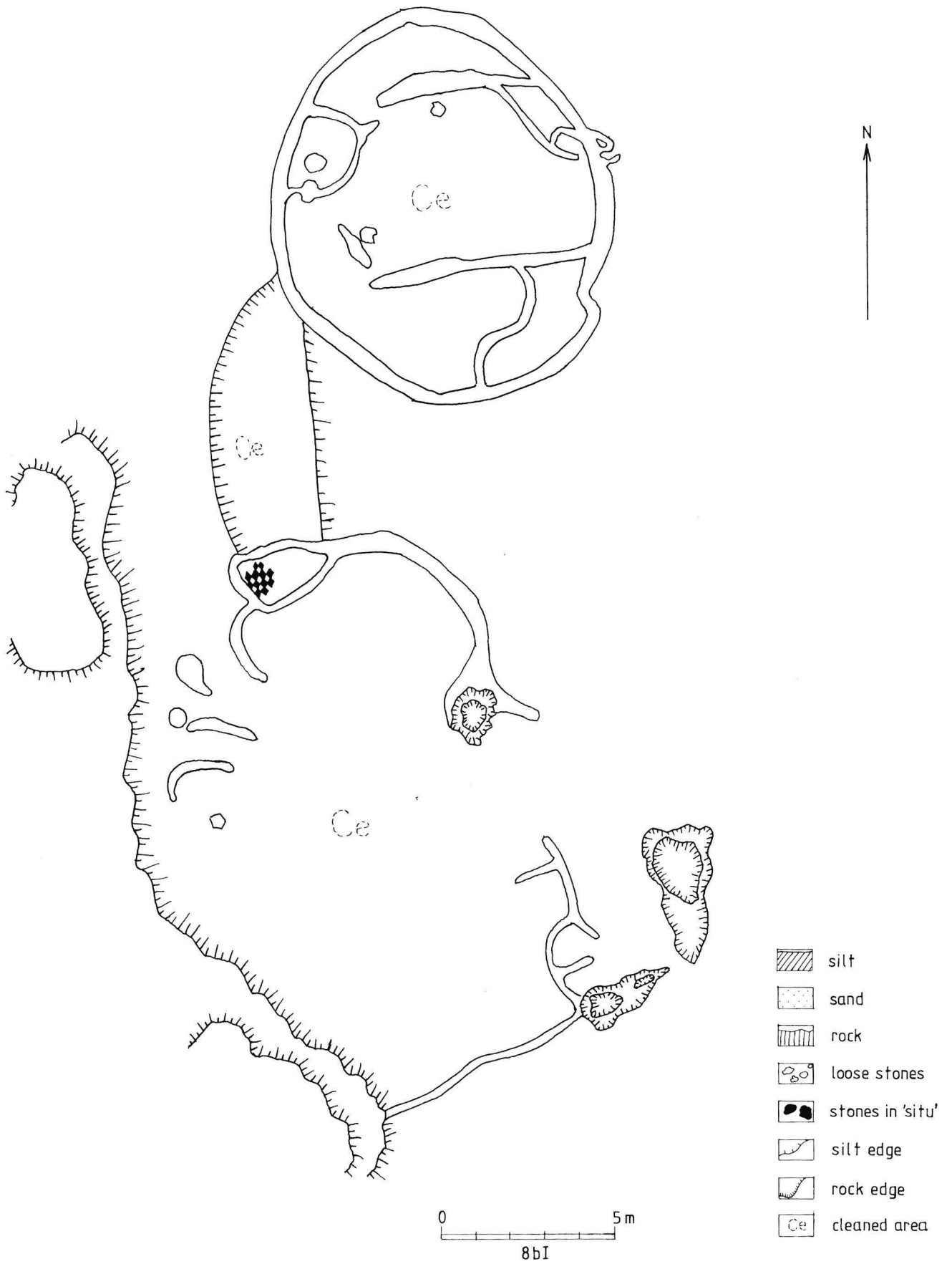

51. Site 8. The terrace I.



1.



2.

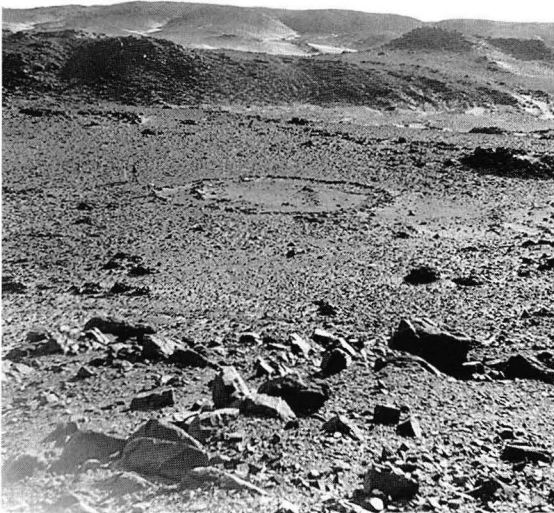

3.



4.



5.



6.

52. 1. Site 6, the middle stone of tumulus H, from W. 2-3. View from N of the site 8 and the "hut bottom" on the mountain top, from W. 4. Site 9, from S. 5. Site 10, after the excavation, from S. 6. Body in the shaft (10/10B).

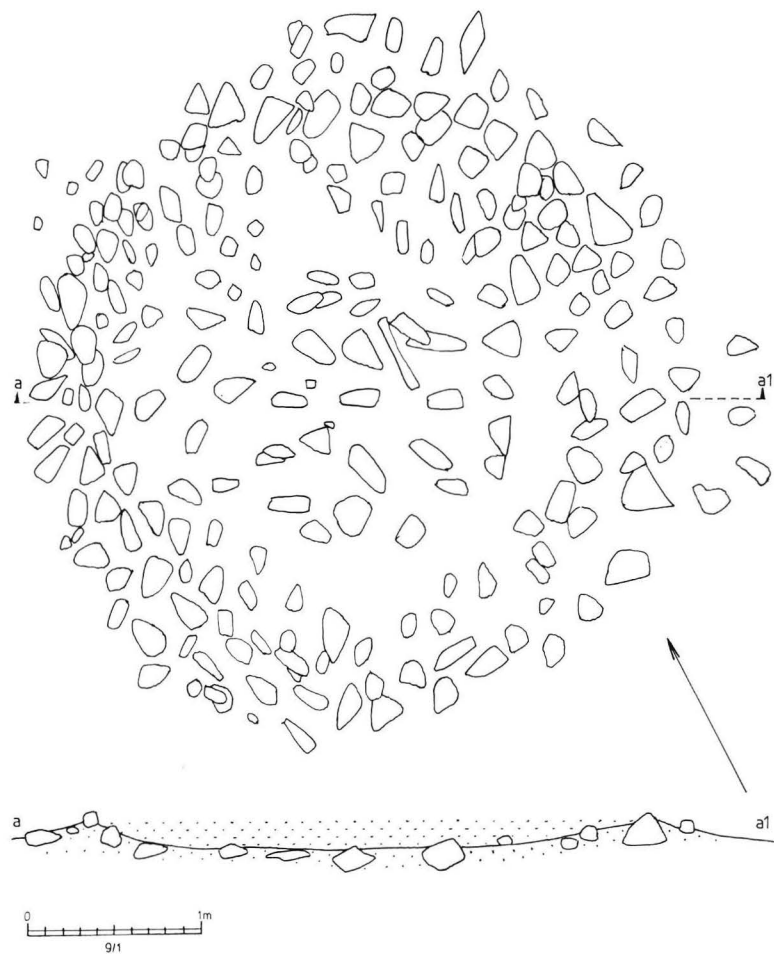
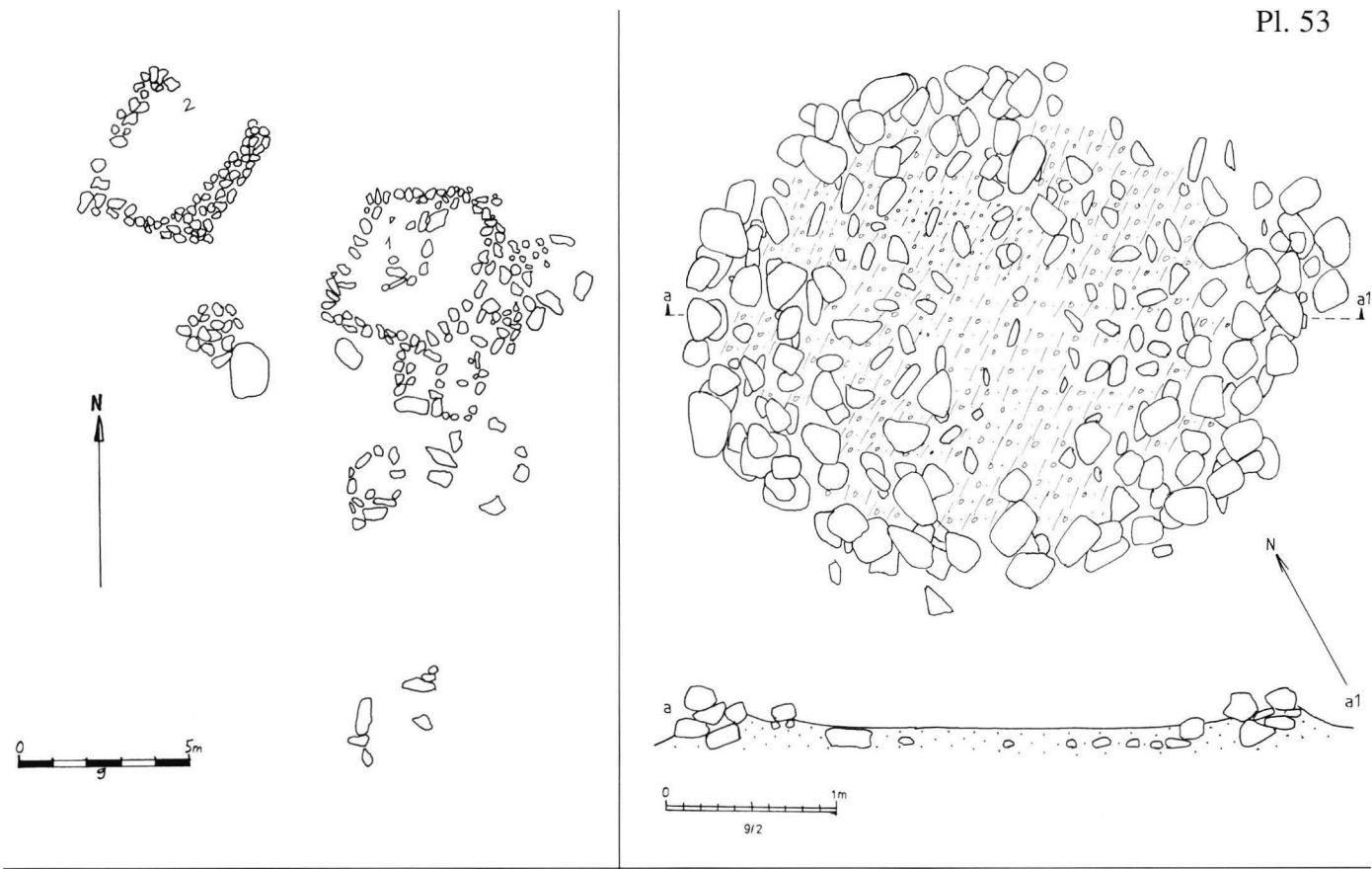

53. Site 9. Plan. Hut bottoms 1 and 2.

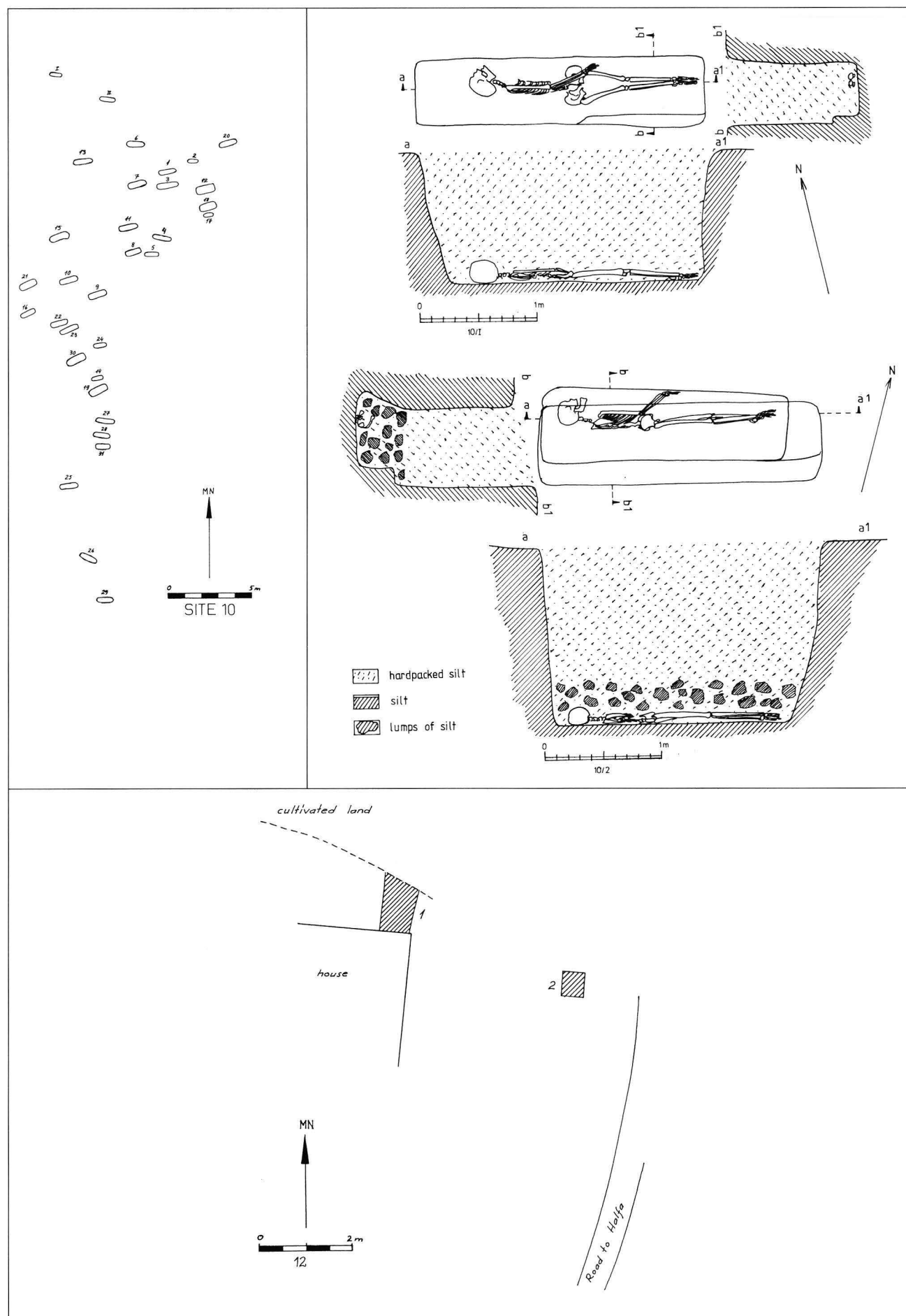

54. Site 10. General plan and 10/1,2. Site 12. Topo sketch.

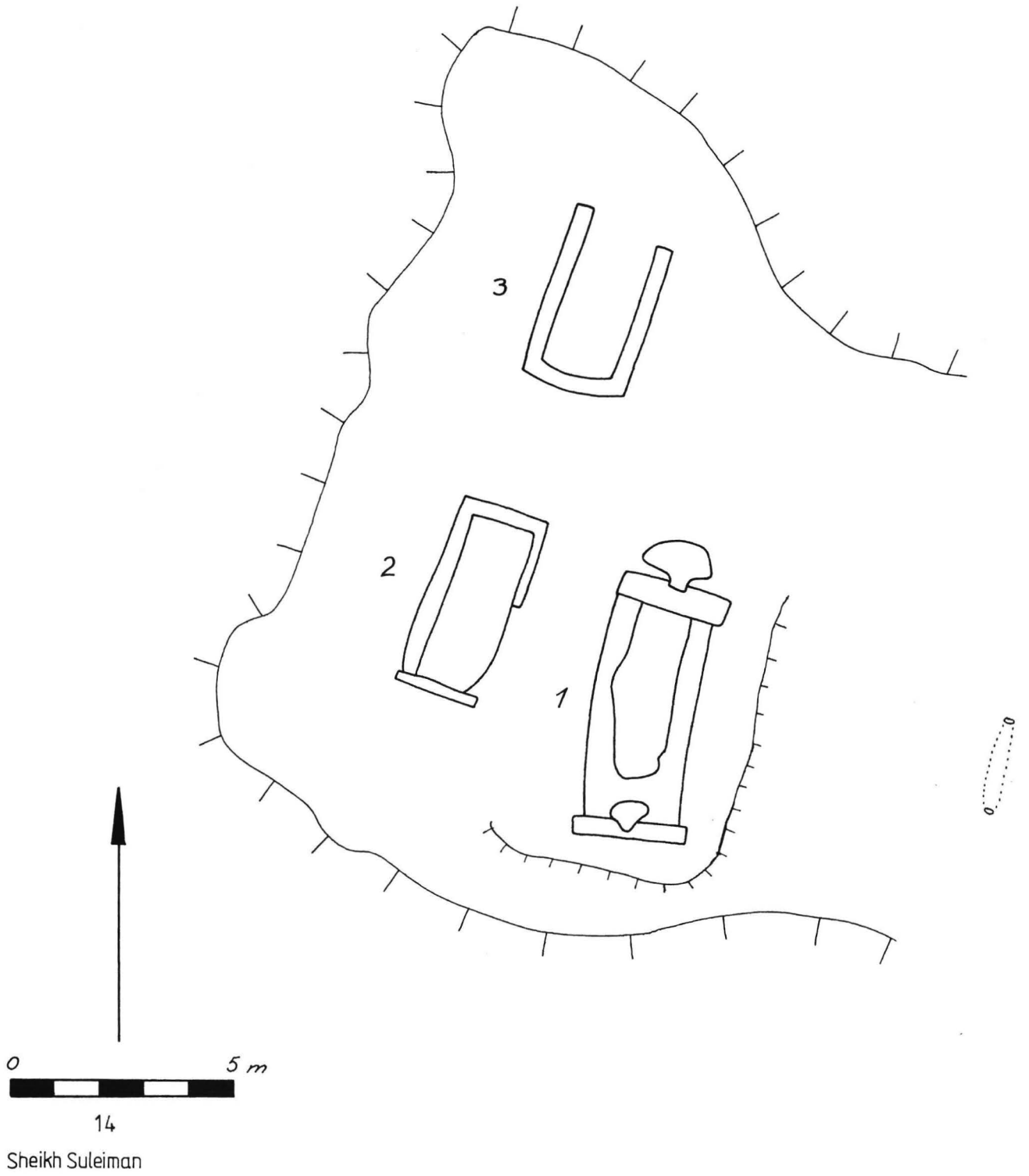

55. Site 14. Sheikh Suleiman. Plan.

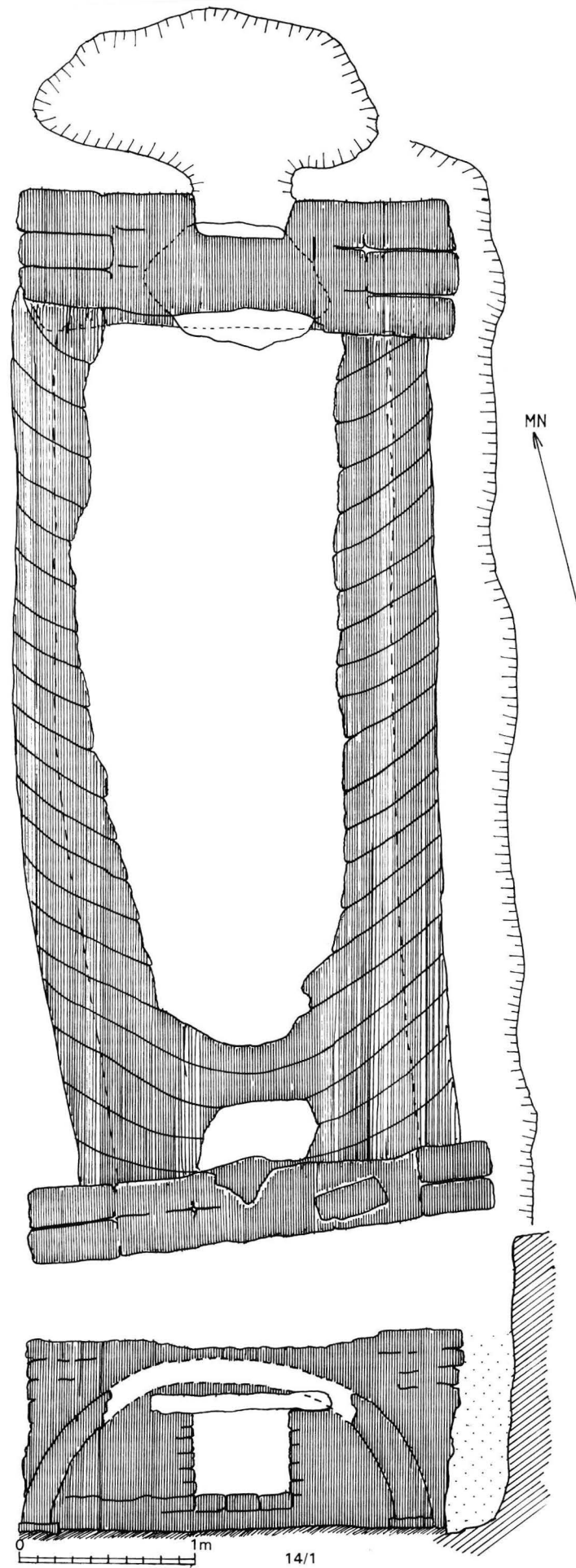

56. Site 14/1.

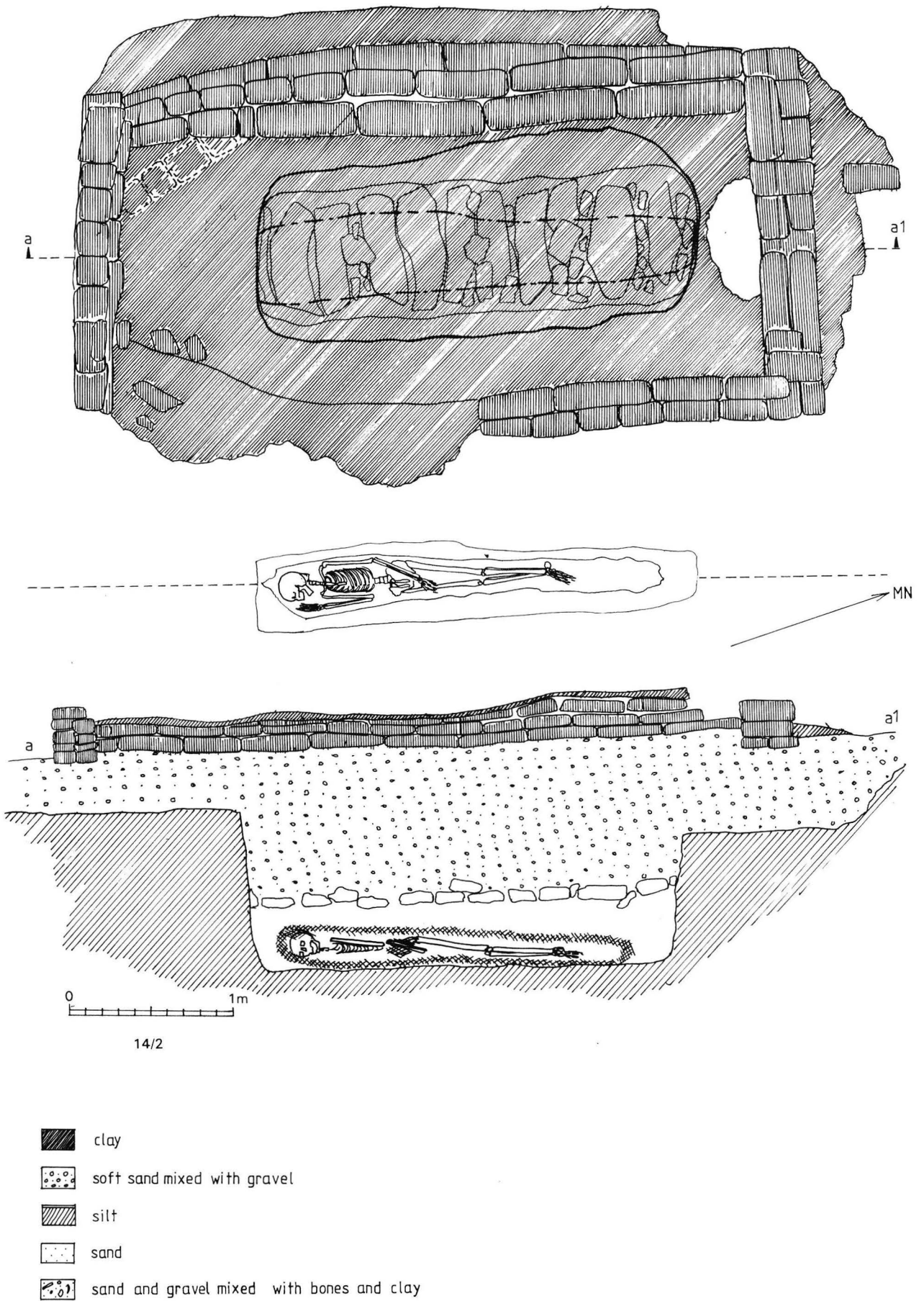

57. Site 14/2.

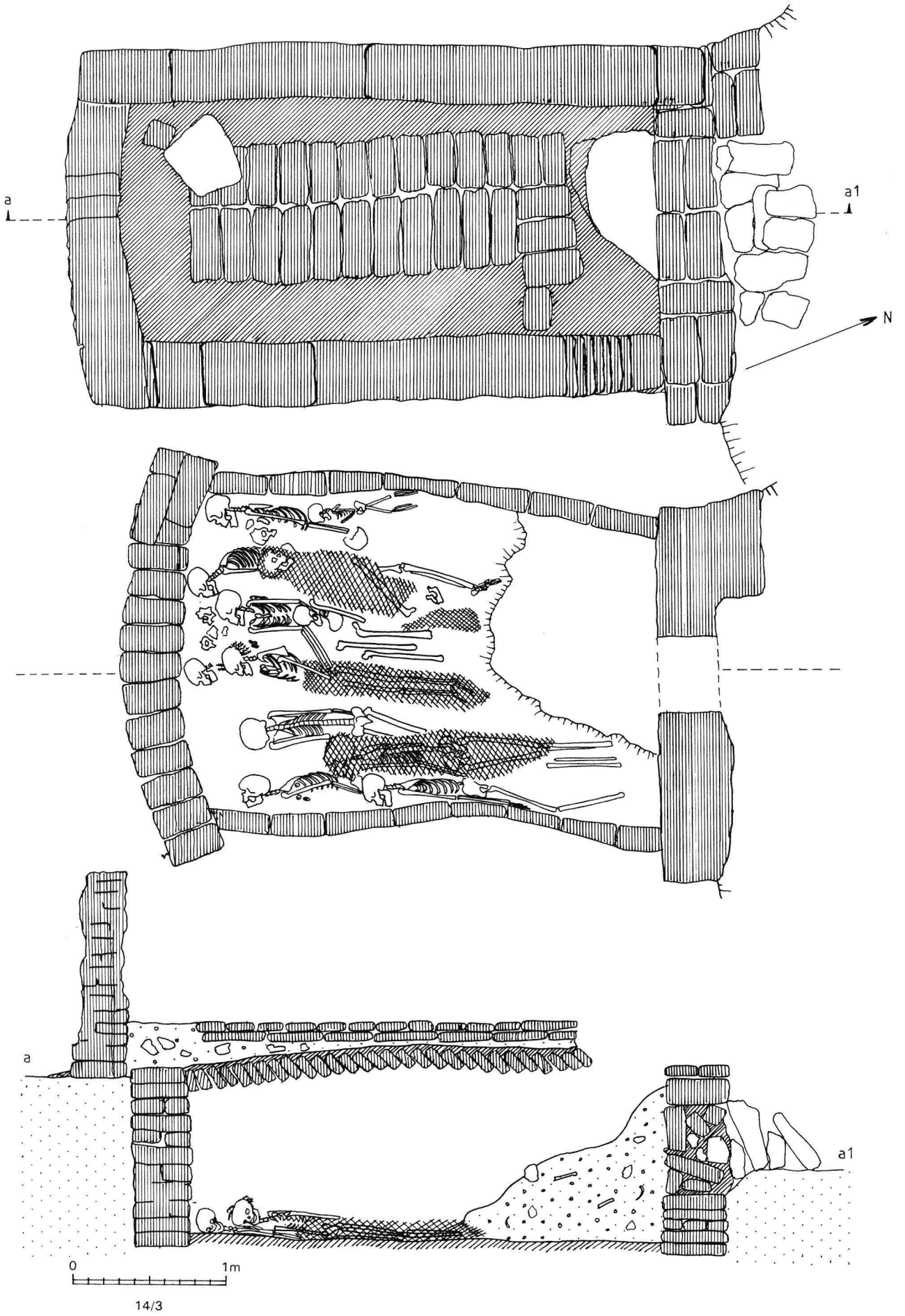

58. Site 14/3.

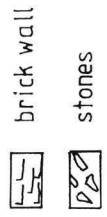
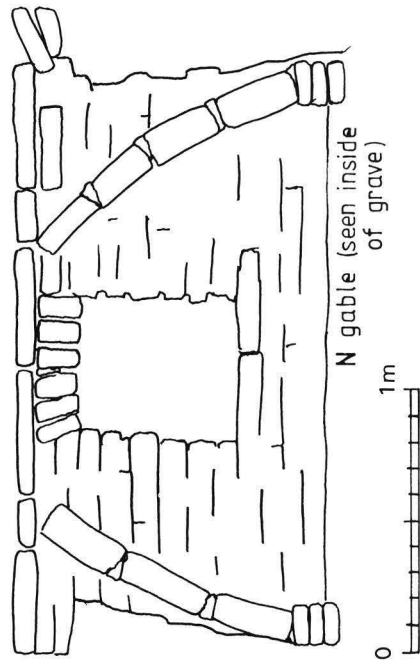
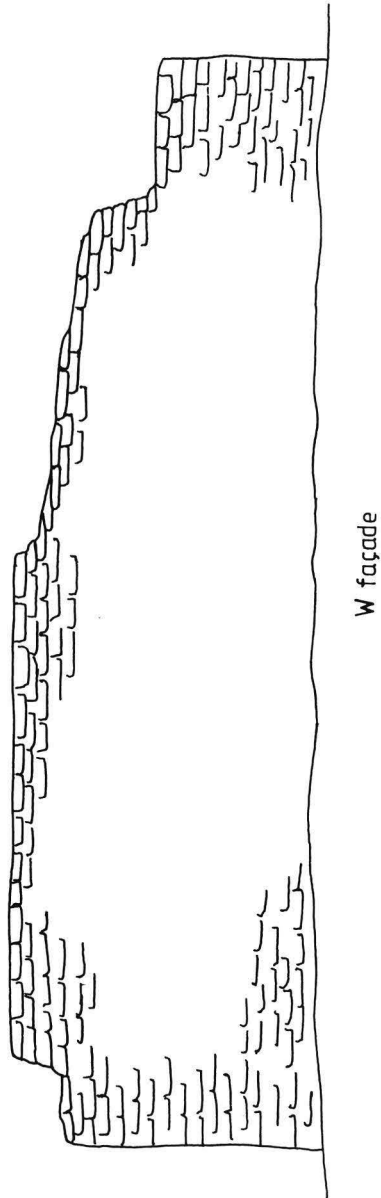
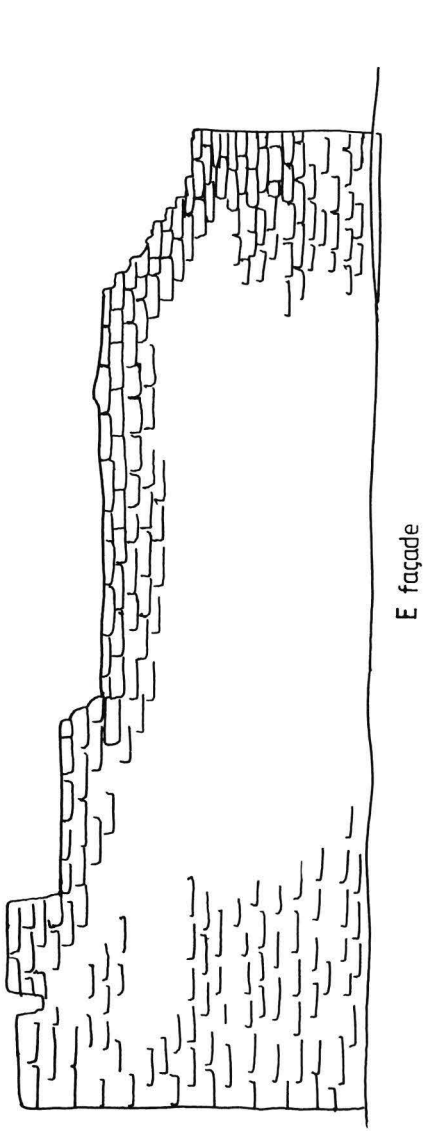
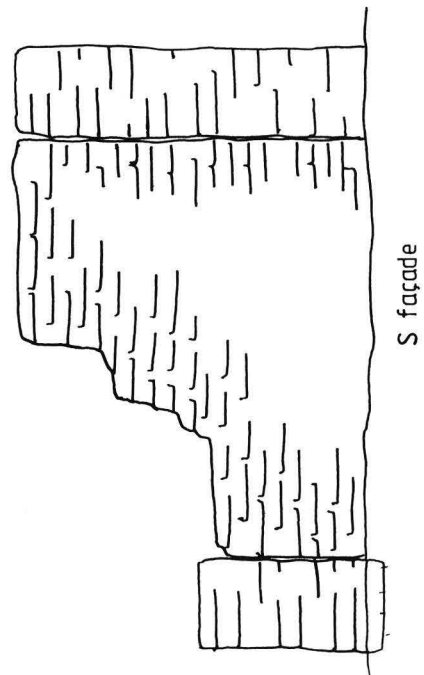

14/3

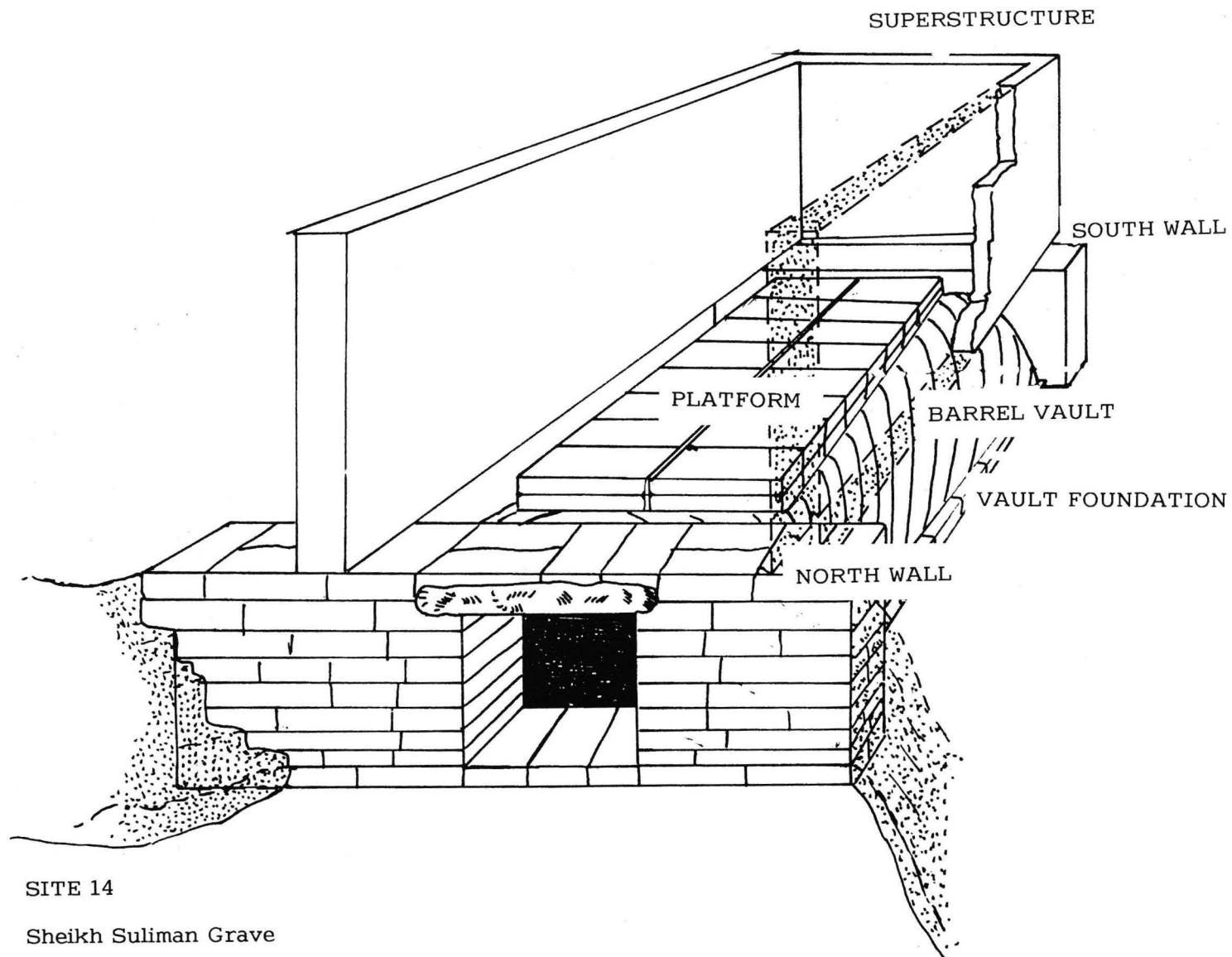

SITE 14

Sheikh Suliman Grave

Hillet Affu
(R. Holthoer -65)

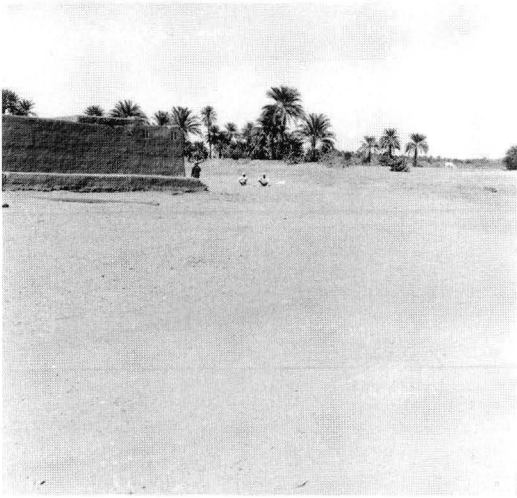

1.

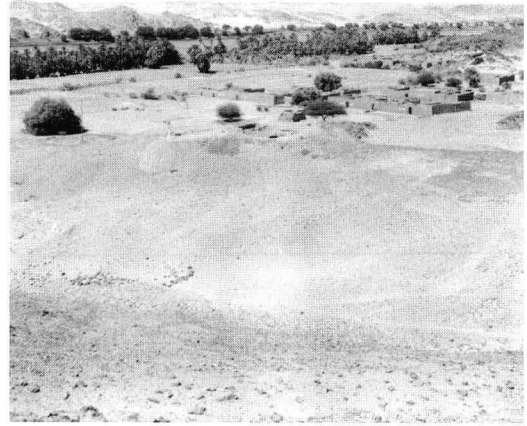

2.

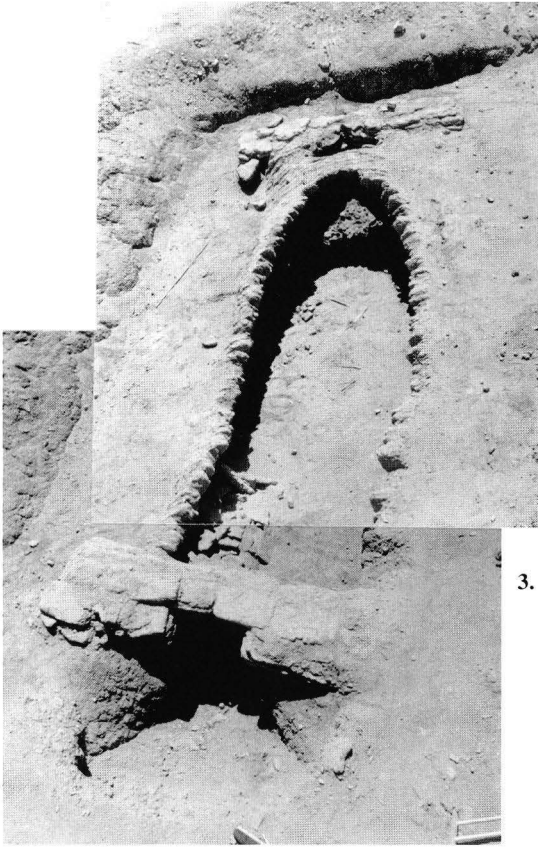

3.



4.

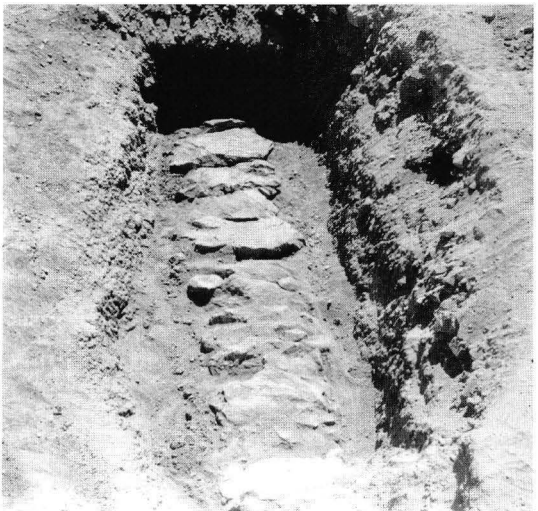

6.

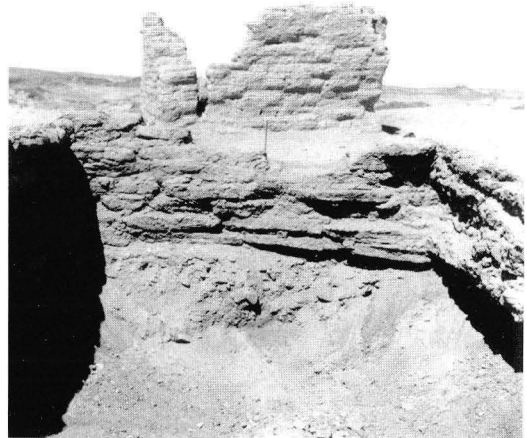

5.

61. 1. Site 12, from SE. 2. Site 14, view from the mountain top in SE. 3. 14/1 from N (excavated by Mills). 4-5. Superstructure, N-wall from inside (14/2). 6. Sealing (14/2).



1.

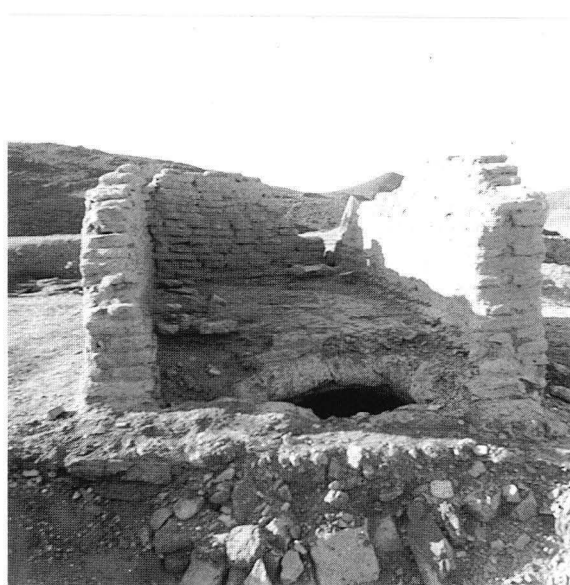

2.



3.



4.



5.



6.

62. 1-2. Superstructure, from N and SE (14/3). 3. Vault under the superstructure, from N (14/3). 4. Bodies in the W-end (14/3). 5. Site 15. New Kingdom part, from N, pit B in the foreground. 6. Burial: a dog and a turtle (15/4).

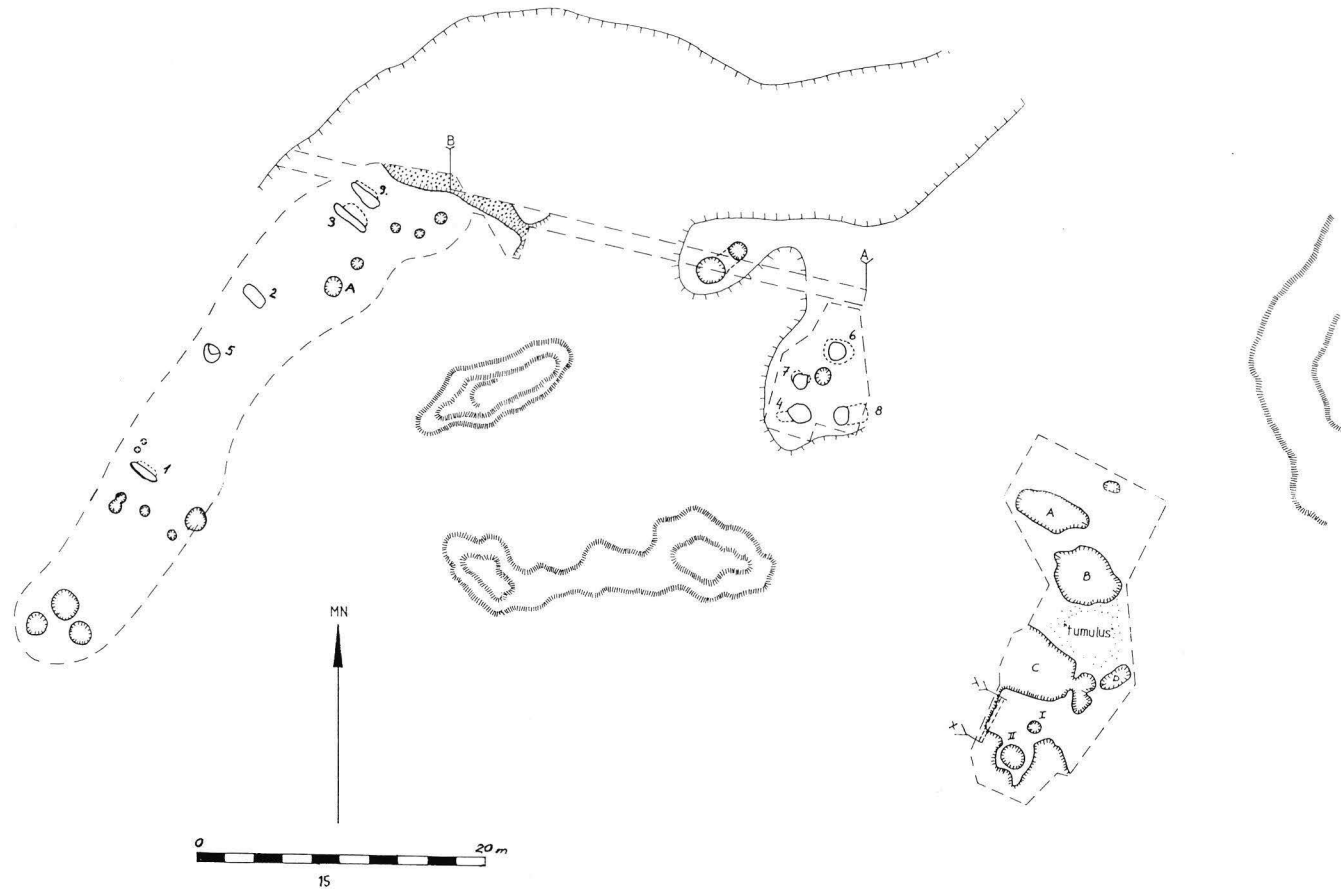

63. Site 15. Plan of the New Kingdom cemetery and habitation site & the Mesolithic habitation site.

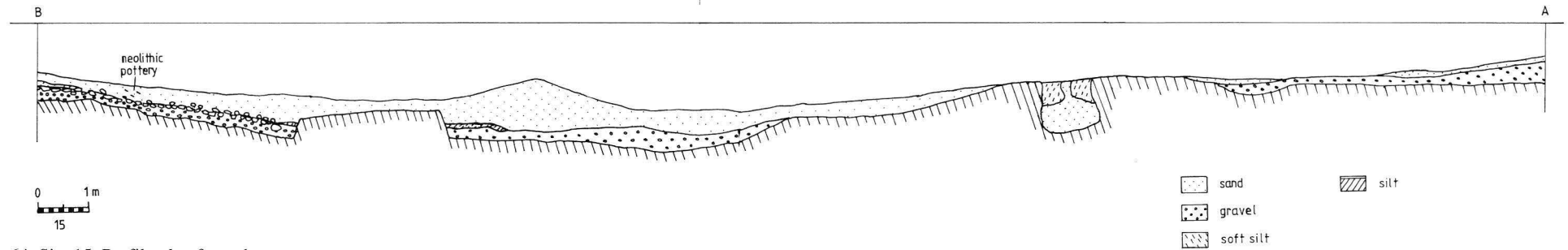

64. Site 15. Profile plan from the cemetery area.

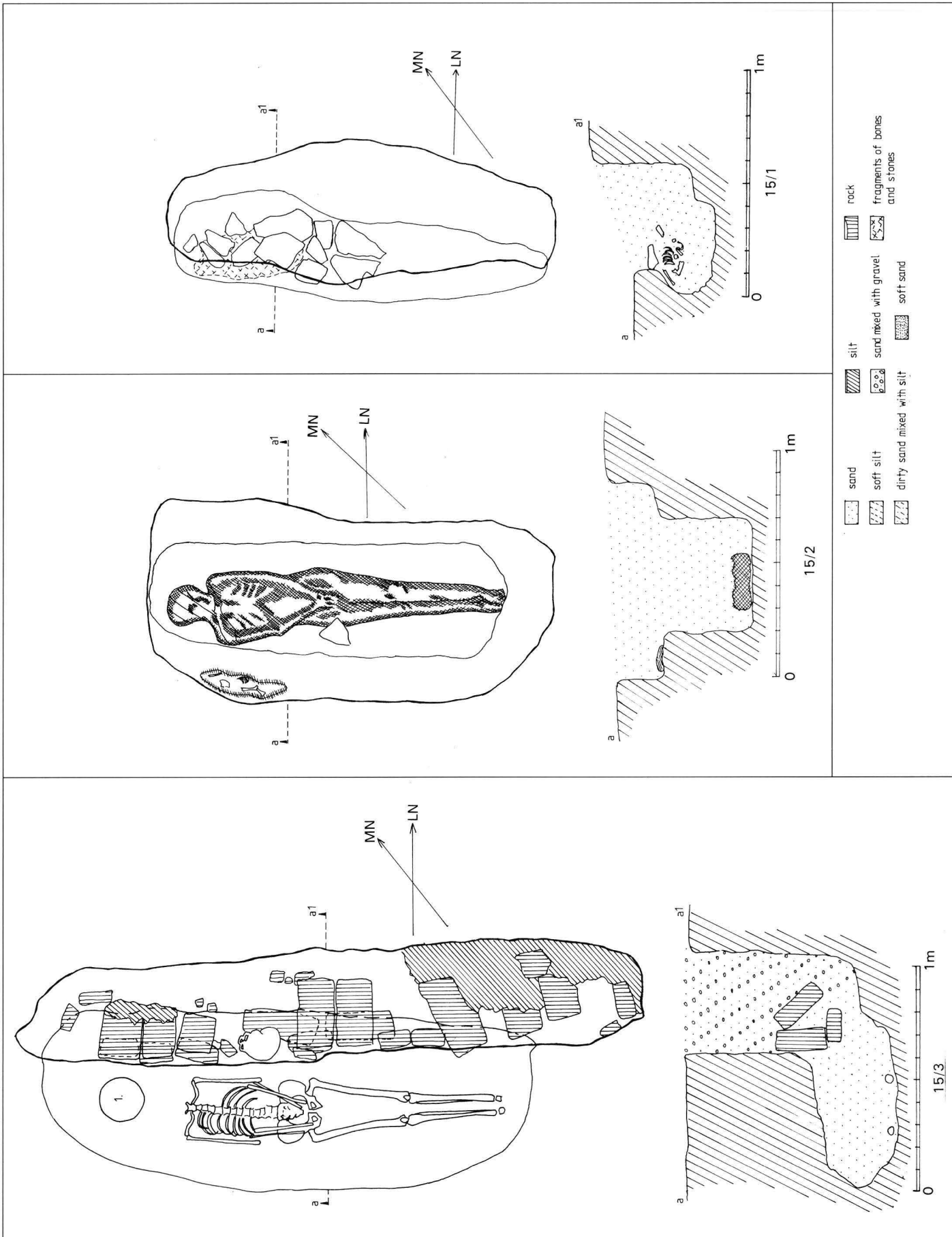

65. Site 15/1-3.

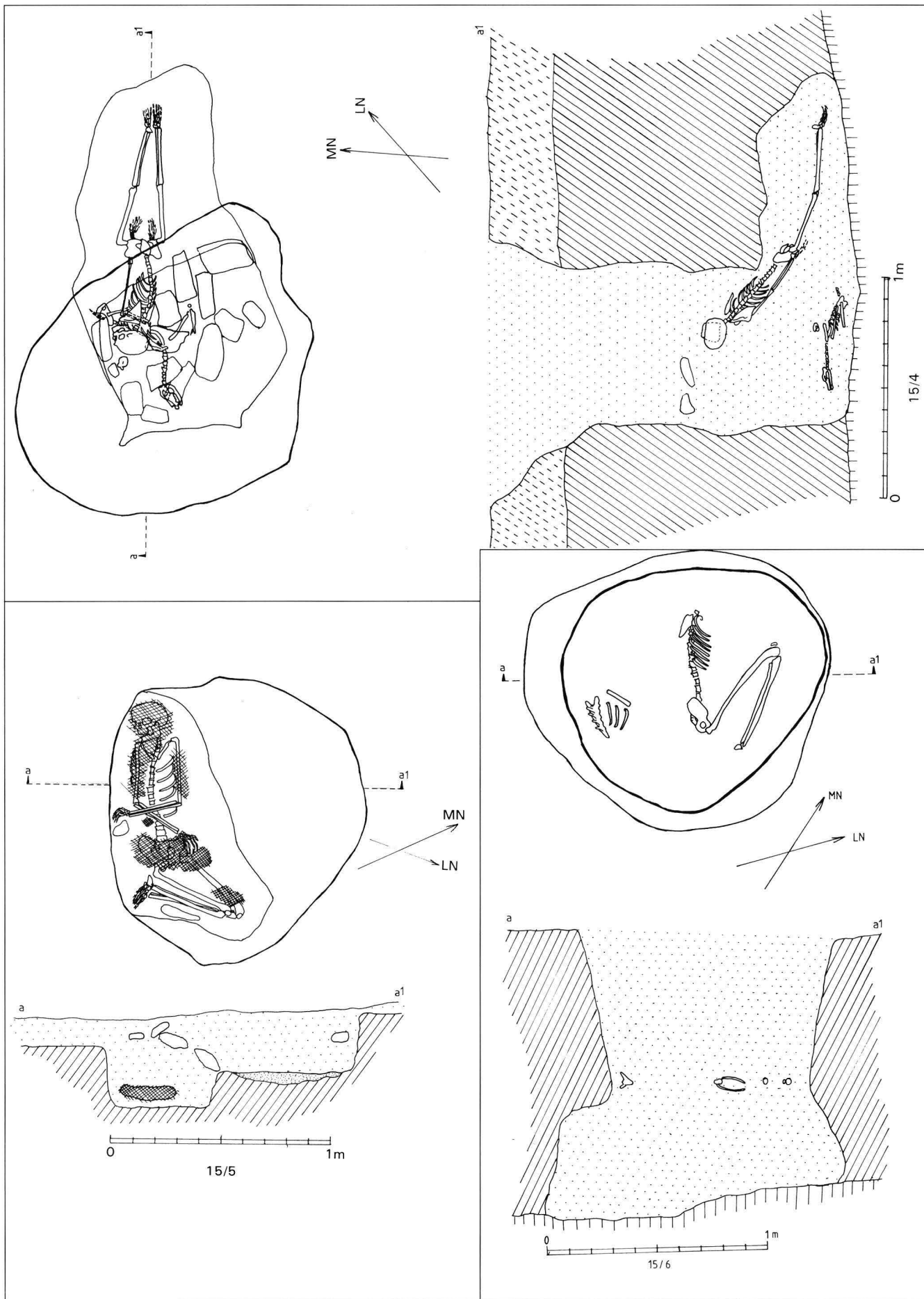

66. Site 15/4-6.

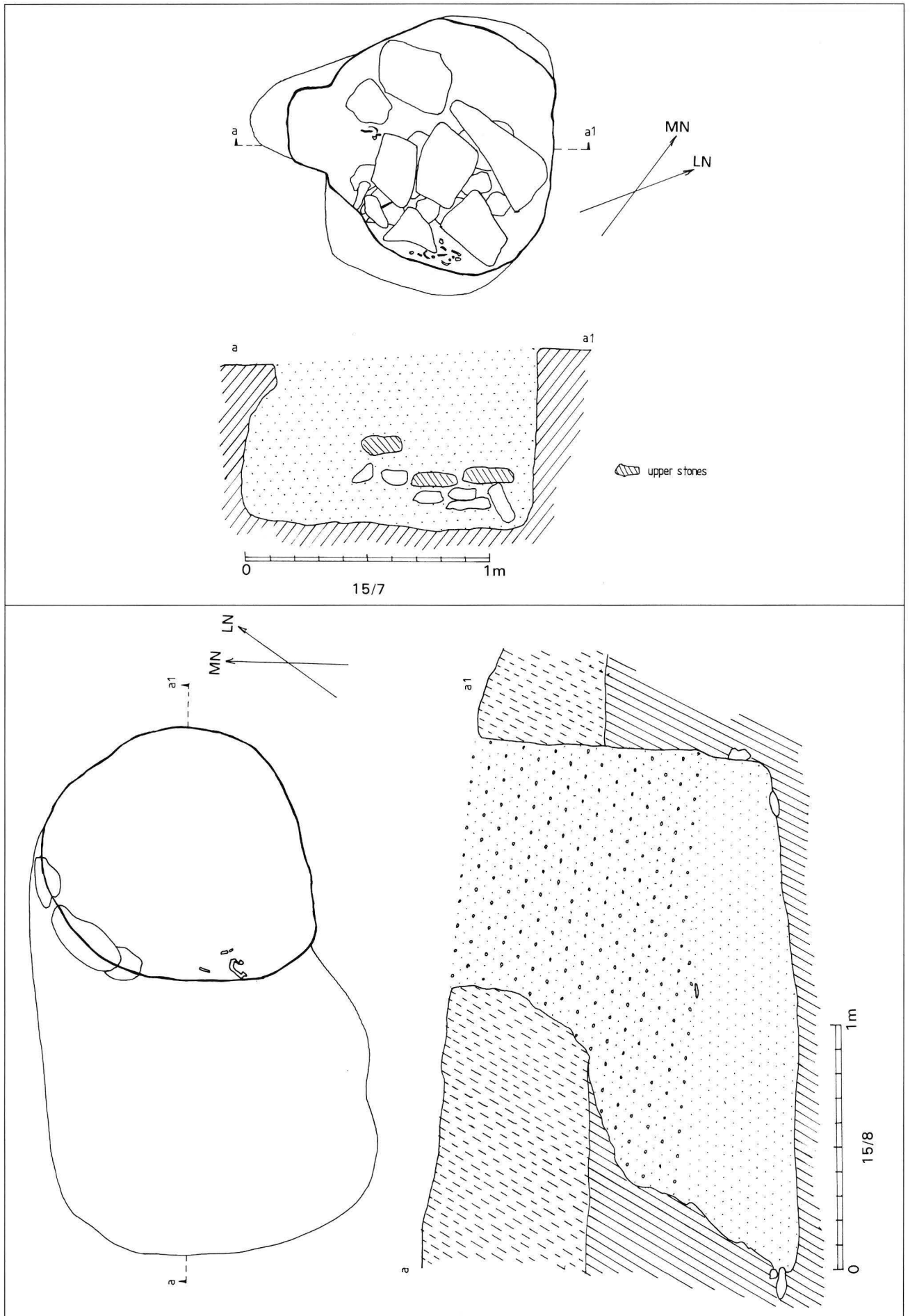

67. Site 15/7,8.

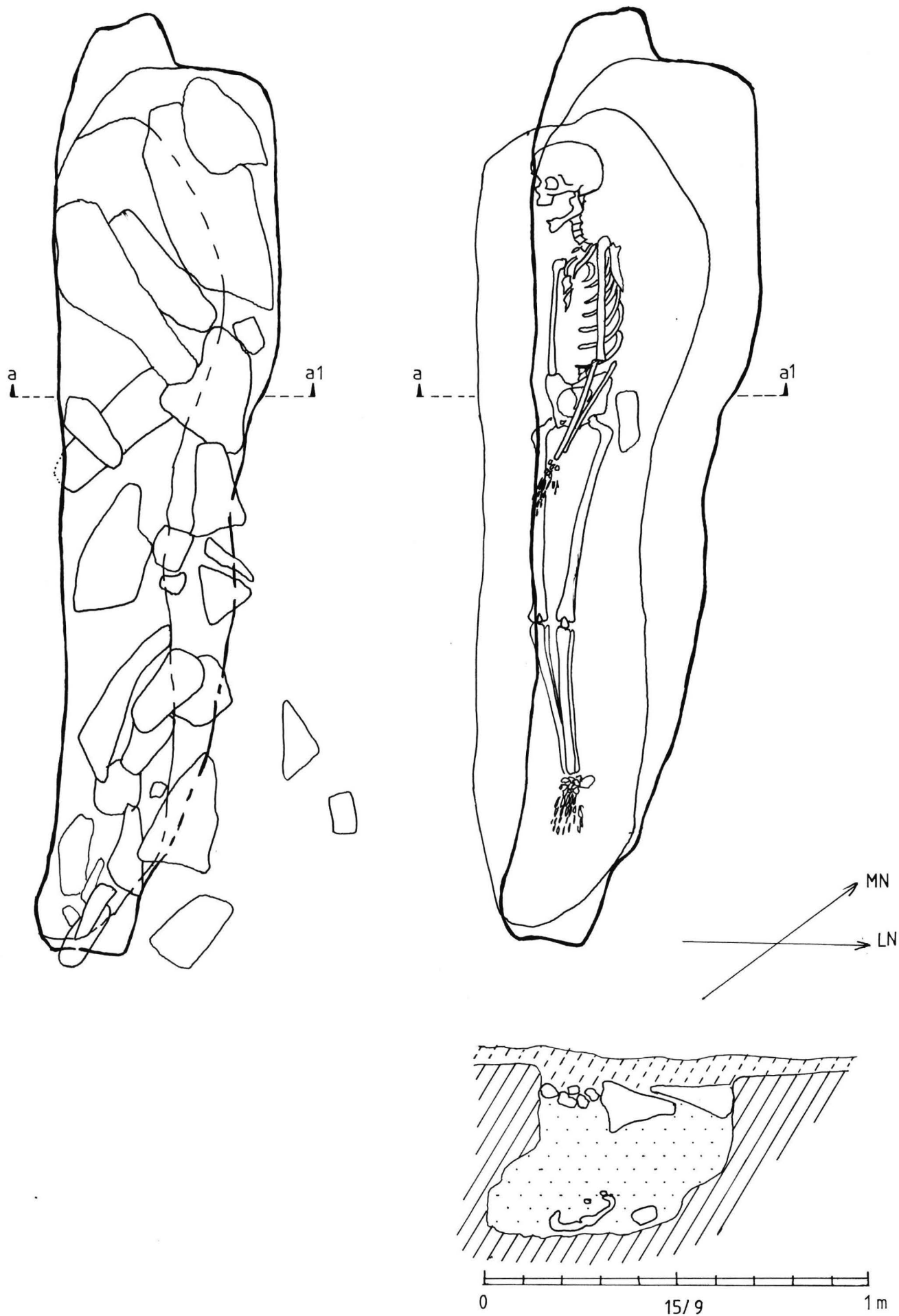

68. Site 15/9.

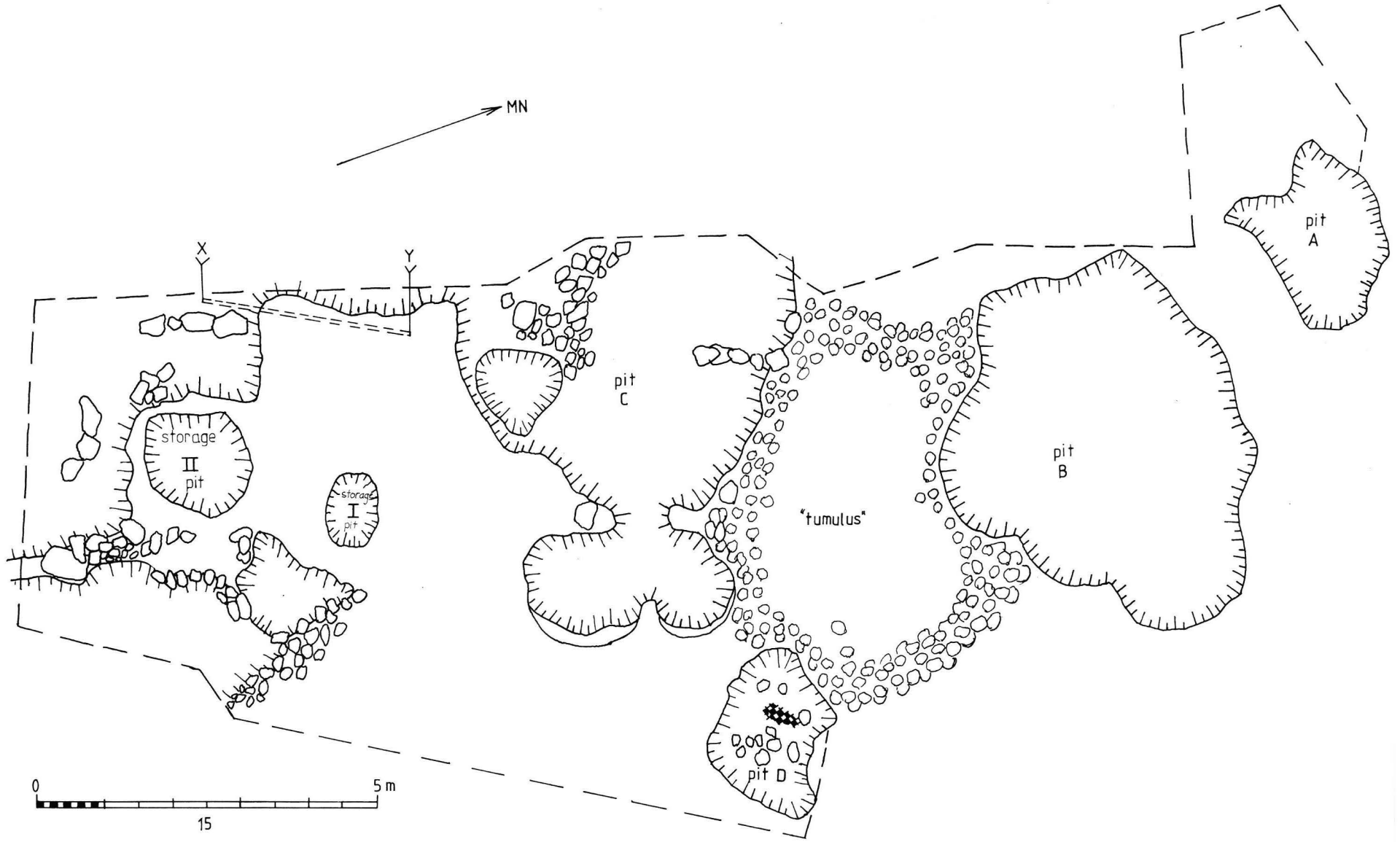

69. Site 15. Plan of the New Kingdom habitation site: pits A–D, I–II & “tumulus”.

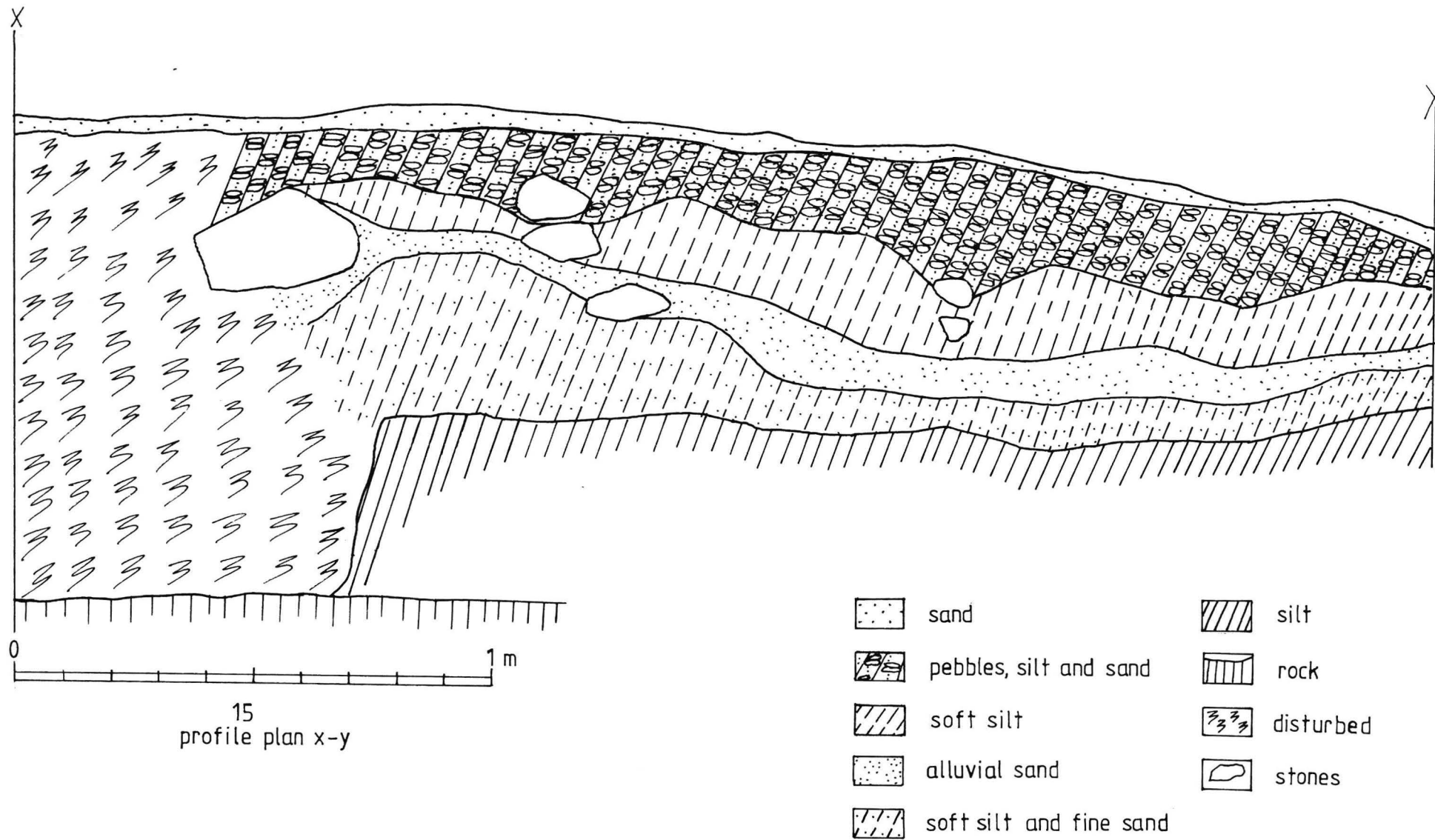

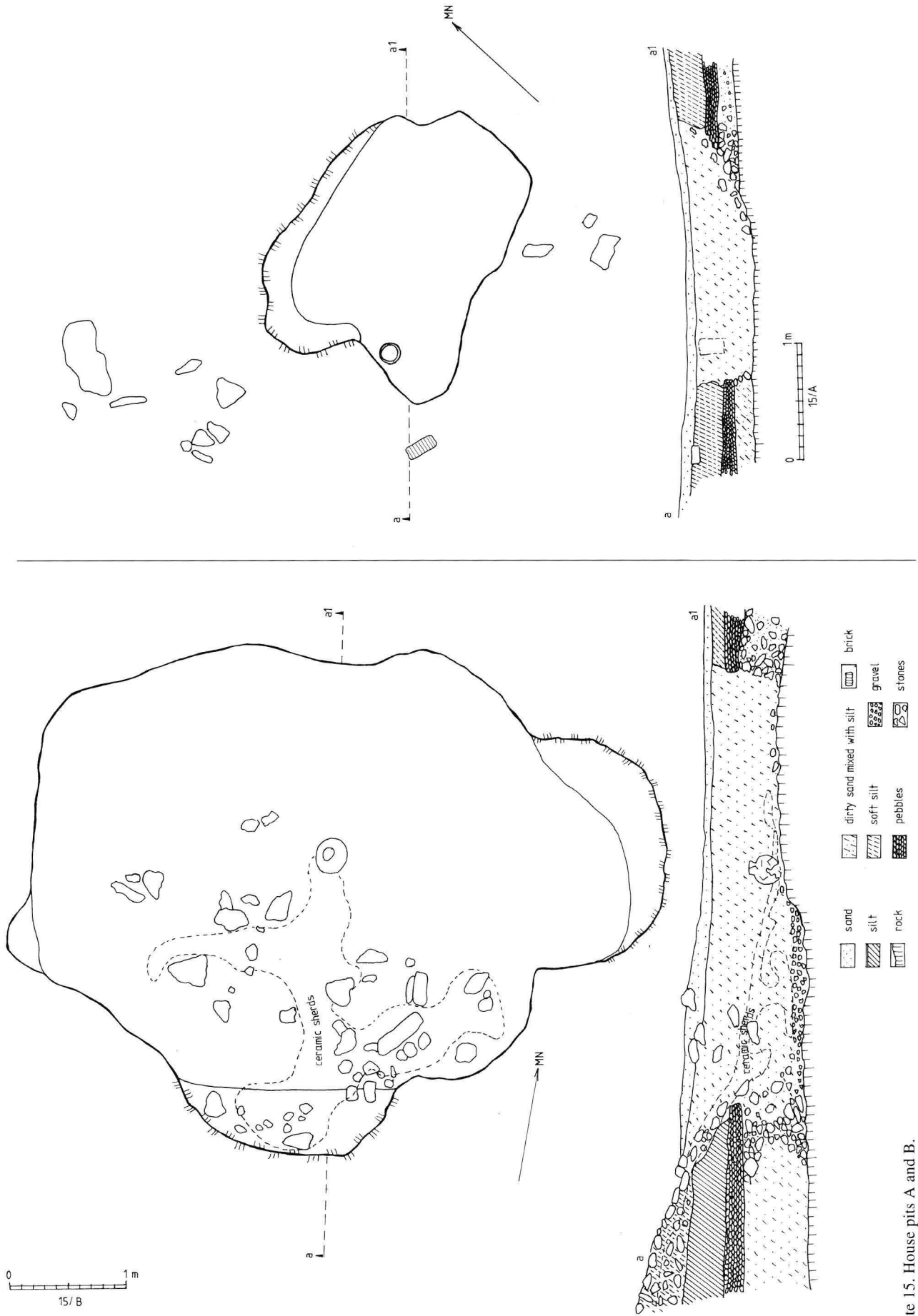

71. Site 15. House pits A and B.

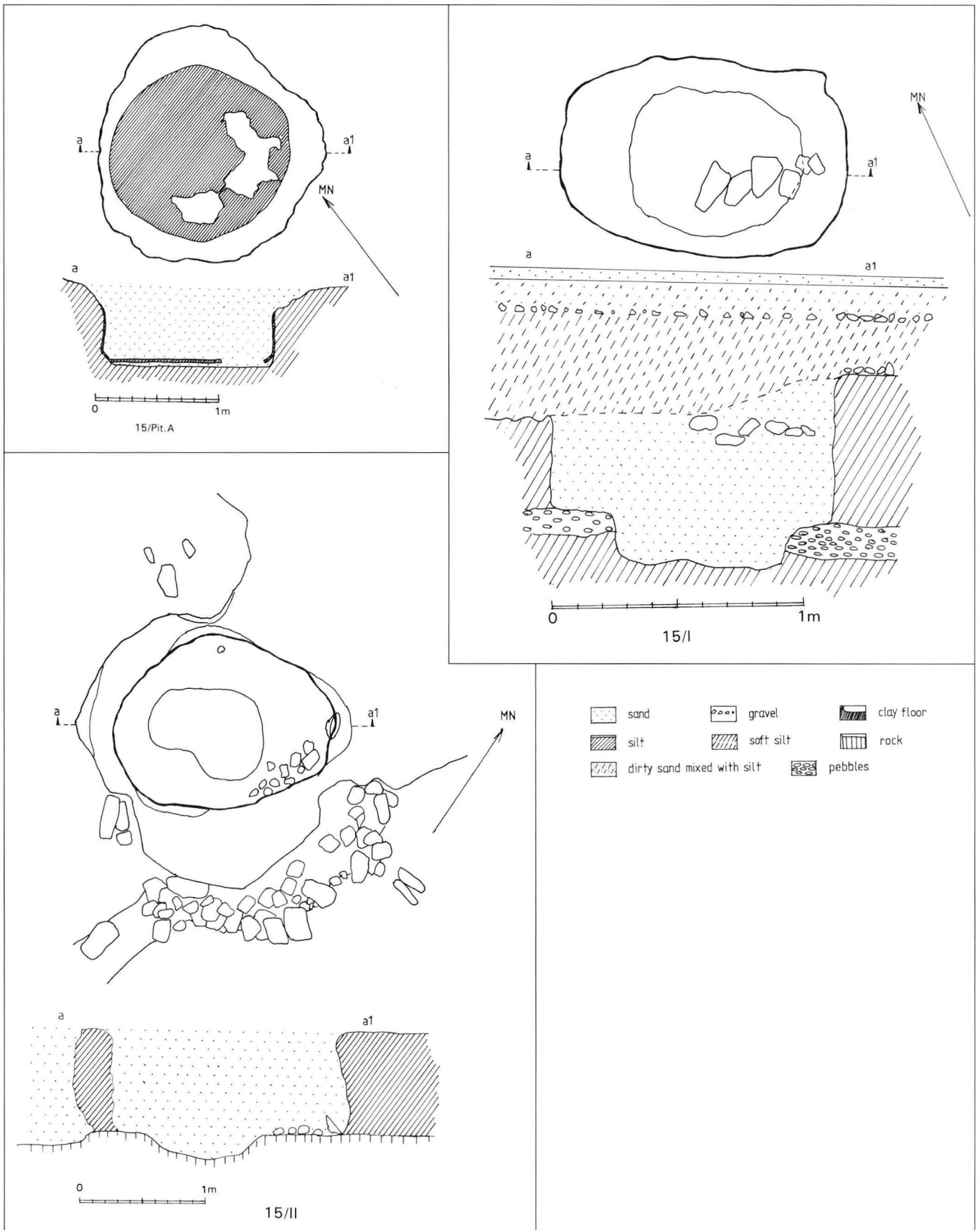

72. Site 15. Pits A, I and II.



1.



2.



3.



4.



5.



6.

73. 1-2. Superstructure and a body in the shaft (15/5). 3. Body in the shaft (15/6). 4. A 'creek', E of 15/9. 5. "Pottery heap". 6. Pit C, detail of the wall, from SE.



1.



2.

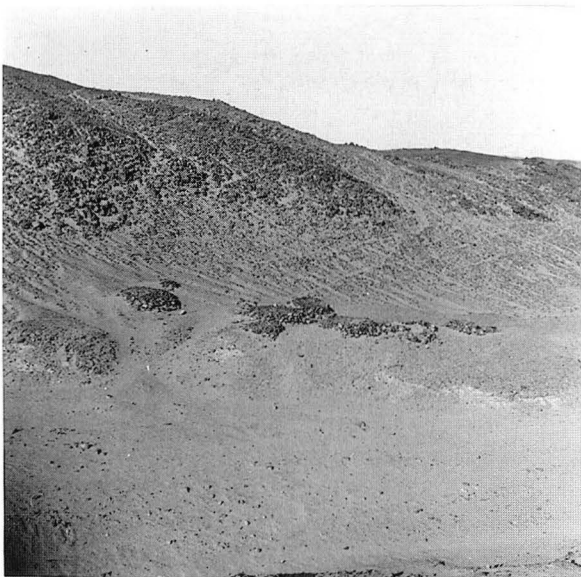

3.



4.



5.



6.

74. 1. Site 15, tumulus, excavated, from N. 2. 150m SE of the site 15, pottery in situ. 3. Site 17, the W-part. 4-6. Superstructure, a sealing before opening and a body in the shaft (17/2).

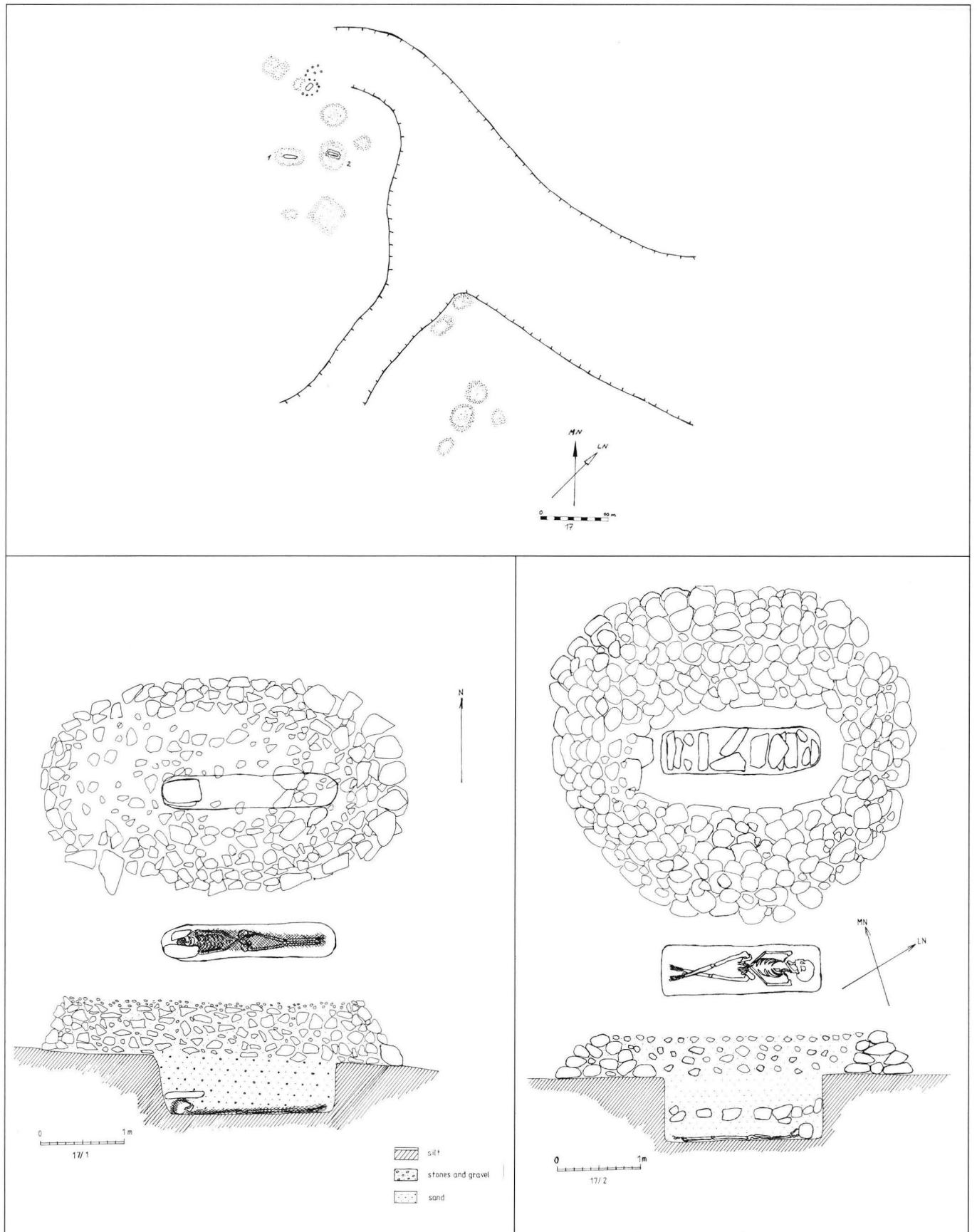

75. Site 17/1,2. Plan.

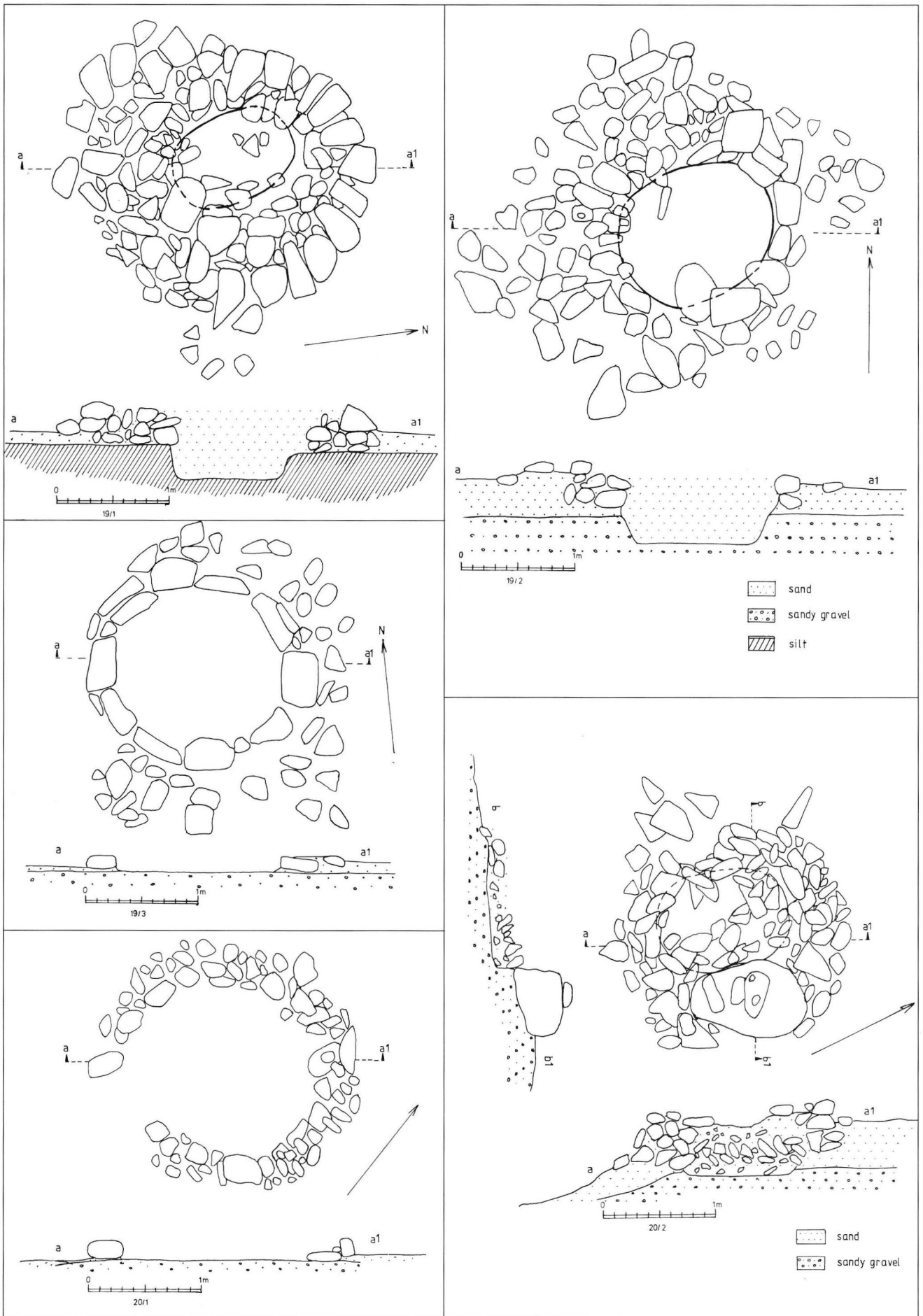

76. Sites 19/1-3 and 20/1-2. Plan.



1.



2.



3.



4.



5.



6.

77. 1-2. 19 and 19/1. 3-4. 20/1 after the excavation and 20/2 before the excavation. 5-6. Site 21 from N and the house 21/12.

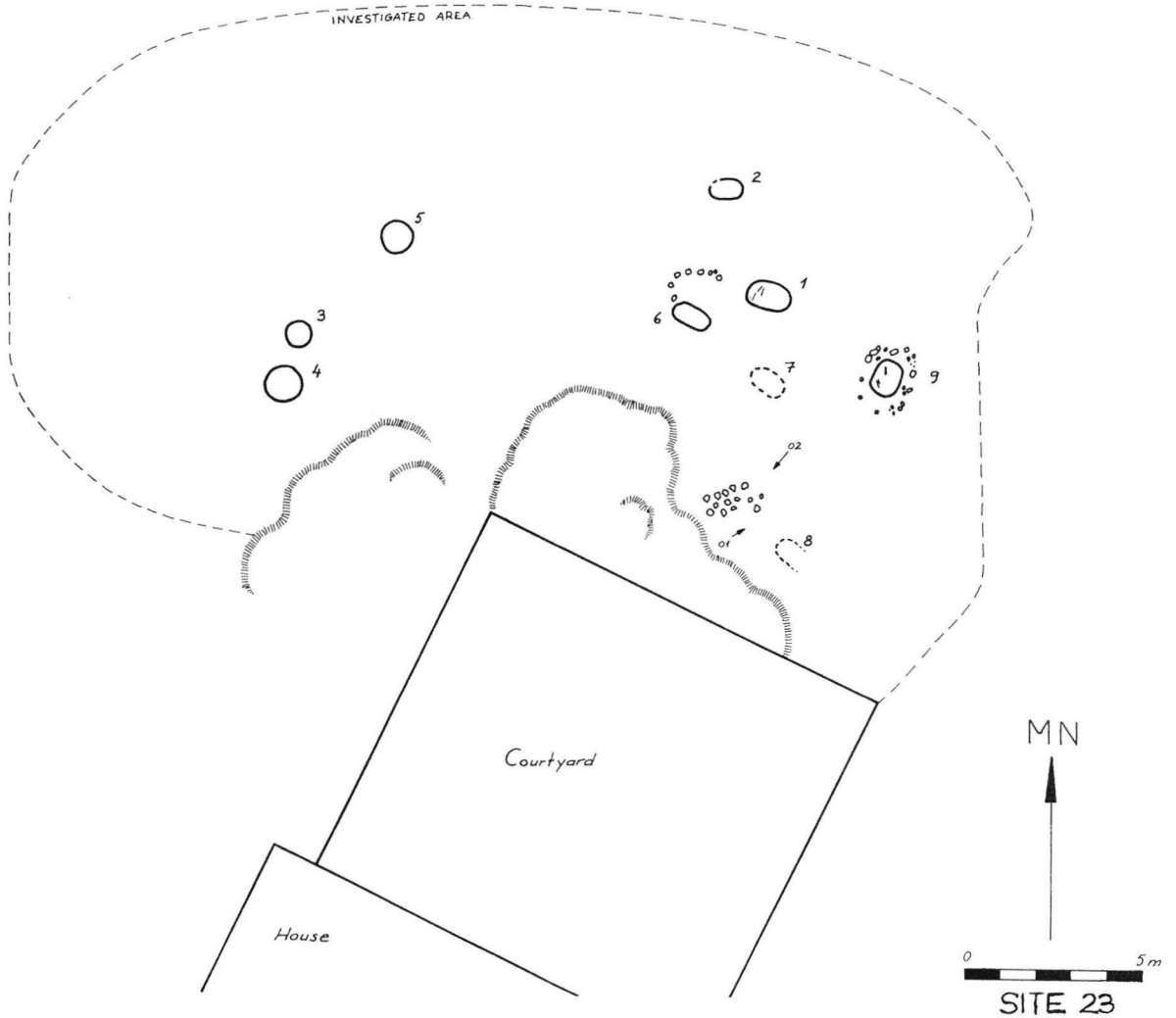
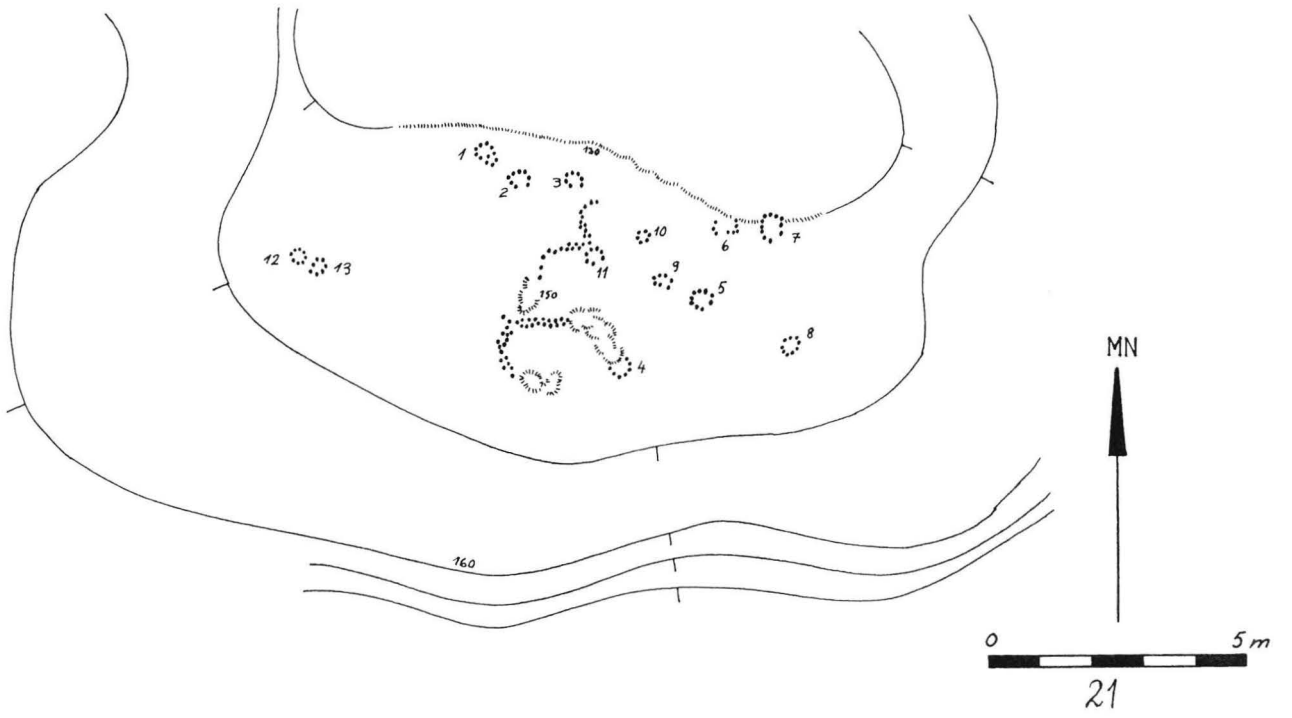

78. Site 21 and site 23. Plan.

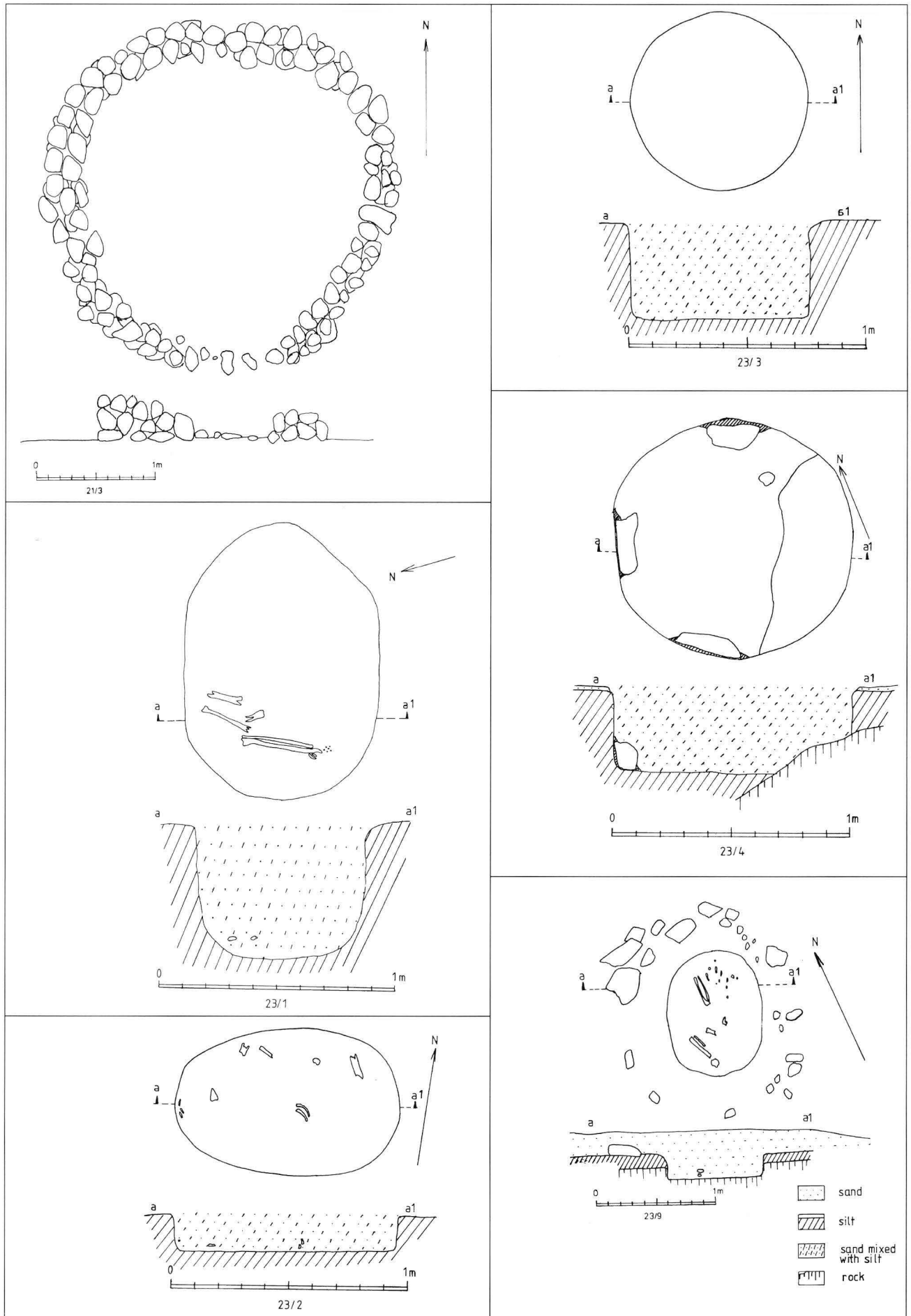

79. Sites 21:3 and 23:1-4,9.



1.



2.

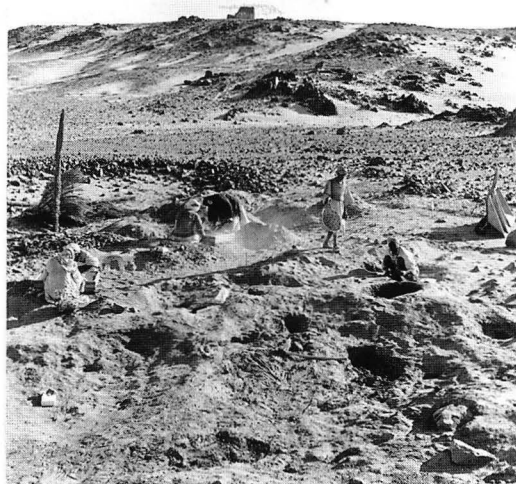

3.

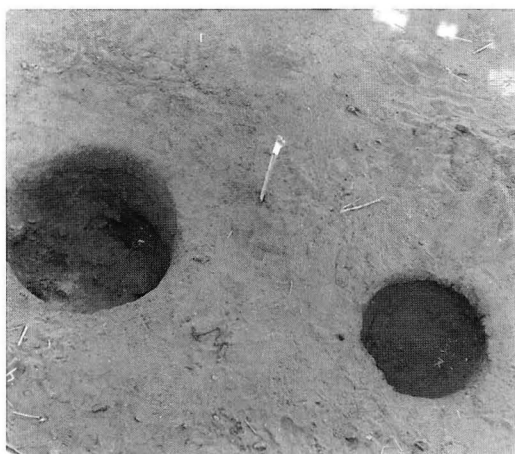

4.

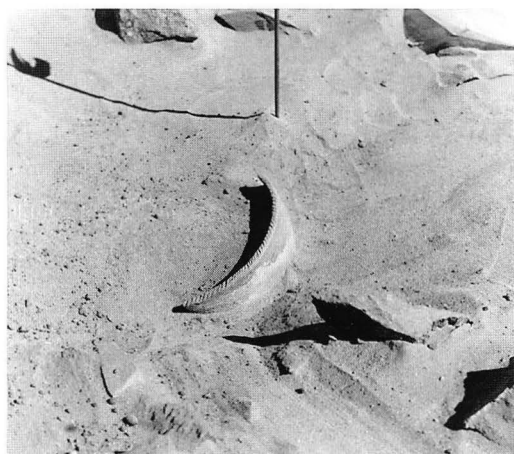

5.

80. 1. Site 24, from S. 2. Site 24, superstructure. 3. Site 23 under the excavation, from W. 4. 23/3,4 emptied from SE. 5. 23/01 in situ.

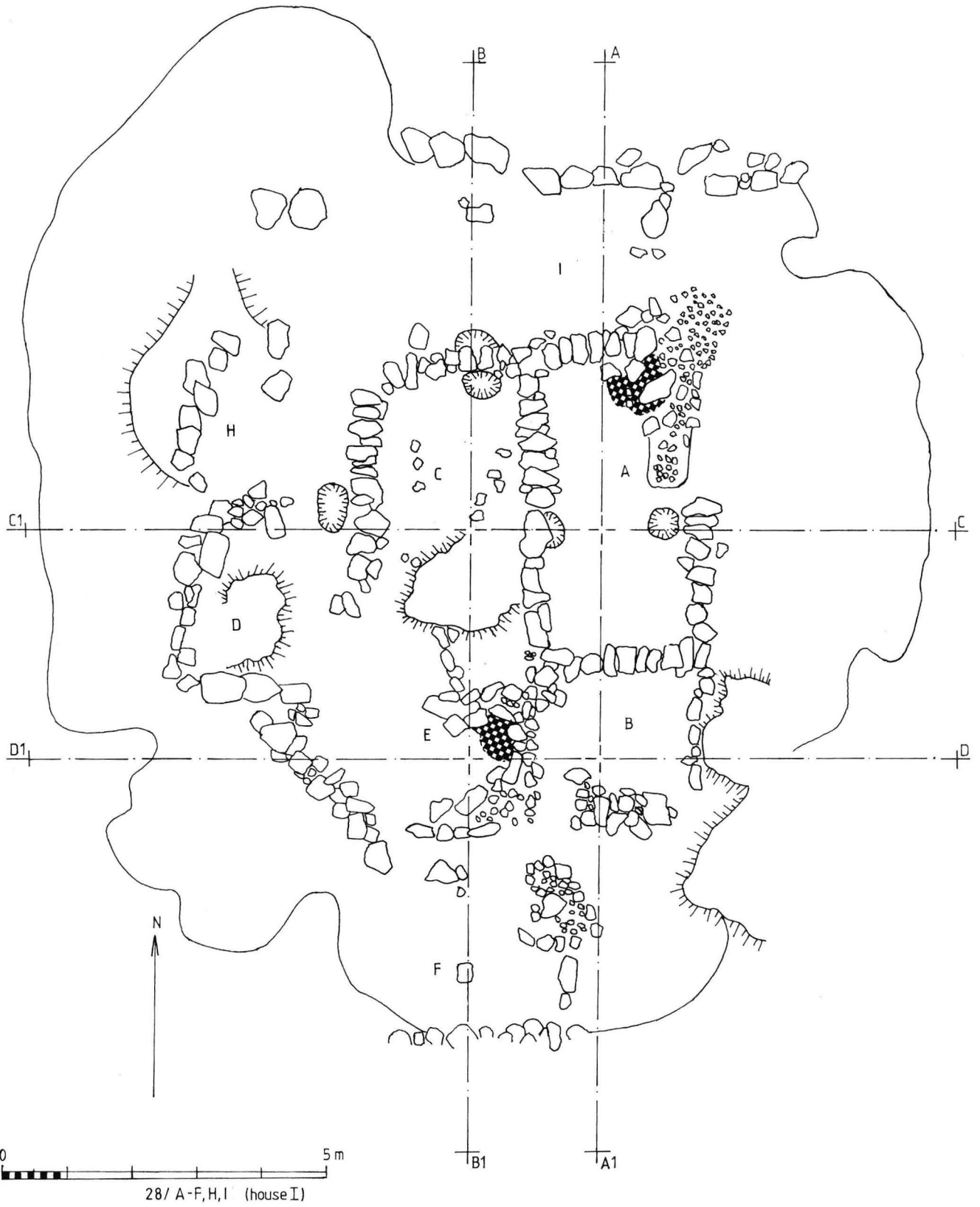

81. Site 28. General plan.

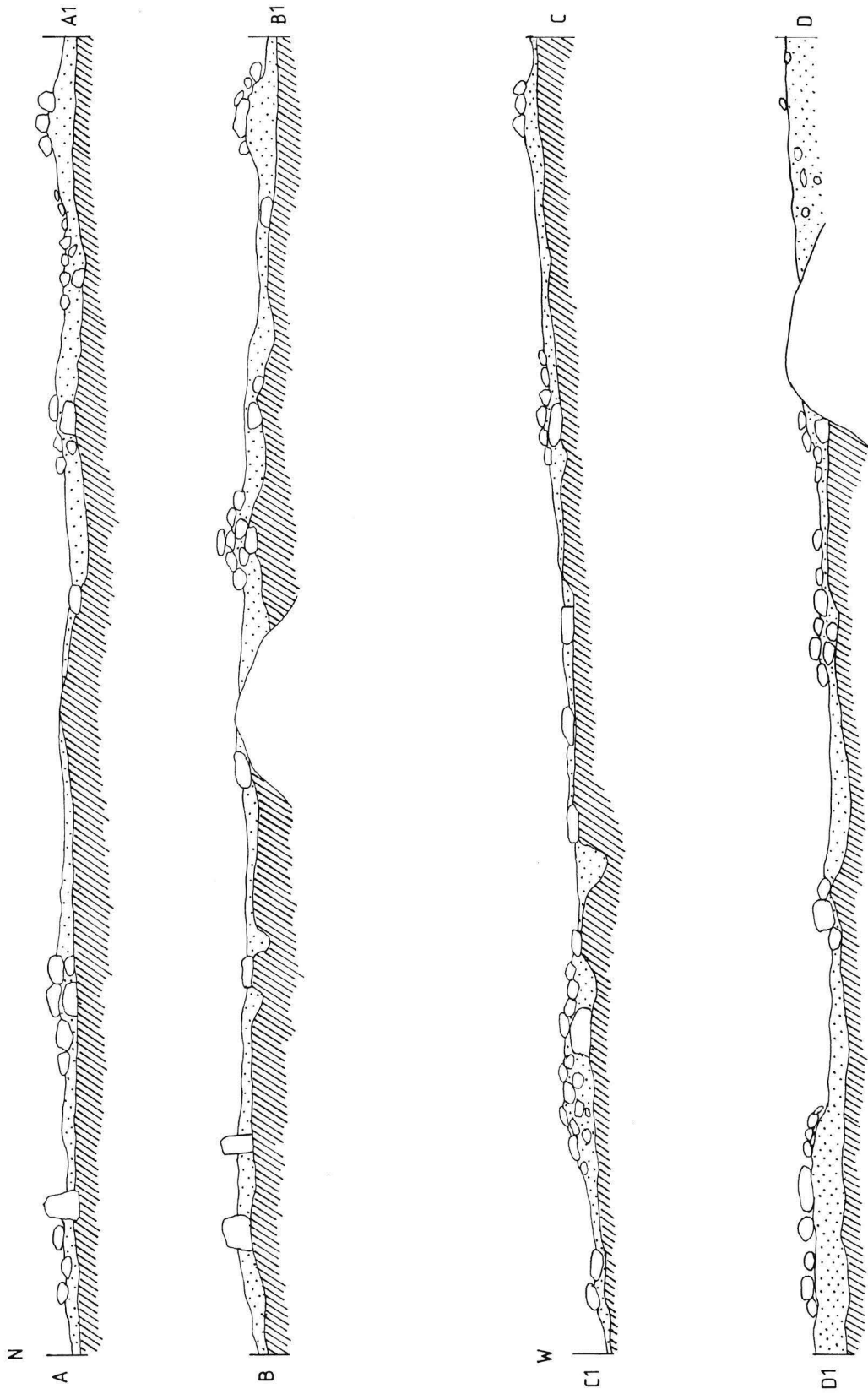

82. Site 28. Profile plan A-D.

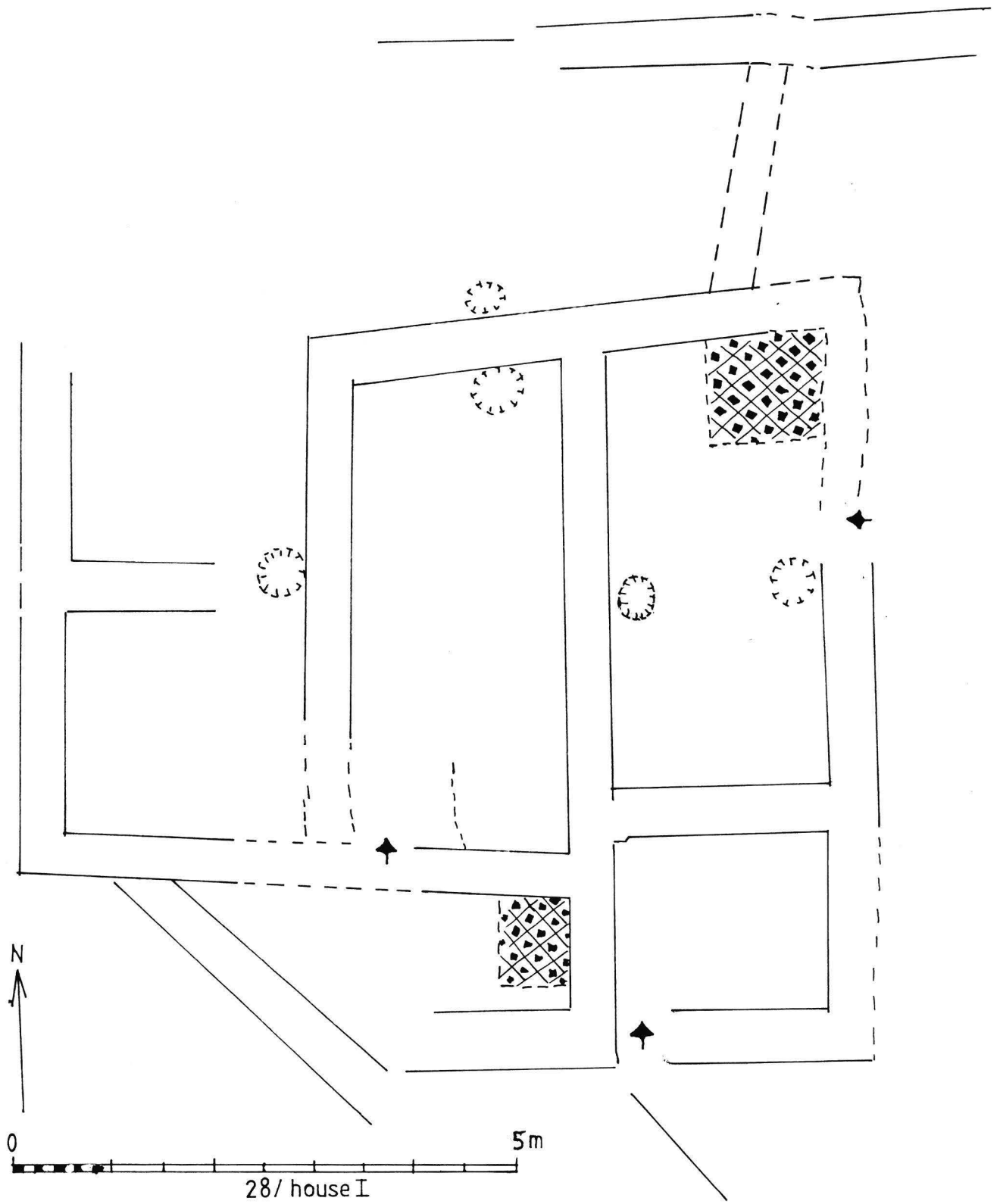

83. Site 28. Plan of the house I.

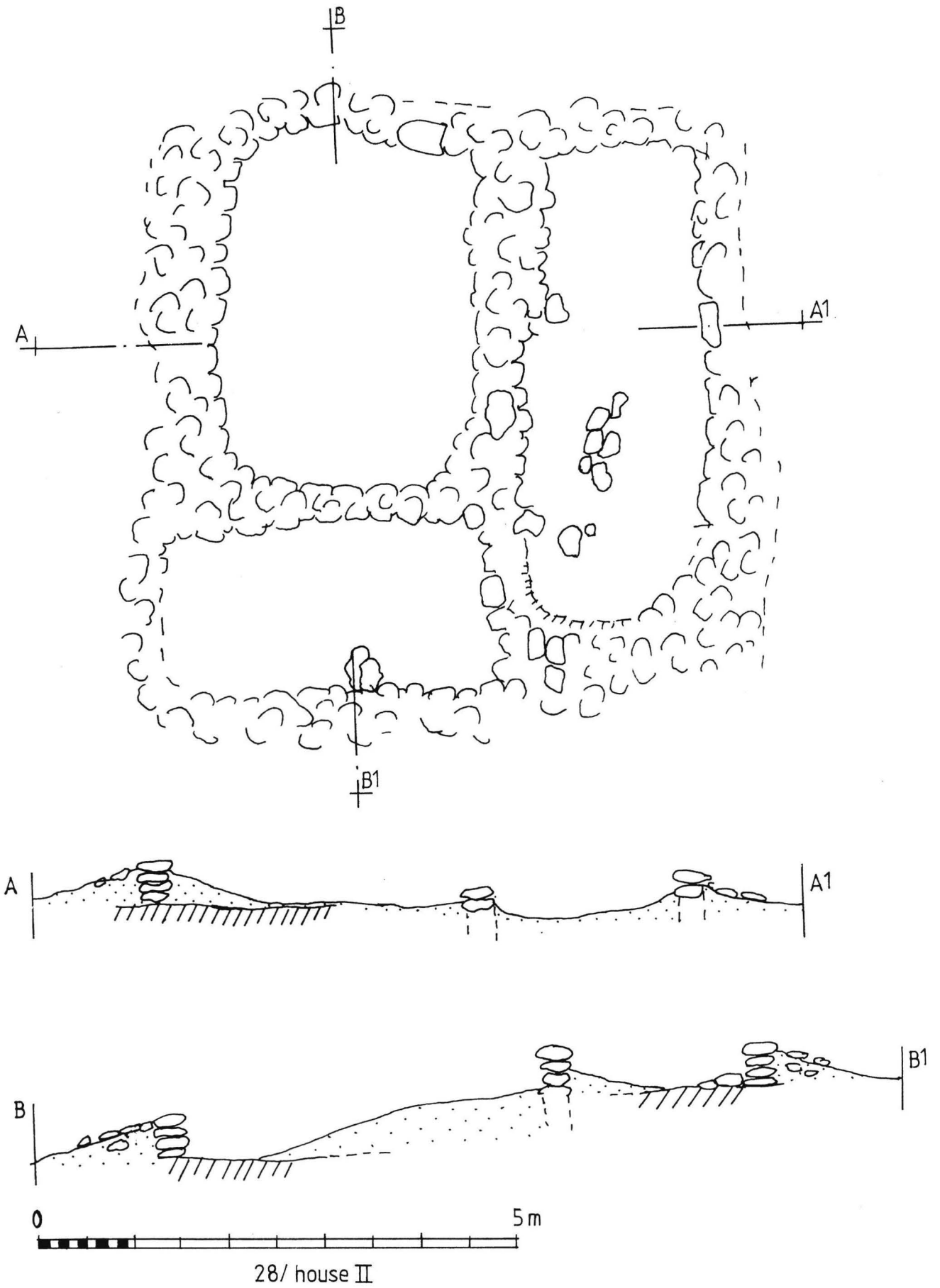

84. Site 28. Profile plan of the house II.

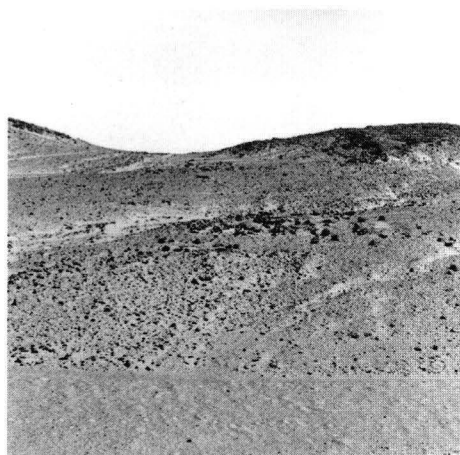

1.



2.



3.



4.

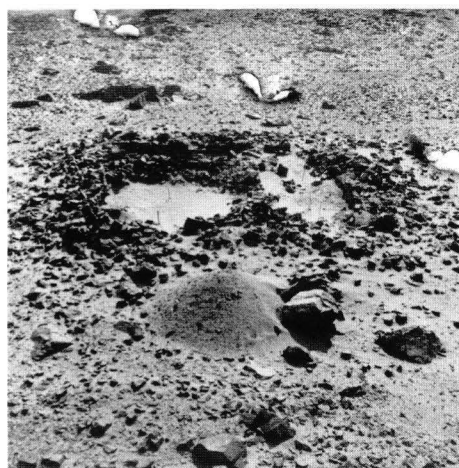

5.



6.

85. 1. Site 27, from WSW. 2. Site 28, from SE. 3. House 28/2, rooms A&B, from SSW. 4. 28/2, hearth in room A, from W. 5. 28/1, from NW. 6. 28/1, N-wall from inside.

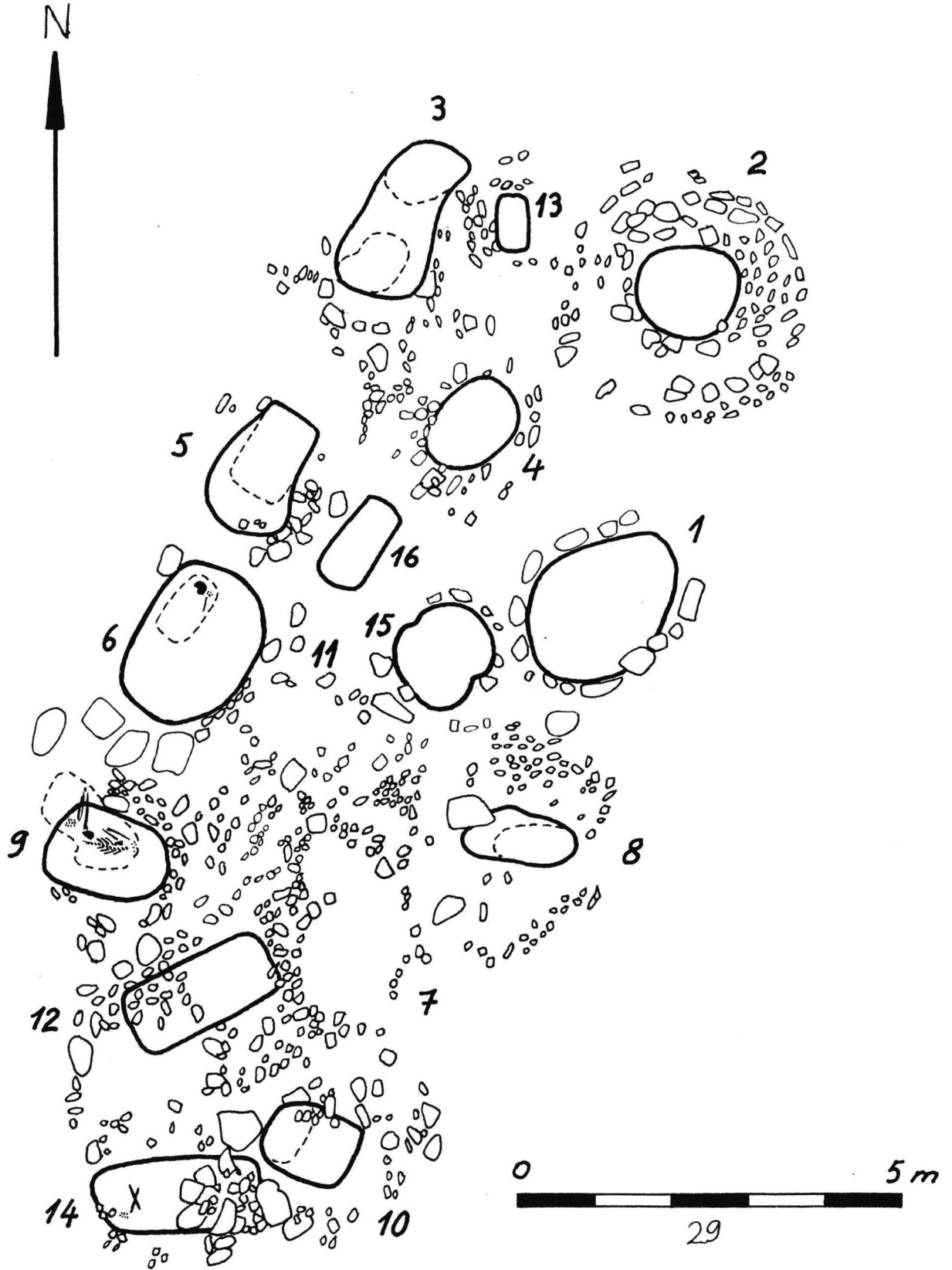

86. Site 29. Plan.

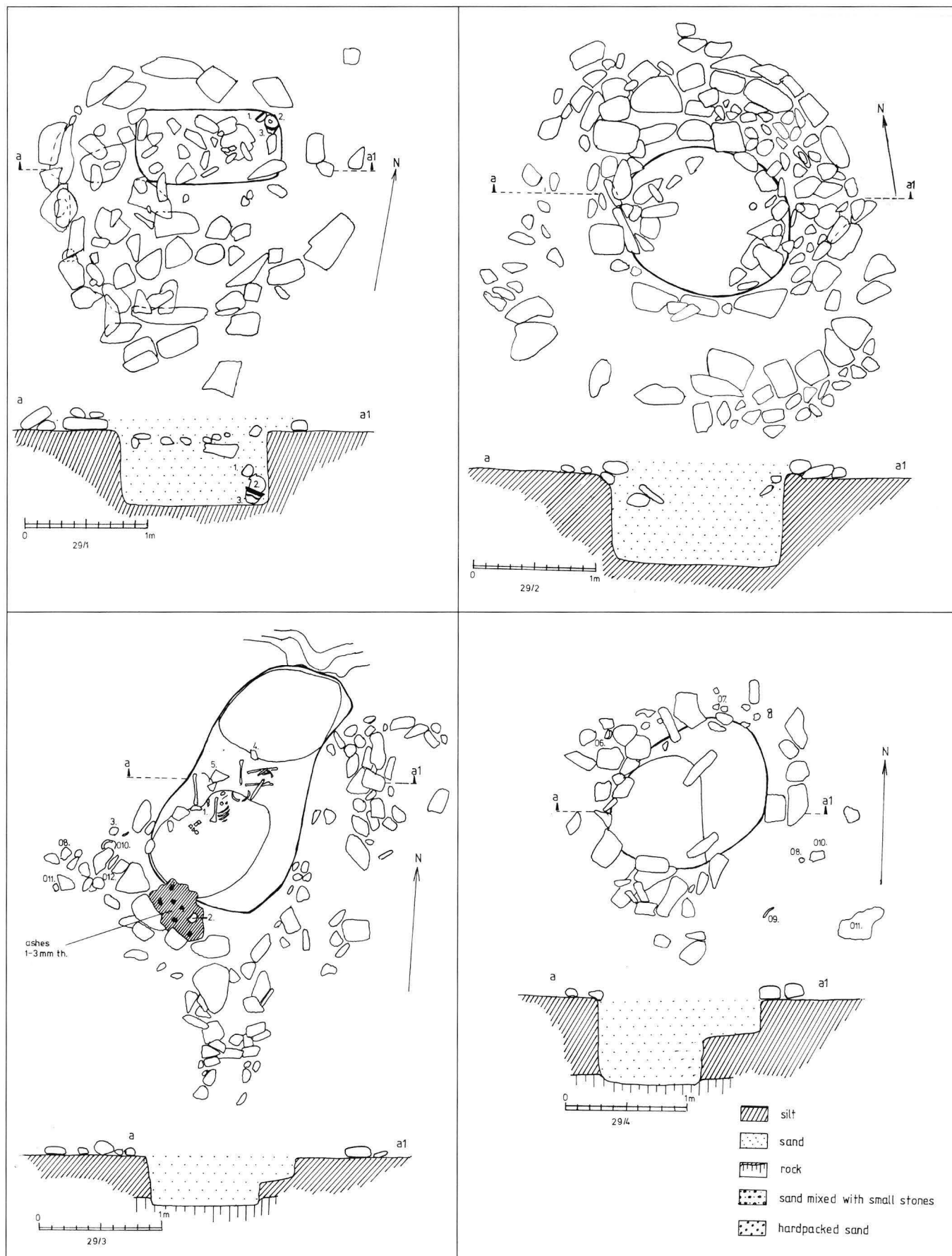

87. Site 29/1-4.



88. Site 29/10,12,14. Plan.

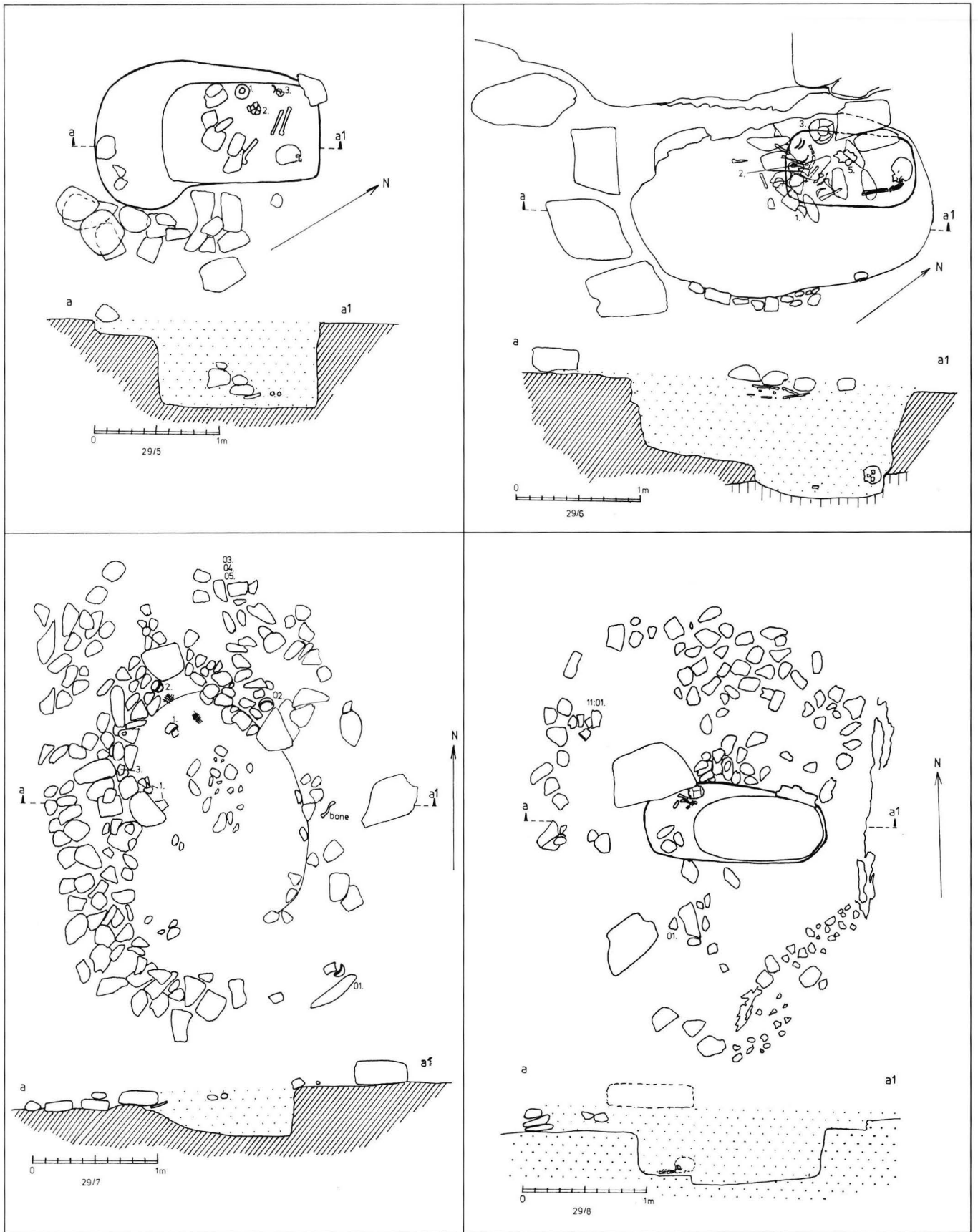

89. Site 29/5-8.

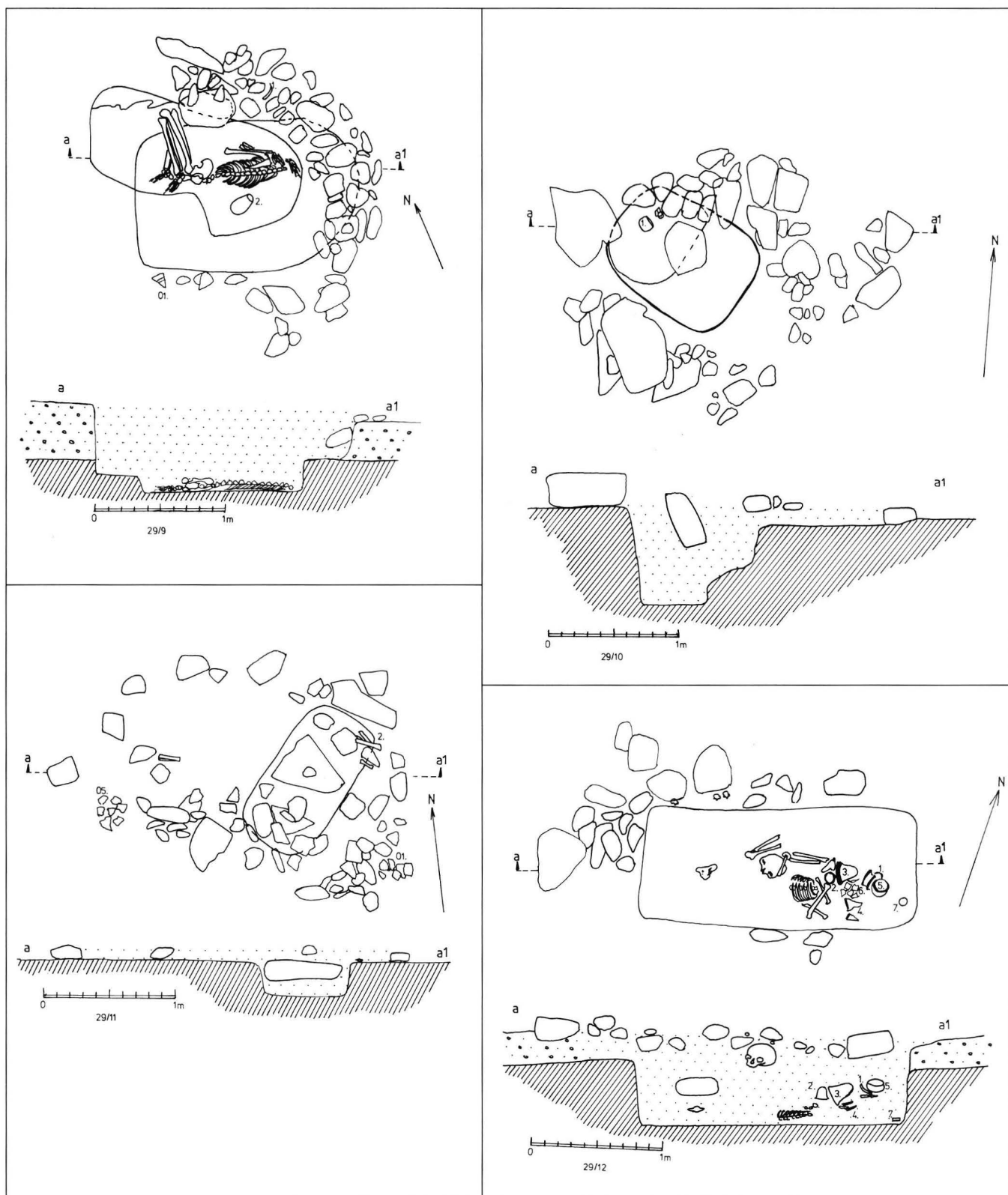

90. Site 29/9-12.

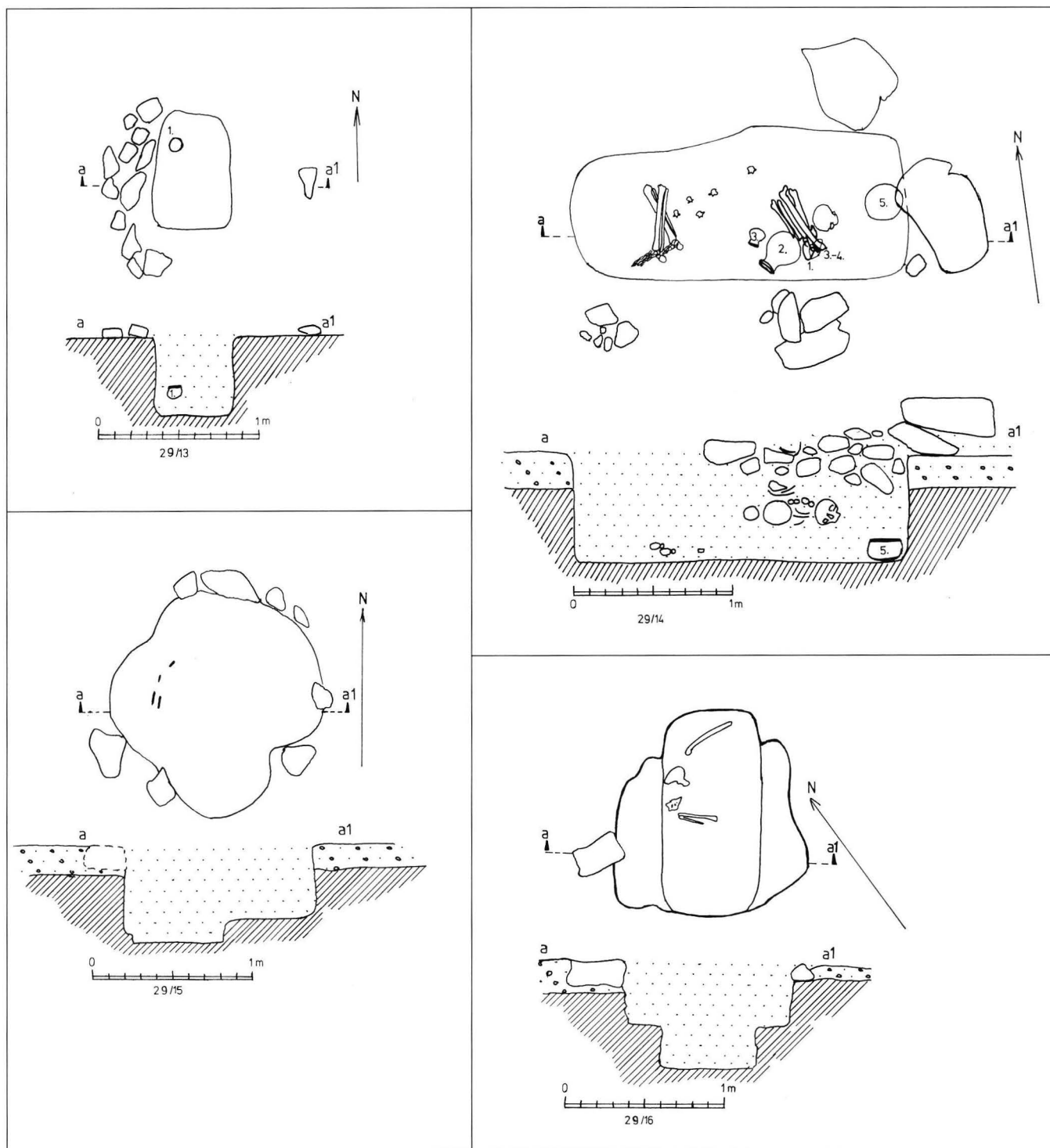

91. Site 29/13-16.



1.



2.



3.



4.



5.

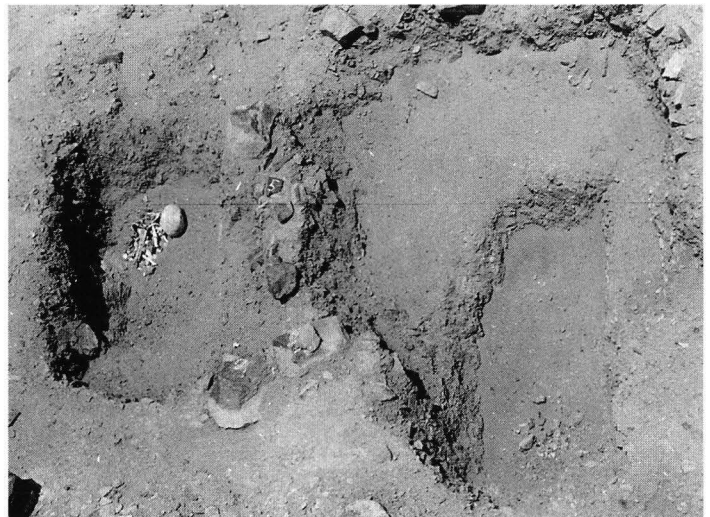

6.

92. 1. Site 29, aerial view. 2. Sealing (29/1). 3. Emptied, from E. 4. Emptied, from S (29/3,4). 5. 29/3:2 in situ. 6. 29/5&16, excavated.



1.



2.



3.

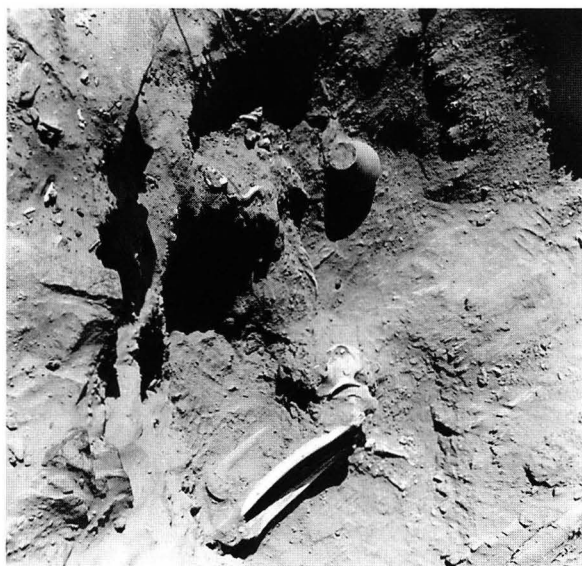

4.

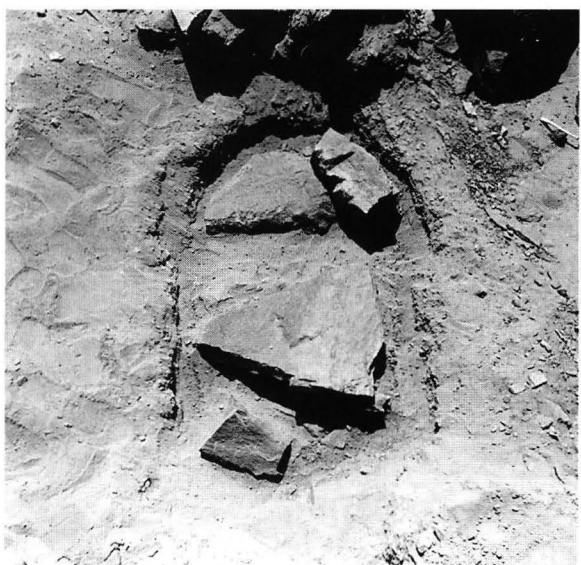

5.



6.

93. 1. 29/5:1,2 in situ. 2-4. 29/9 before excavation, from NW, sealing and a body in the shaft. 5. Sealing, from NE (29/11). 6. The "wall" possible made by robbers plundering grave 6, sherds embedded in the "wall".

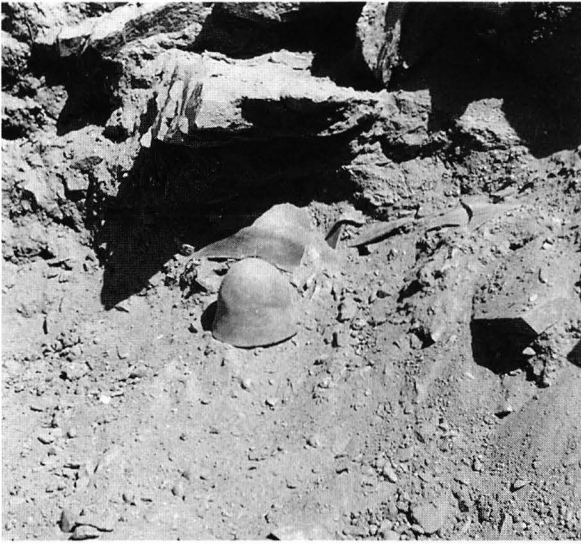

1.



2.



3.

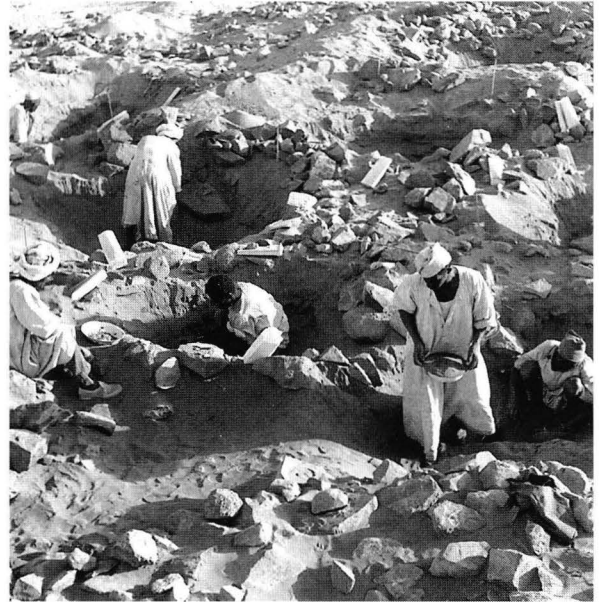

4.



5.



6.

94. 1. 29/12:2,3 in situ. 2. Bones and pottery in situ (29/14:2,3). 3. Site 30, from E. 4. Site 30, under excavation. 5. Before excavation, from S (30/1). 6. 30/2:1-3 in situ.

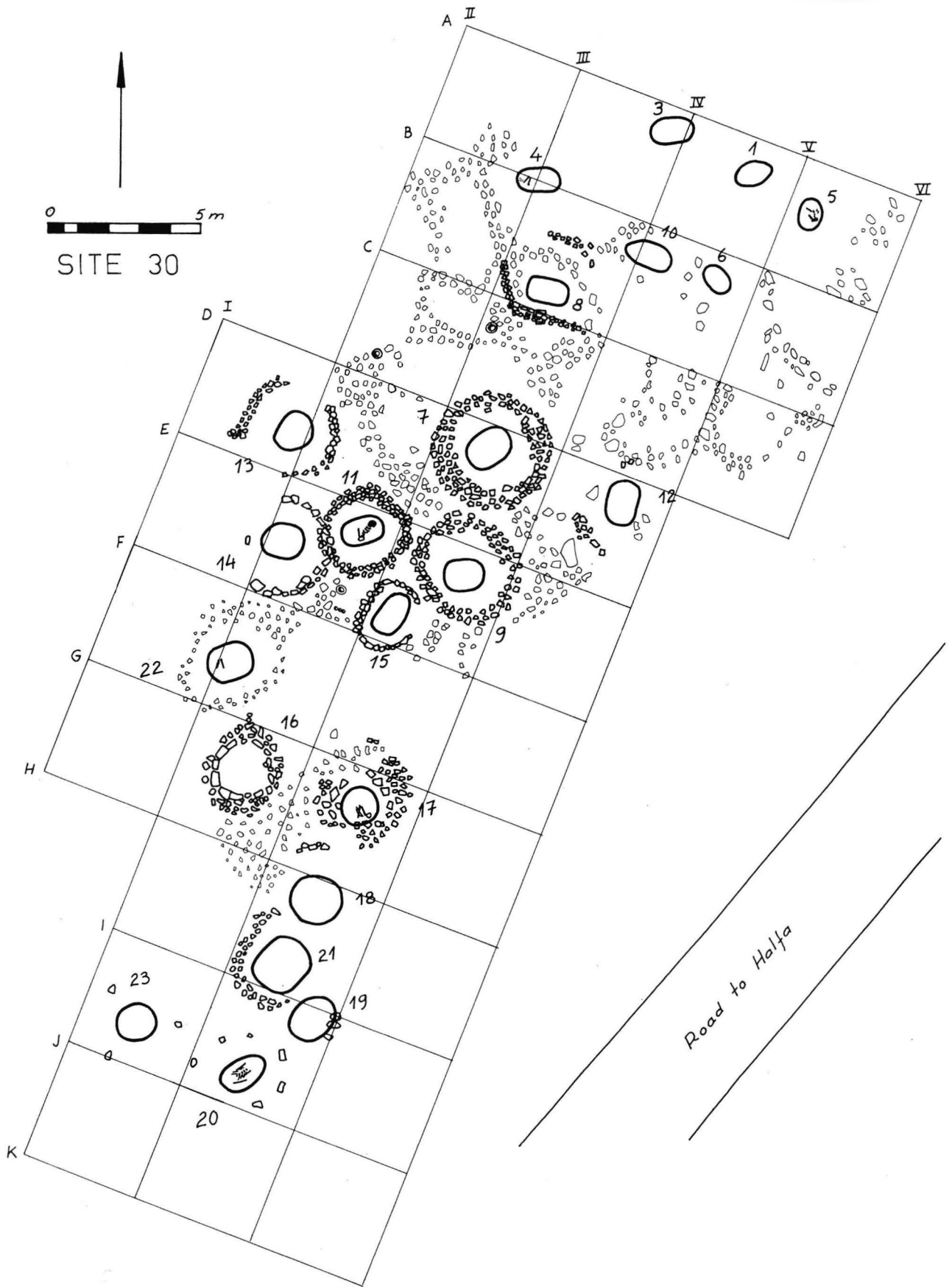

95. Site 30. Plan.

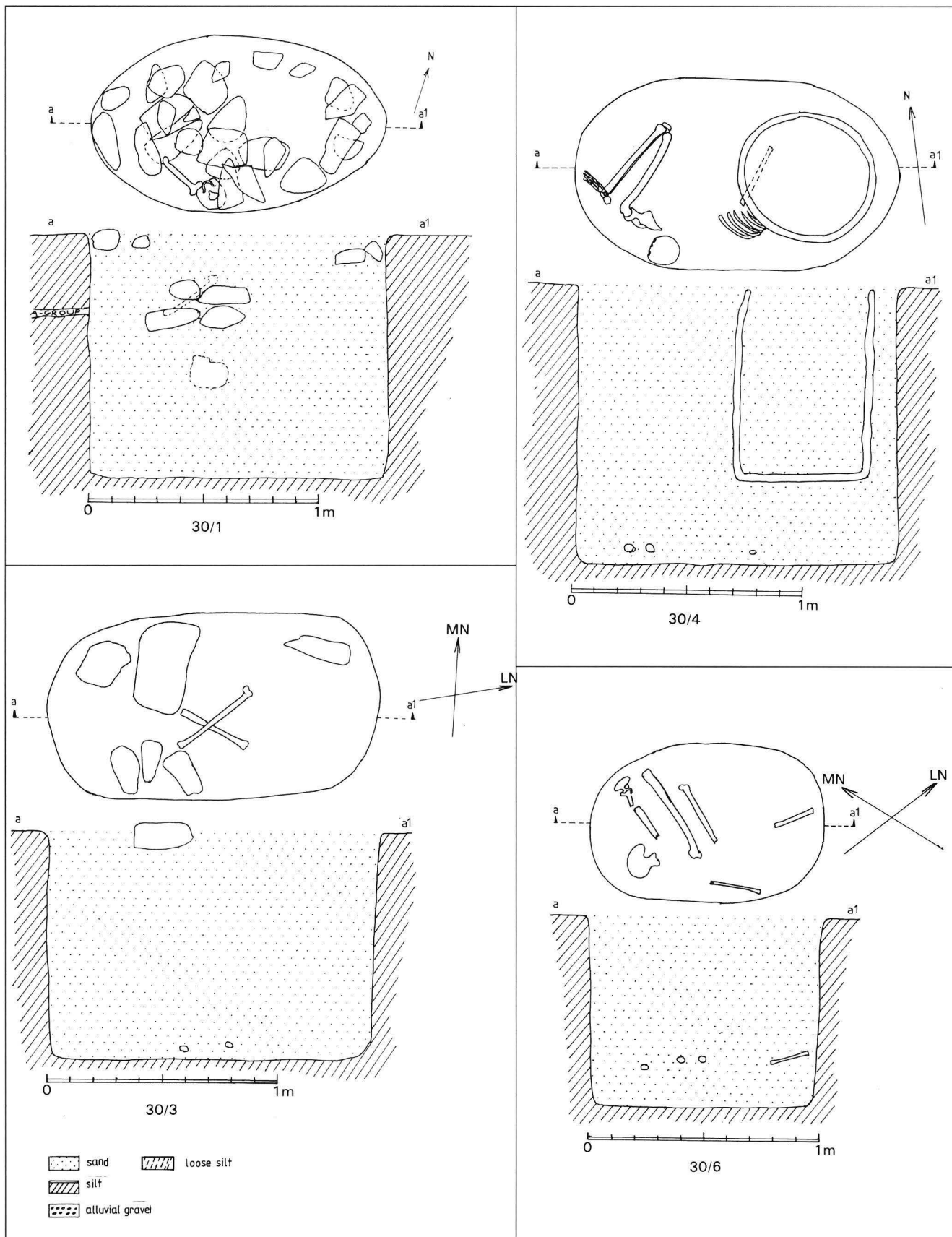

96. Site 30/1,3,4,6.

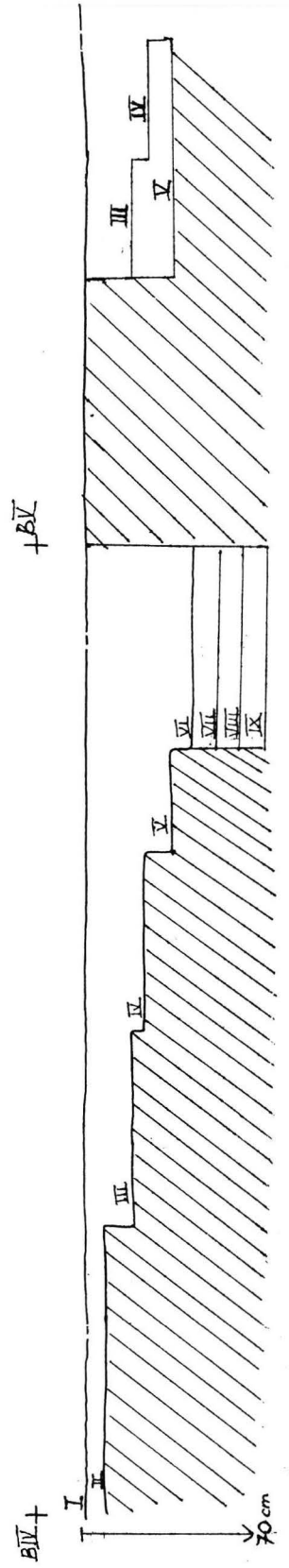
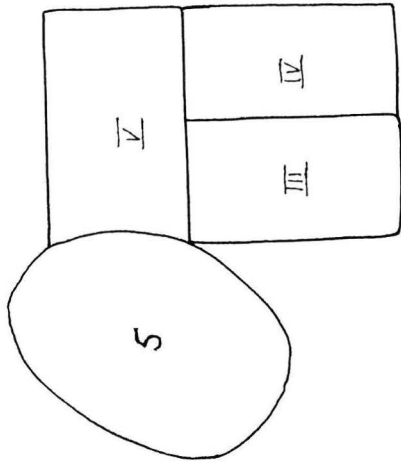
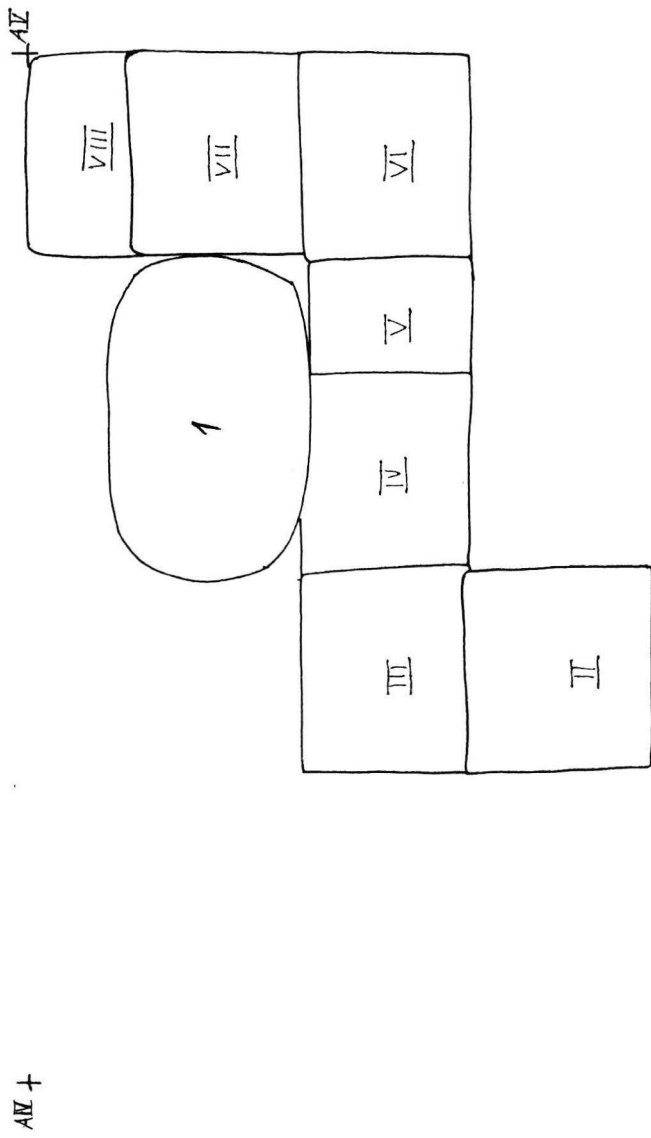

97. Site 30A. A-group layers BIV–BV. Graves 30/1,2.

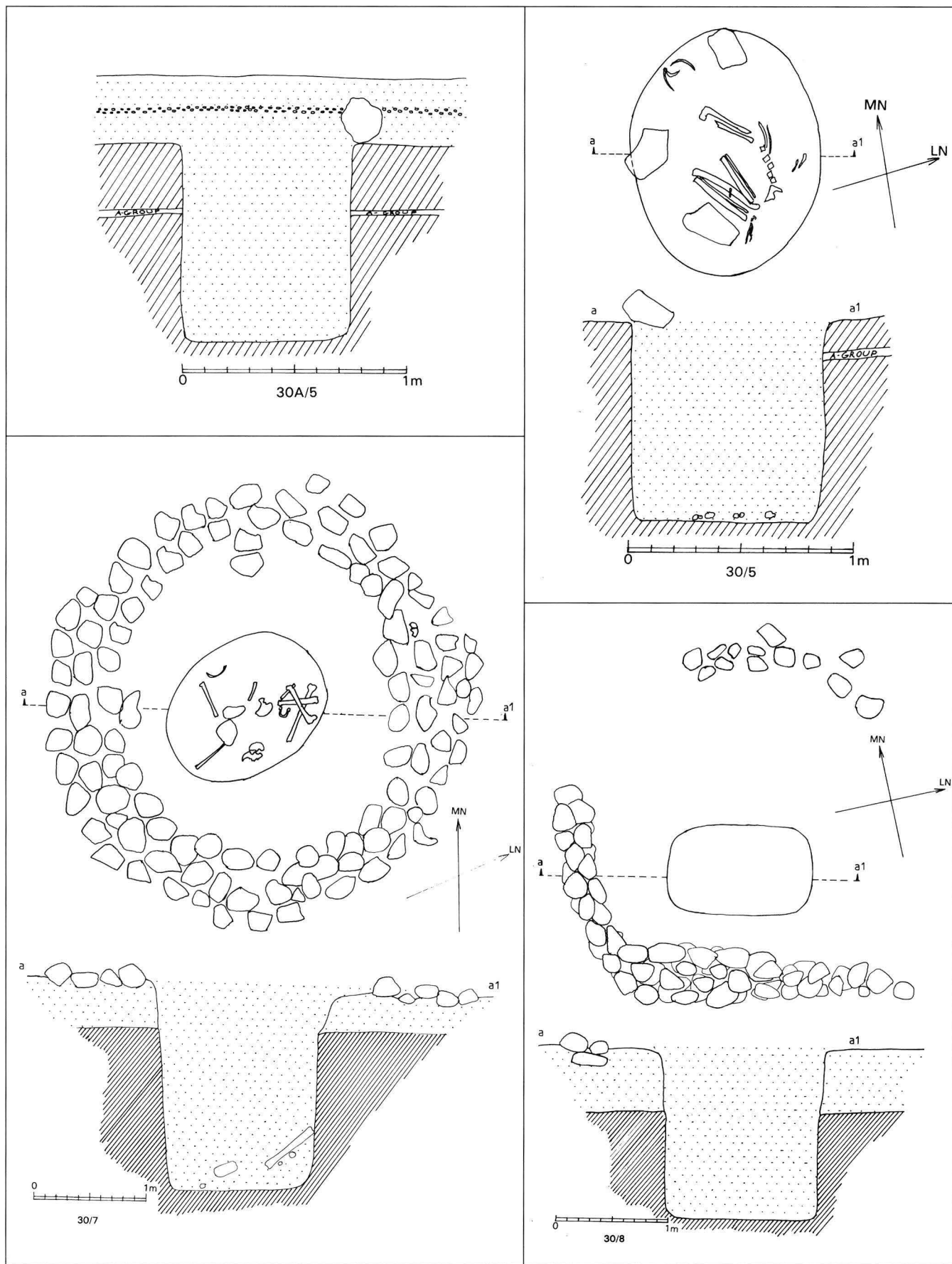

98. Site 30A/5, 30/5,7,8.

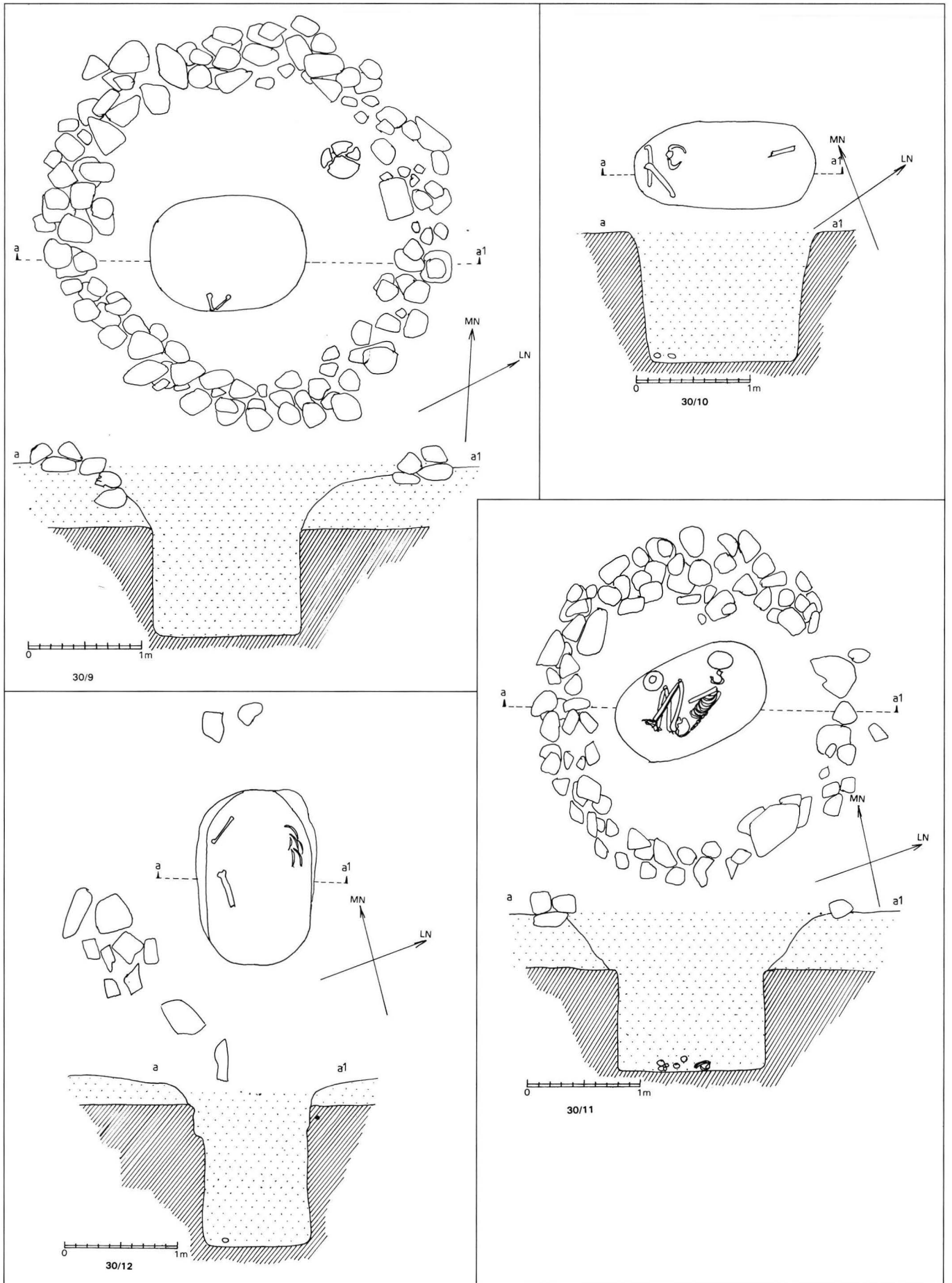

99. Site 30/9-12.

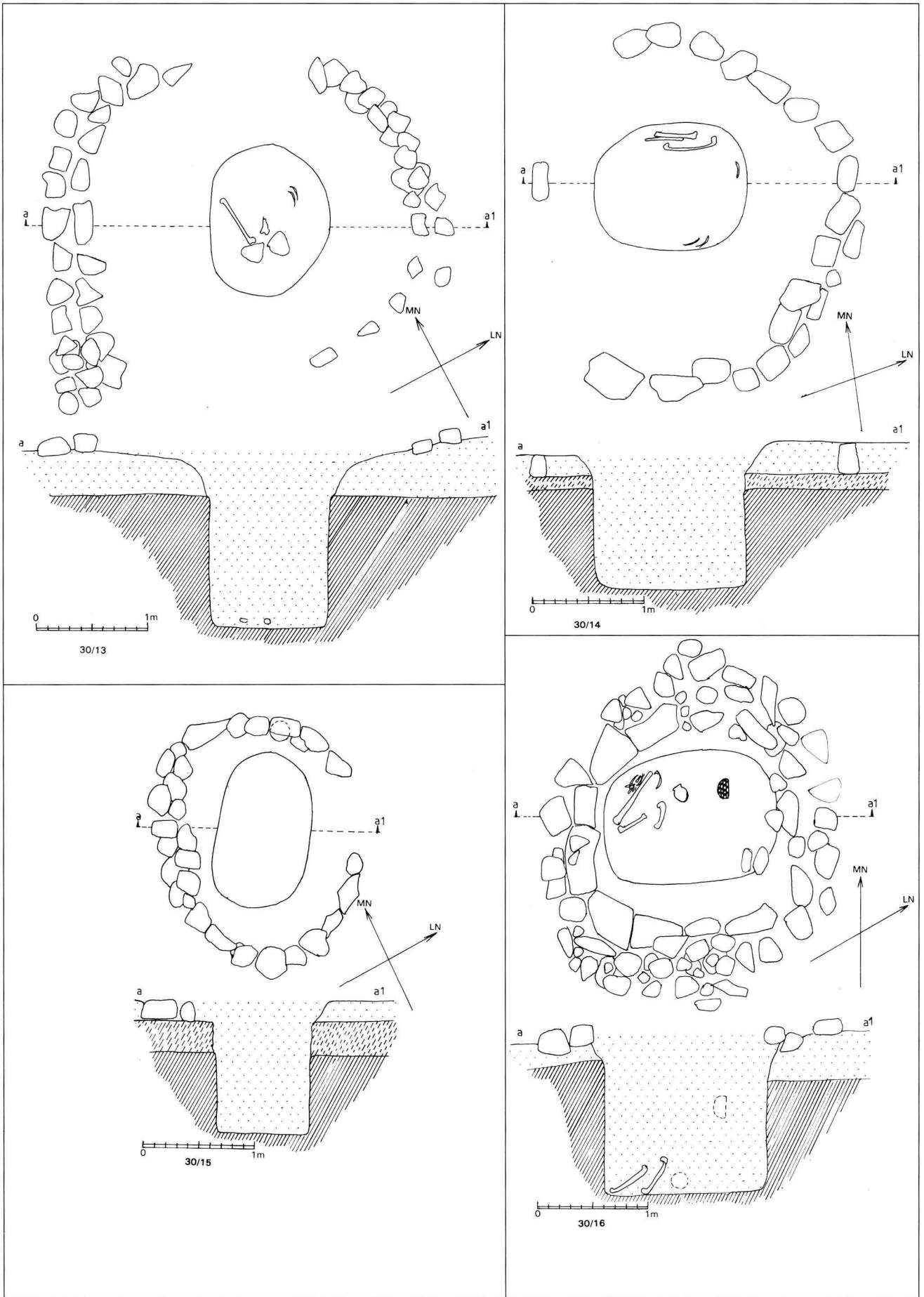

100. Site 30/13-16.

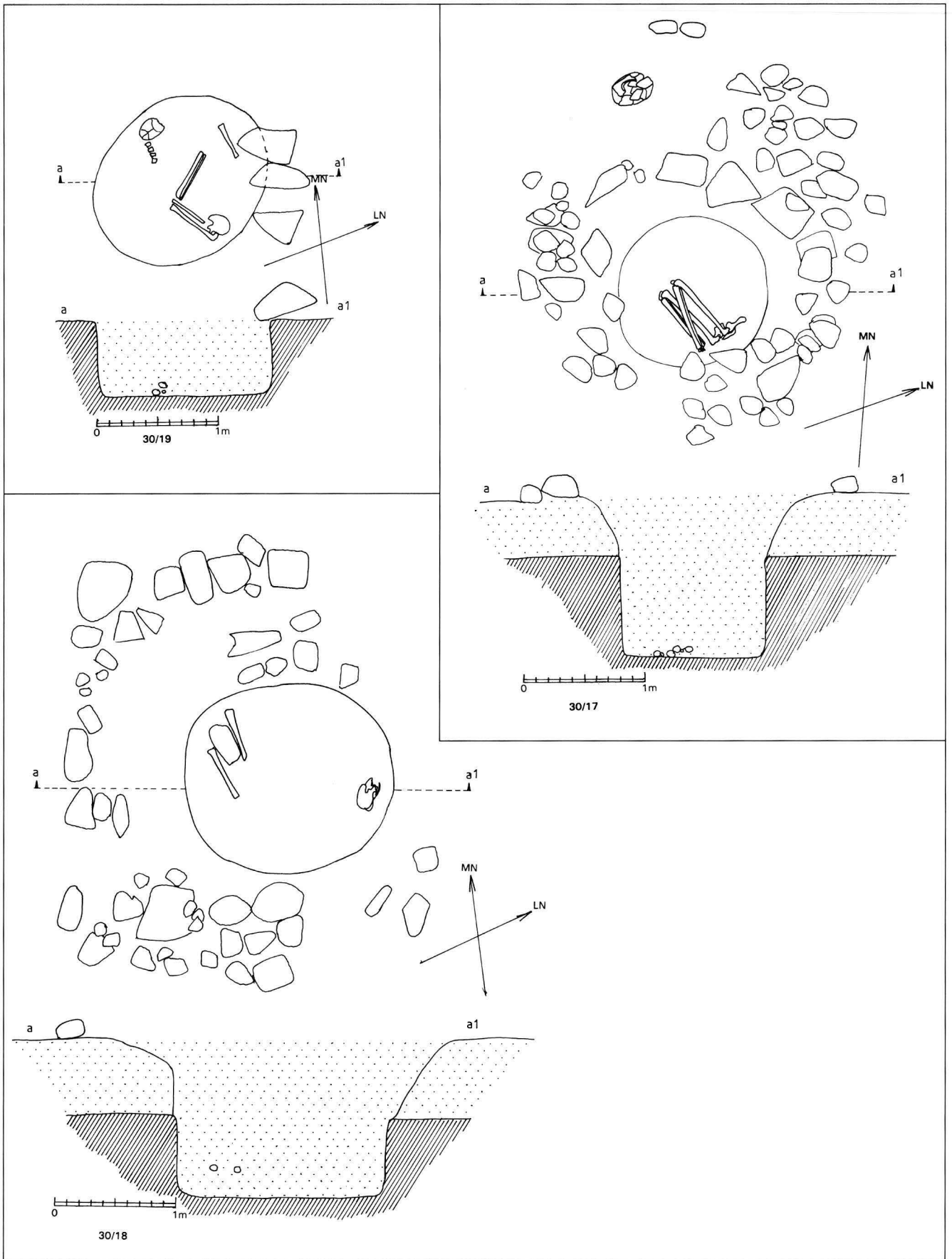

101. Site 30/17-19.

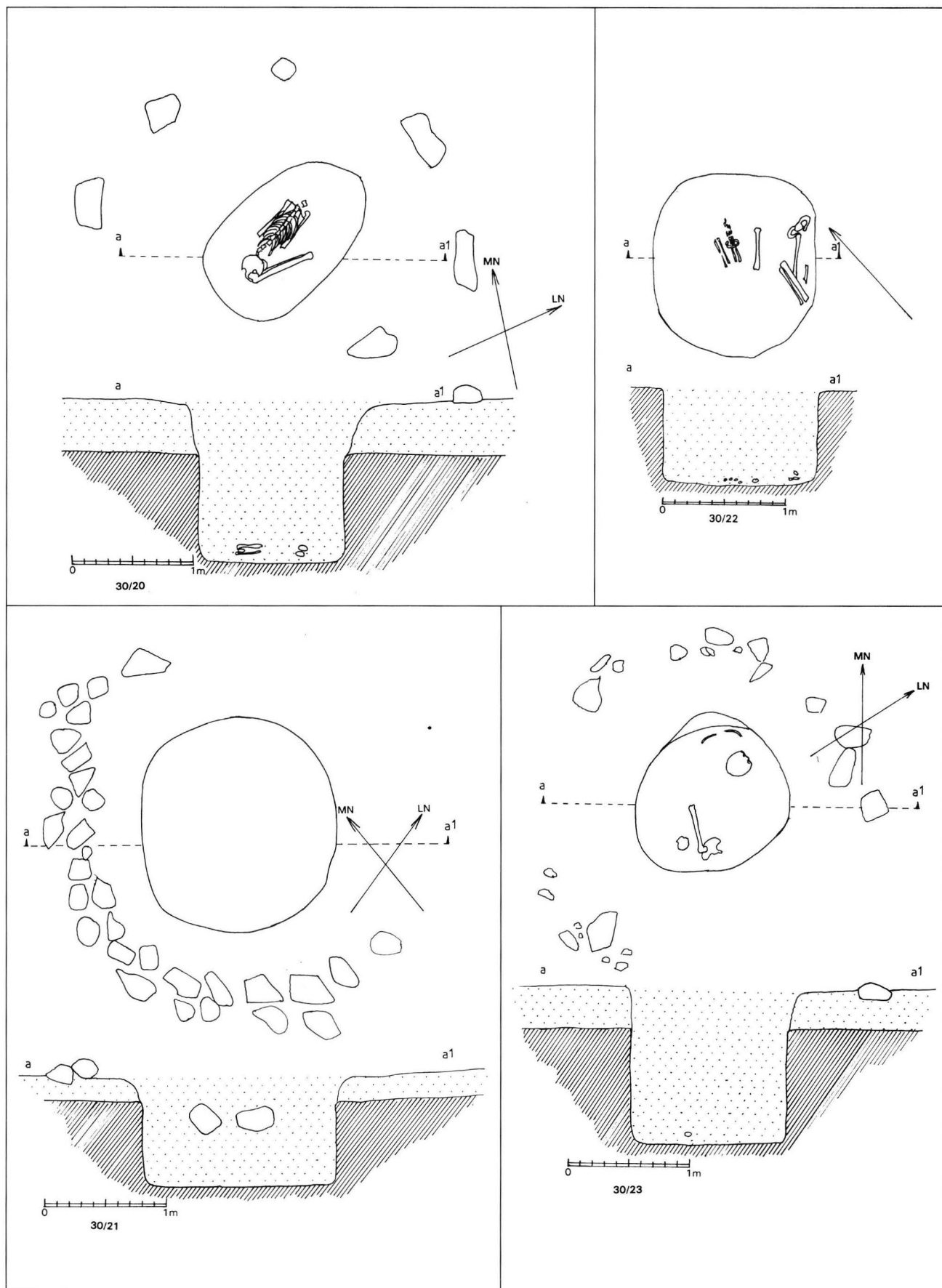

102. Site 30/20–23.



103. View over Nag Sigaga Plain.

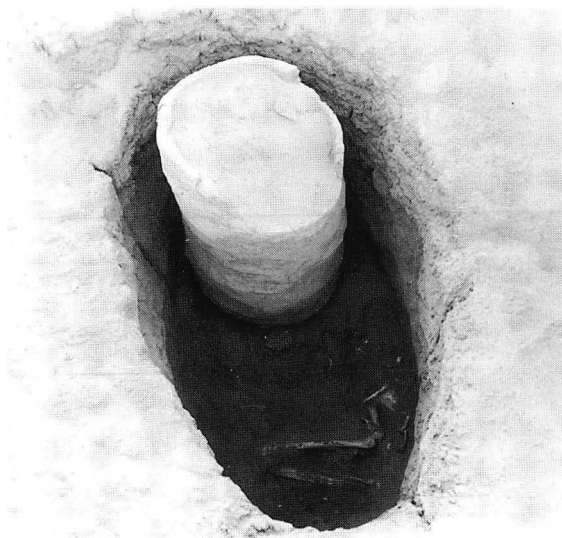

1.

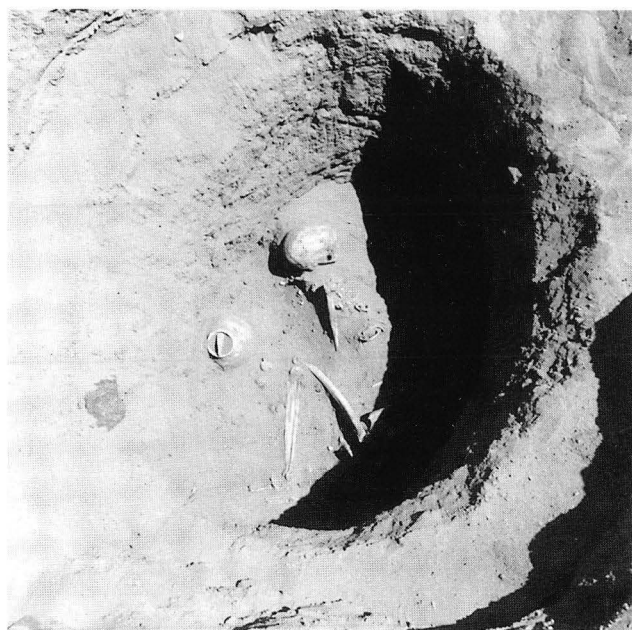

2.



3.

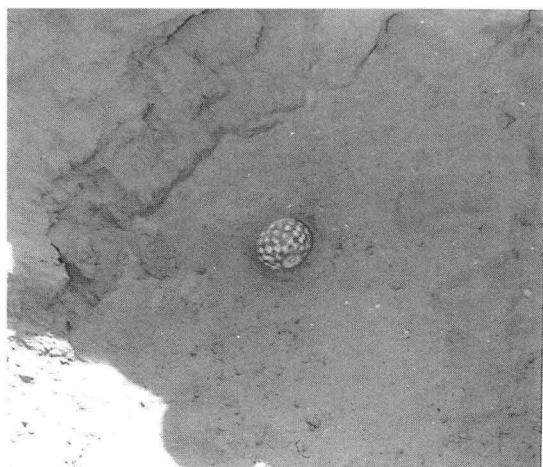

4.



5.

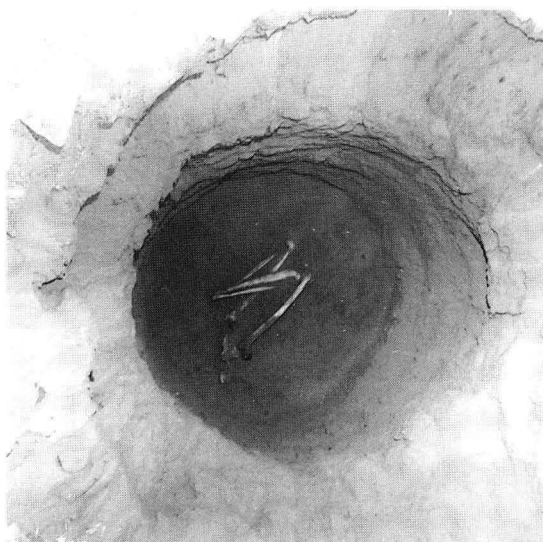

6.

104. 1. Silo and a body in the shaft (30/4). 2. Body and pottery in the shaft (30/11:1). 3-4. Sealing and pottery in situ (30/16:1). 5-6. Before excavation, from S and a body in the shaft (30/17).



1.



2.



3.



4.

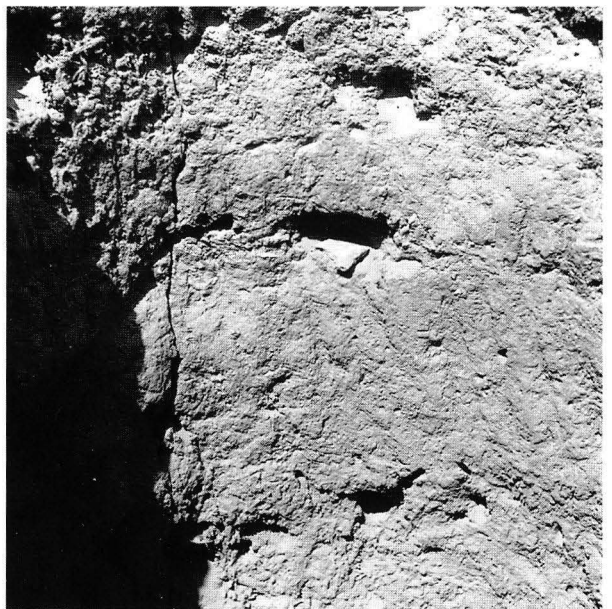

5.

105. 1. Body in the shaft (30/22). 2. CII:01 in situ. 3-4. Site 30A, from E and S. 5. A-group sherds in the shaft wall (30/1).

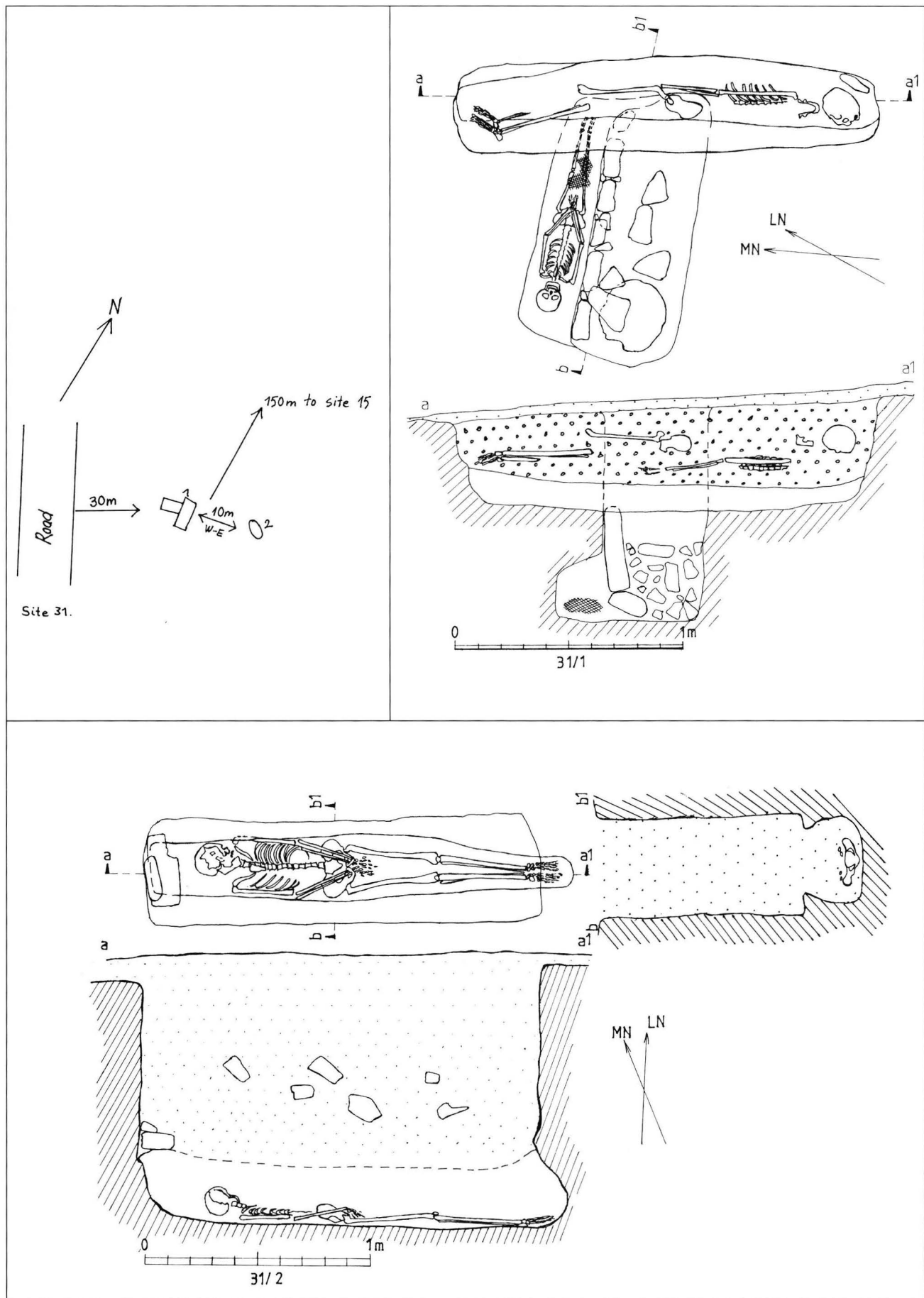

106. Site 31. Topo sketch.

107. Site 31/1-2.

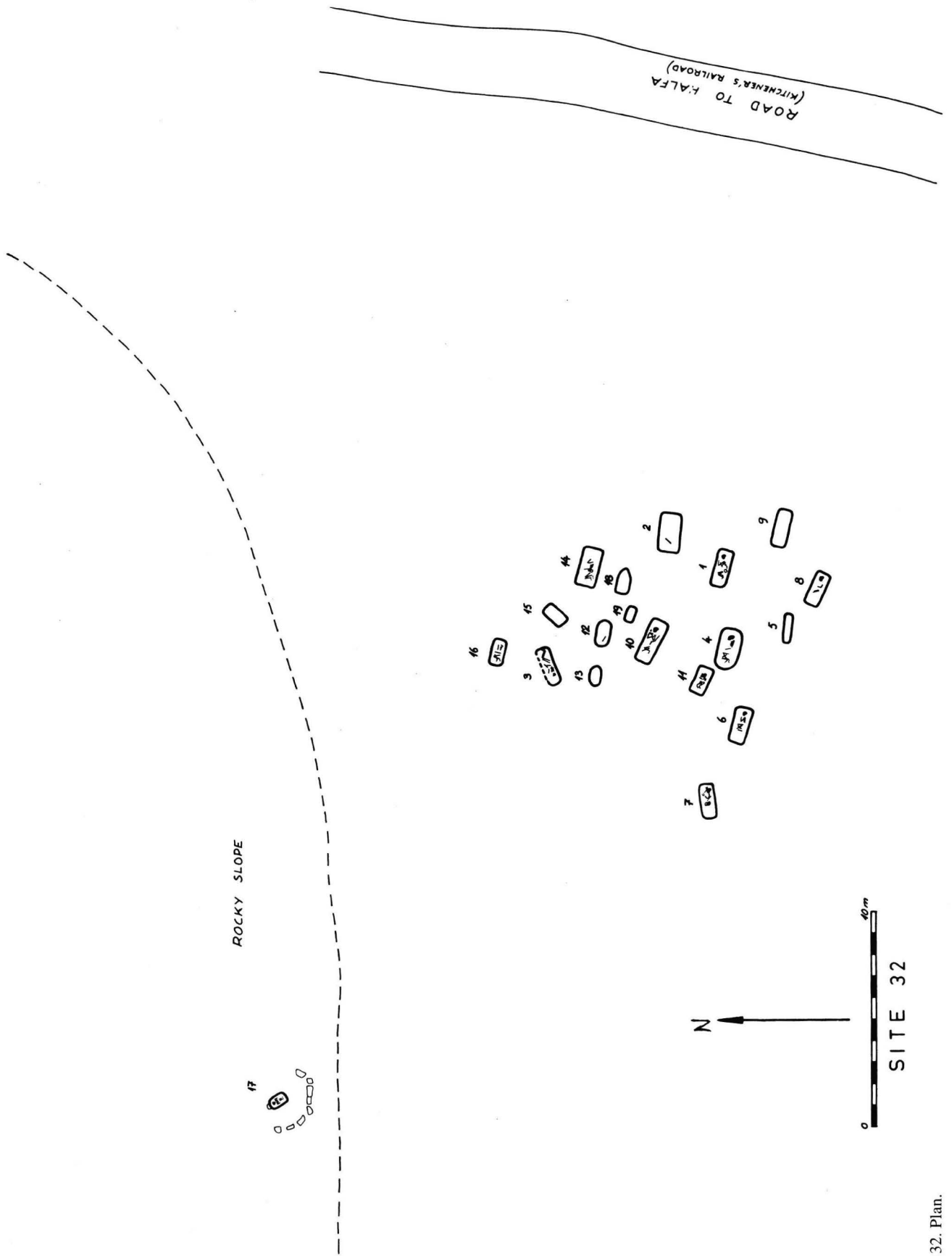

108. Site 32. Plan.

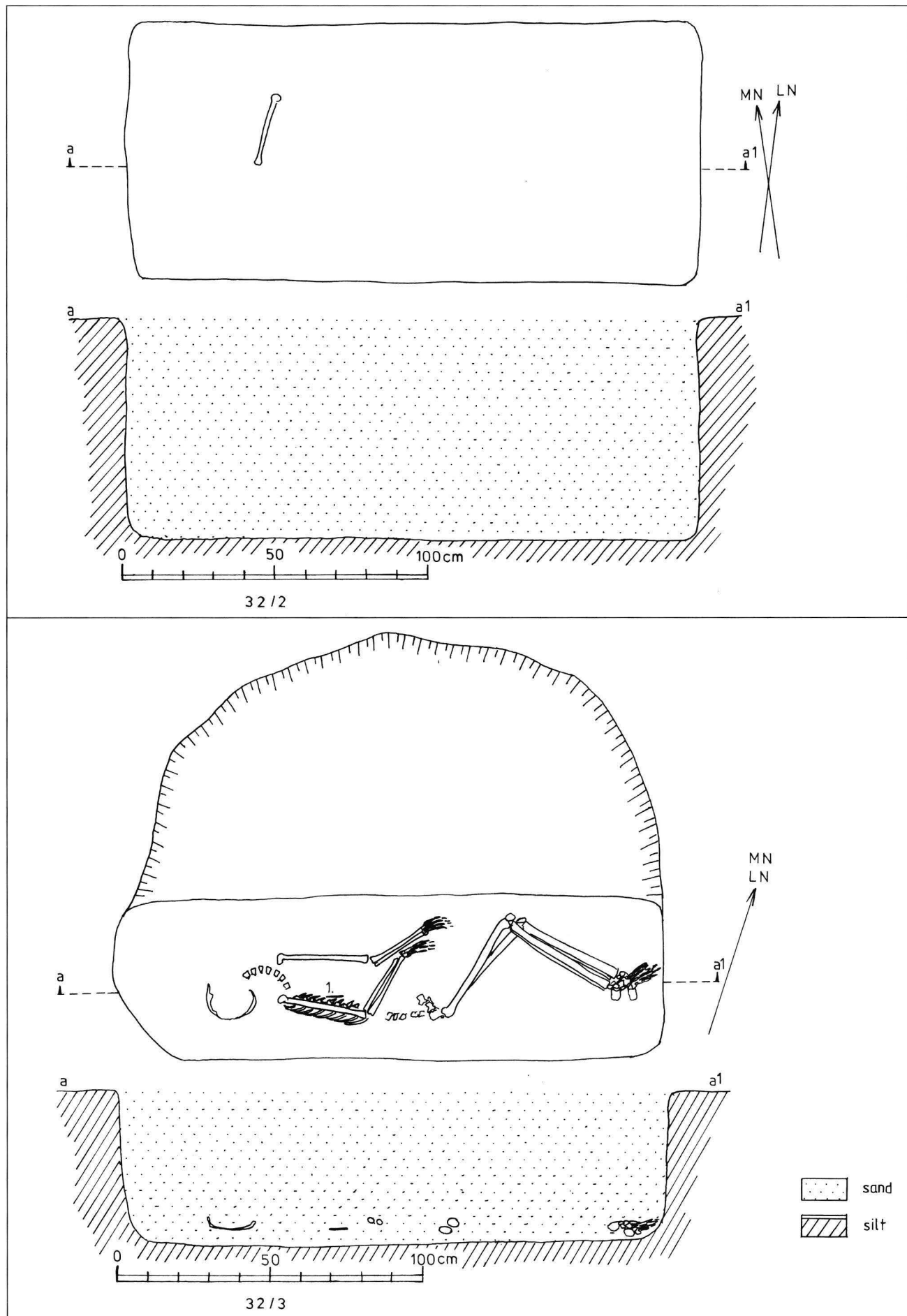

109. Site 32/2,3.

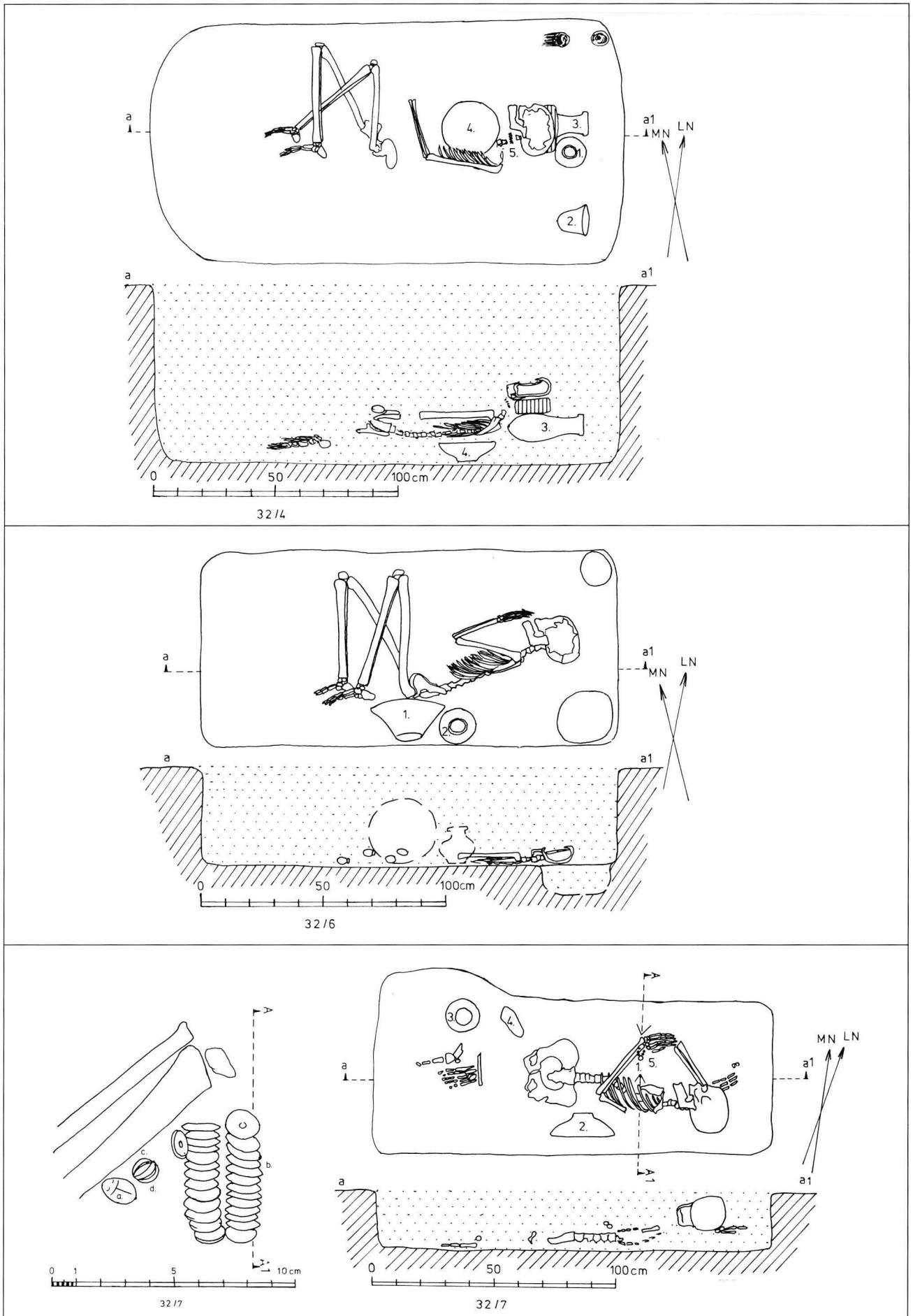

110. Site 32/4,6,7.

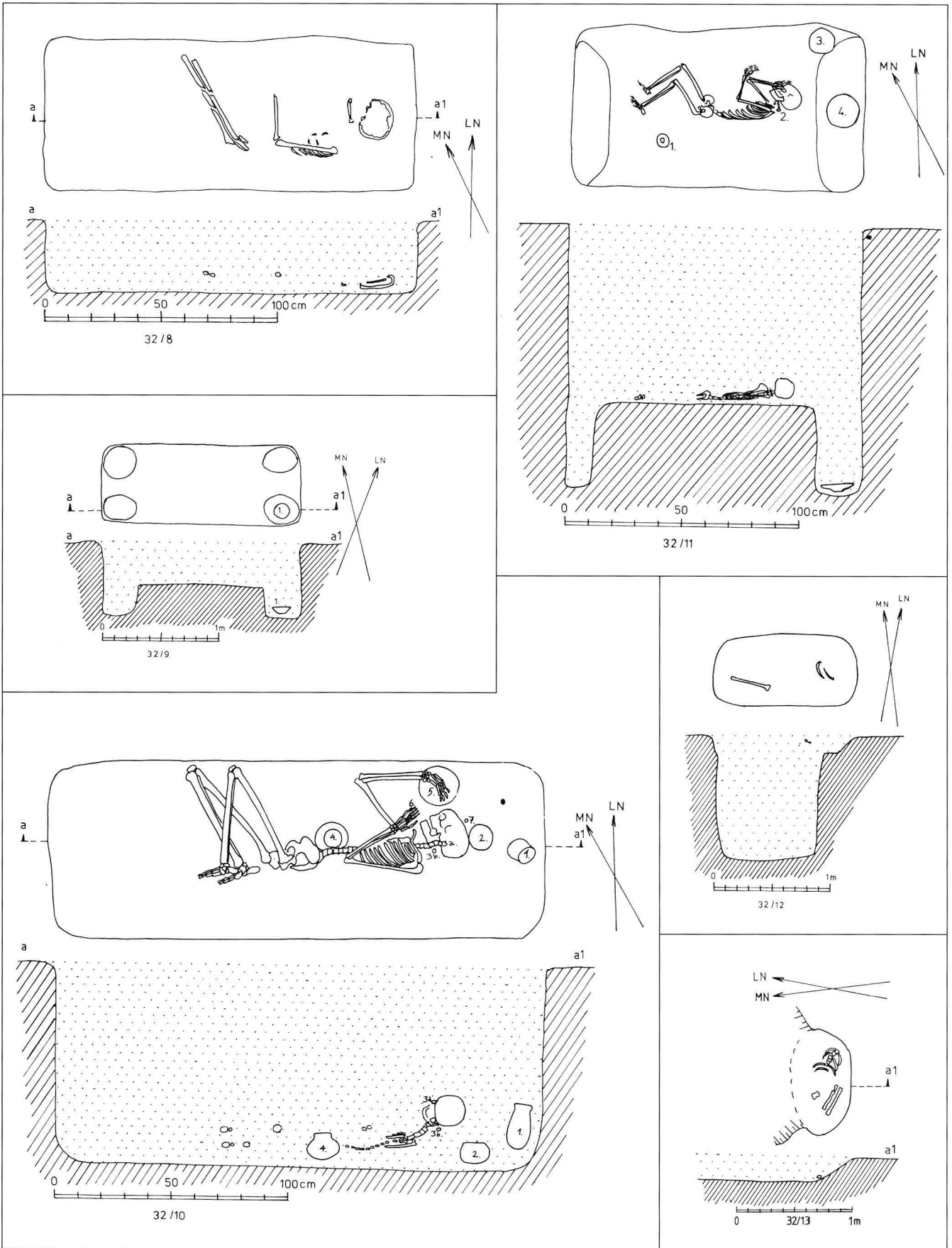

111. Site 32/8-13.

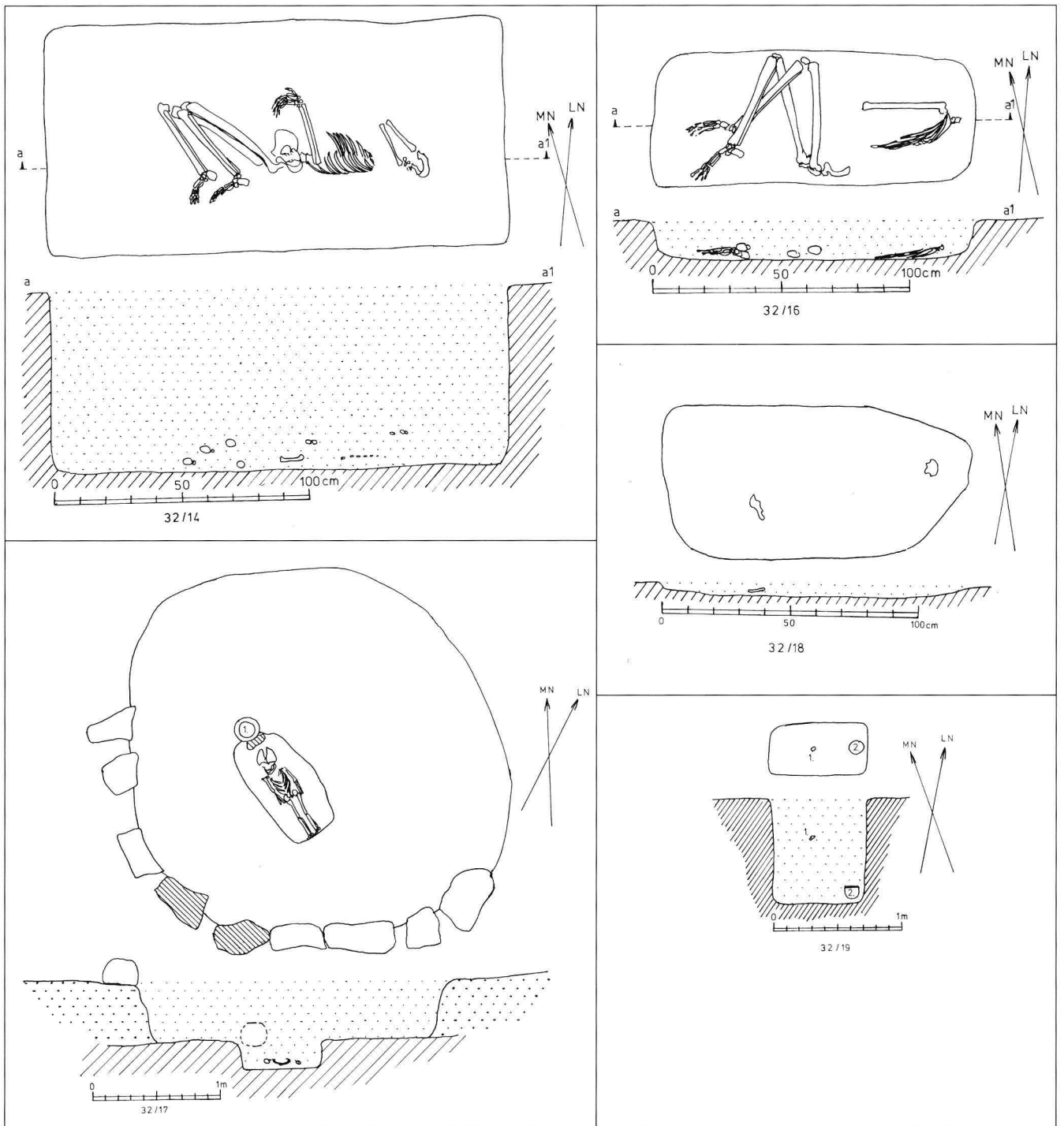

112. Site 32/14,16-19.

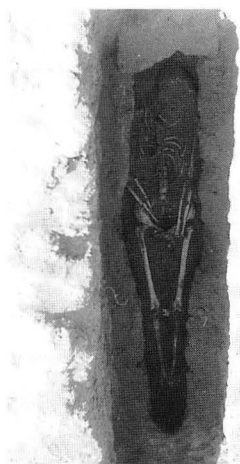

1.



2.



3.



4.

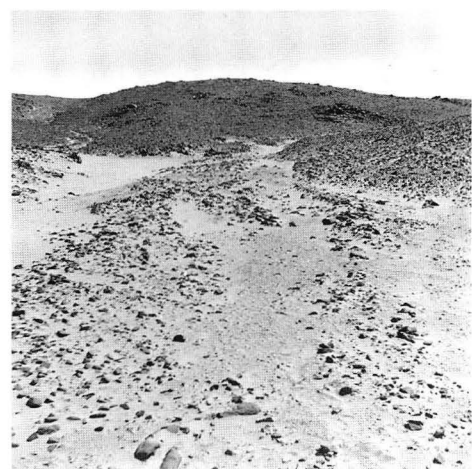

5.



6.



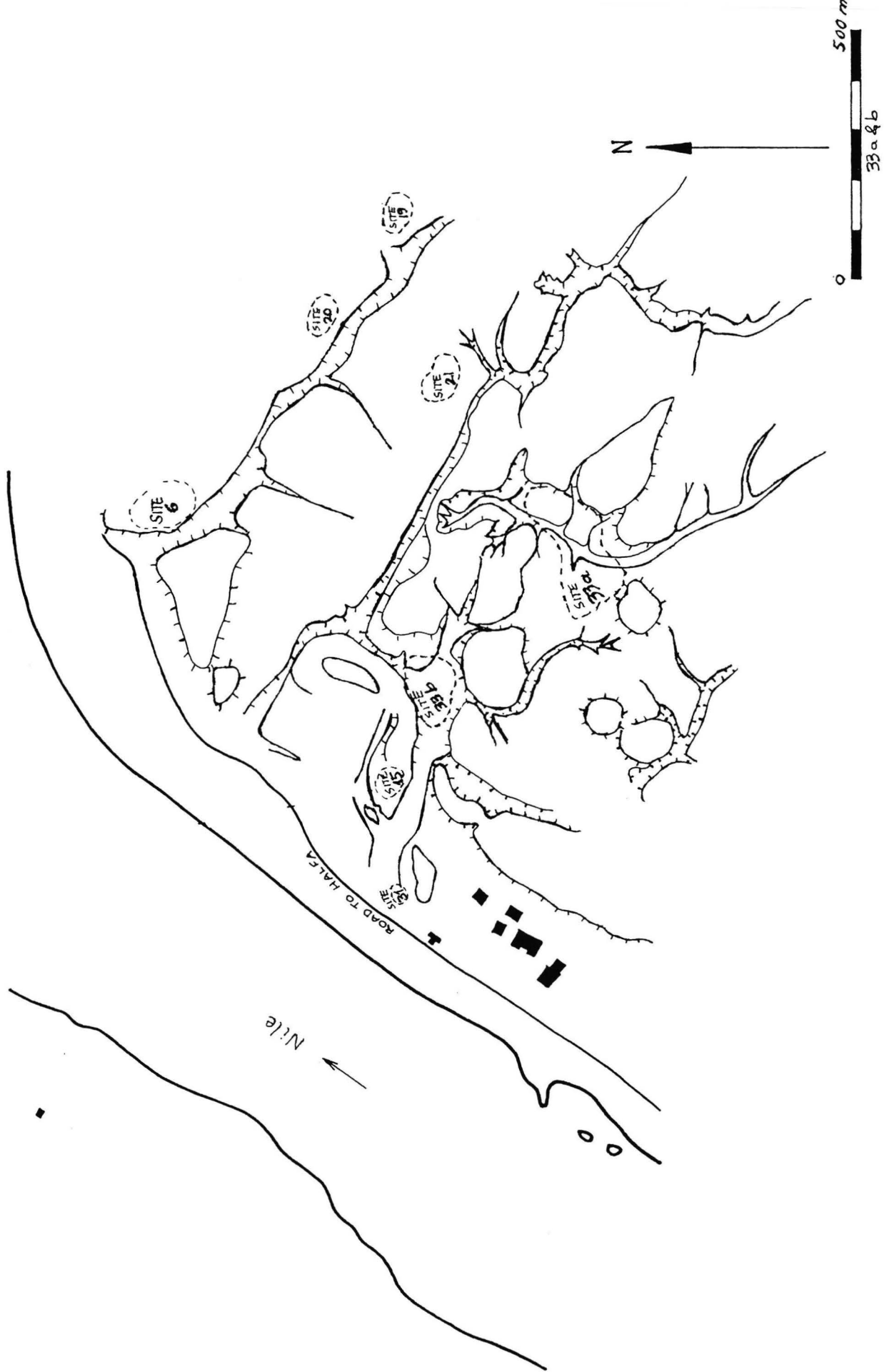

7.

113. 1. Body in the shaft (31/2). 2. Site 32, from N. 3. Body in the shaft, from S (32/17). 4. Site 33b, from the rock in SE. 5. Wadi connecting the sites 33a and 33b, from NW. 6. Site 33a, from W. 7. Hut g, from W (33a).



114. Sites 33a and 33b. Plan.



-  hut bottoms
-  rock
-  pit

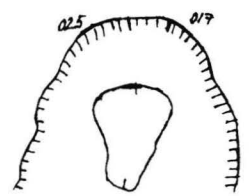
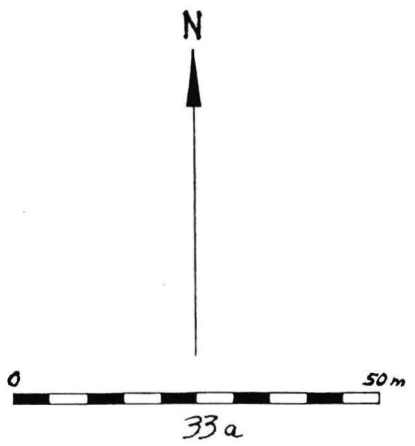

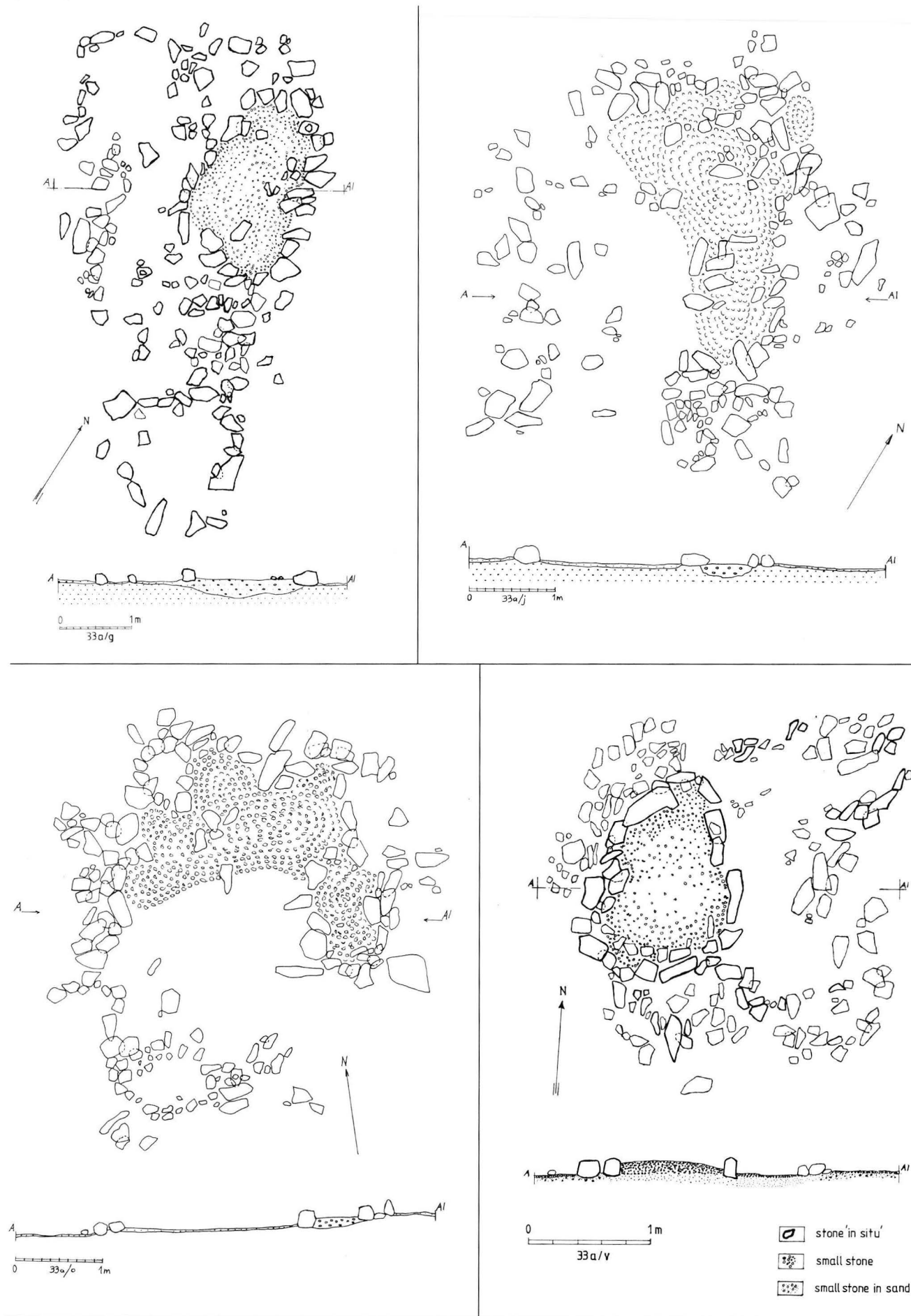

116. Site 33a. Hut bottoms g,j,o,v.

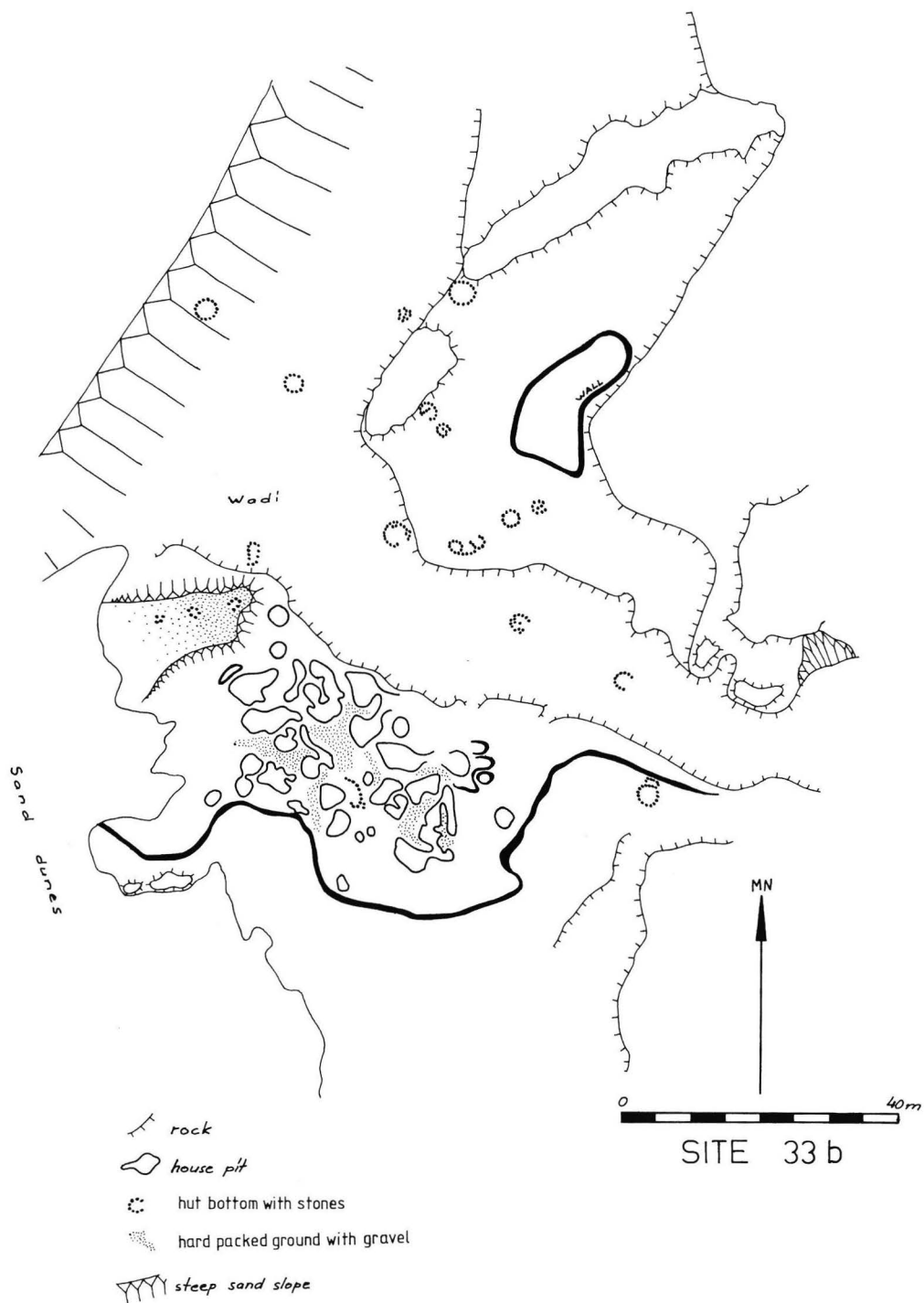

117. Site 33b. Plan.
118. Site 33b. Profile plan A-B.

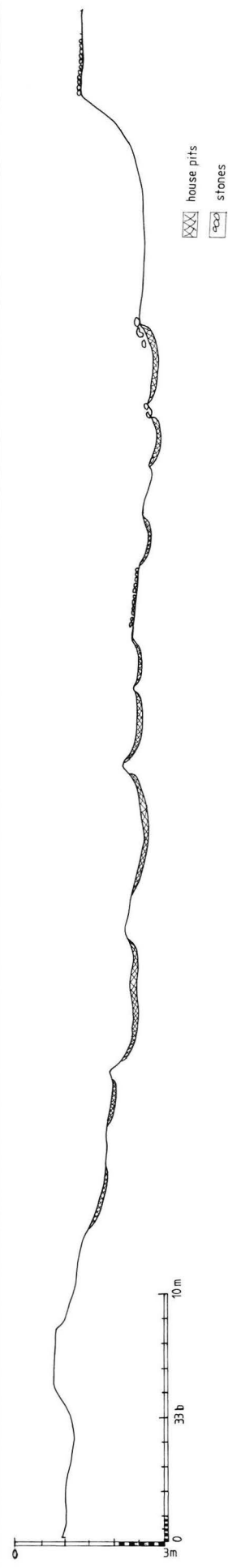

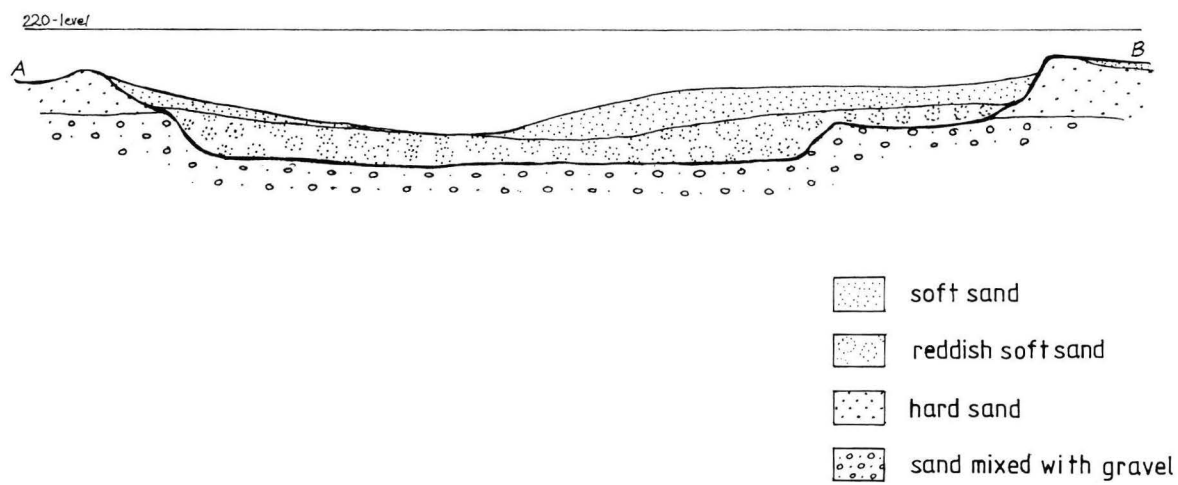
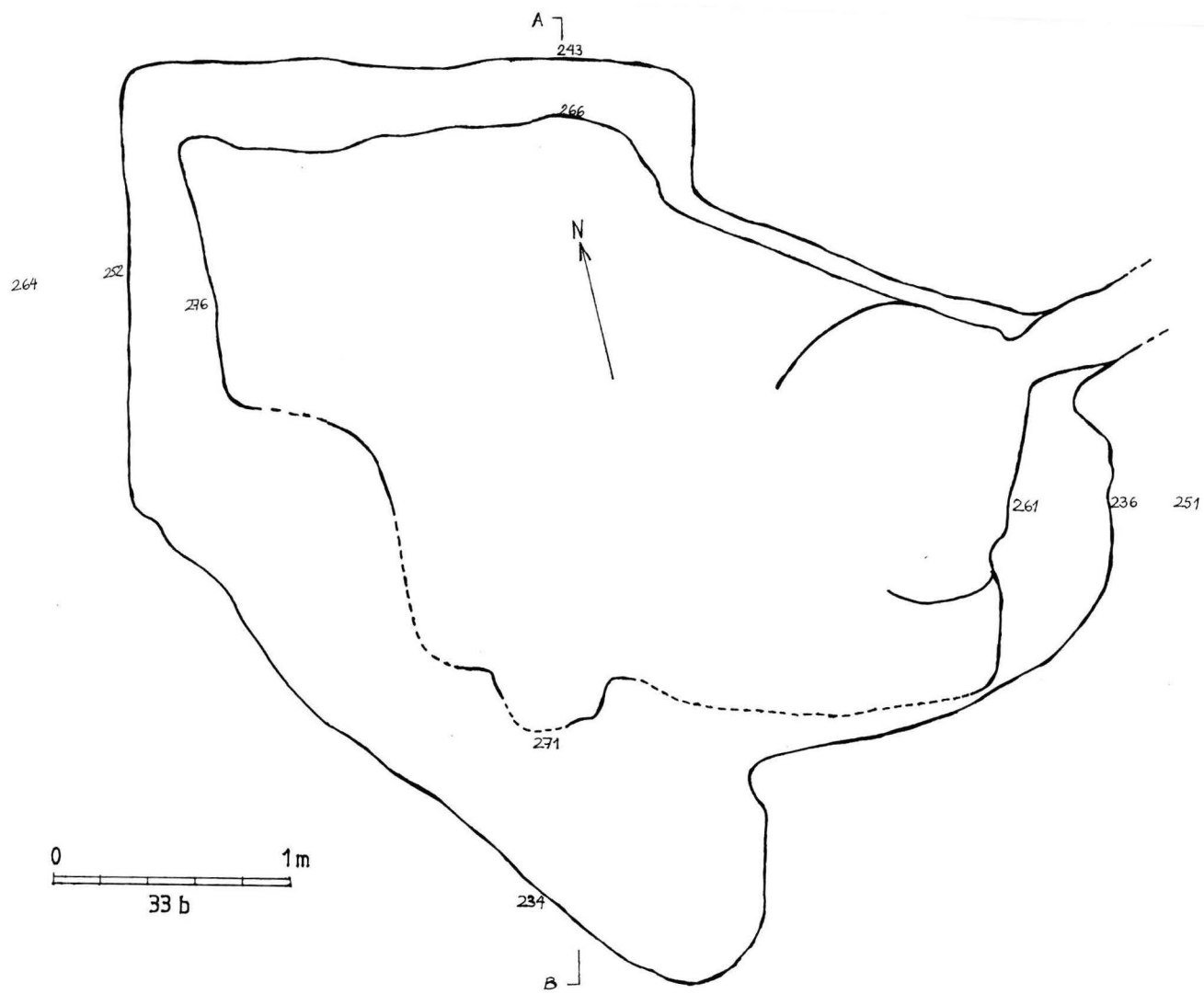

119. Site 33b. Profile plan.

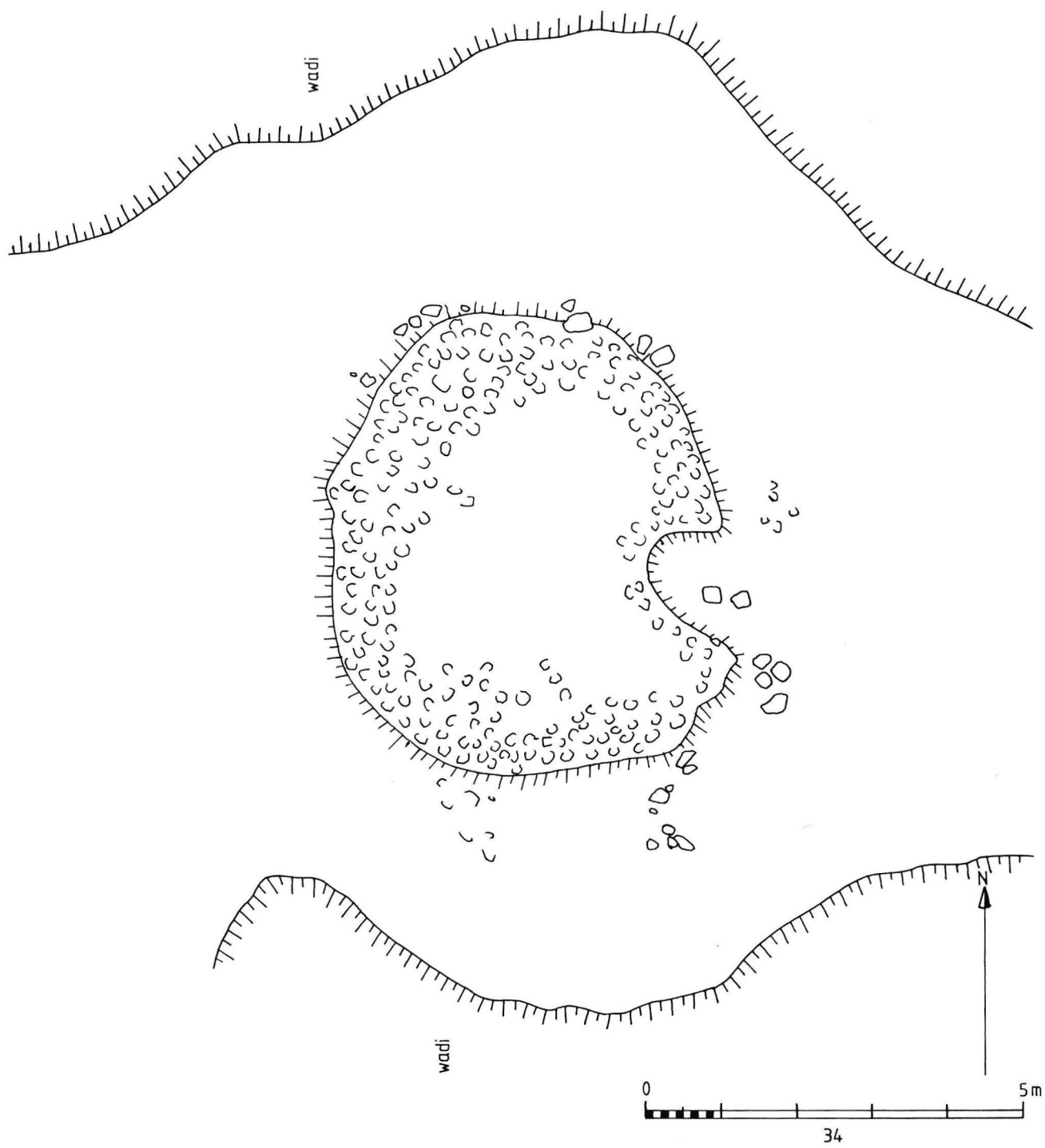

120. Site 34. Plan.



121. Site 34. General plan and profile plans of the habitation area.

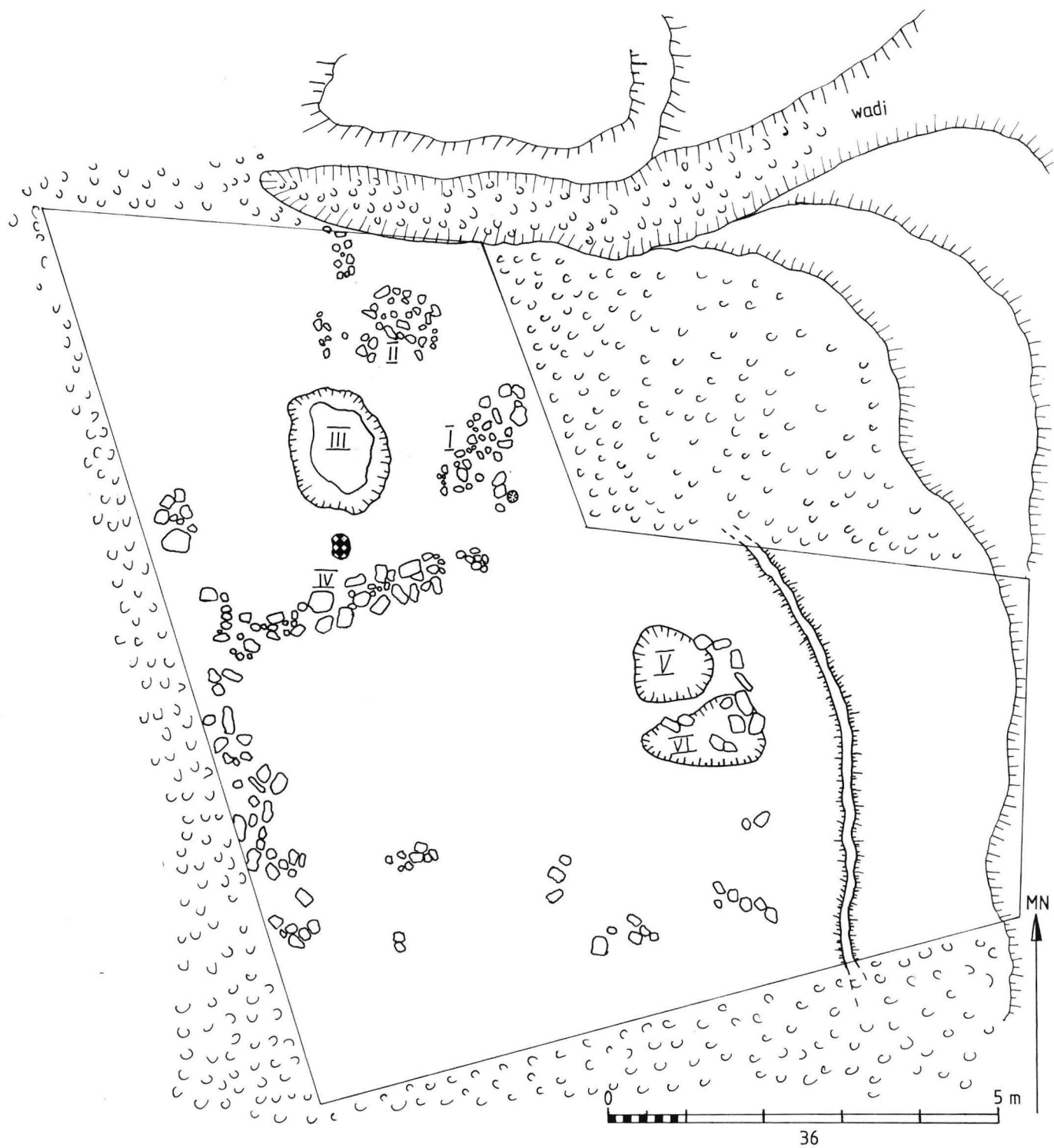

122. Site 36/I-VI. Plan.

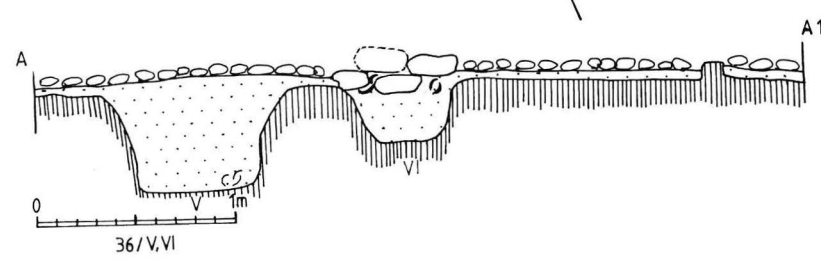
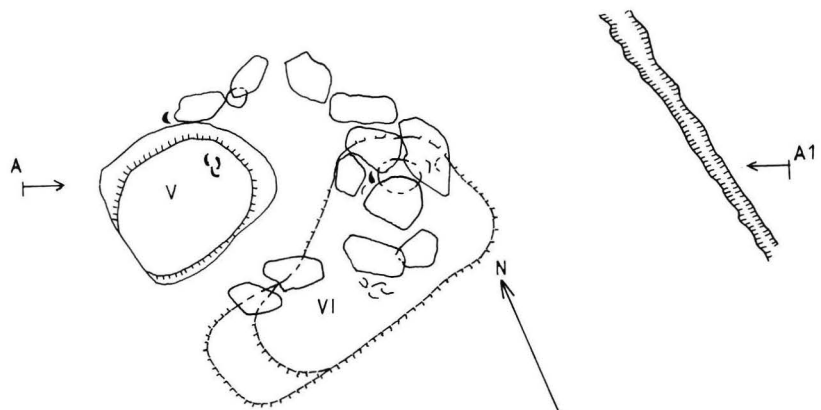
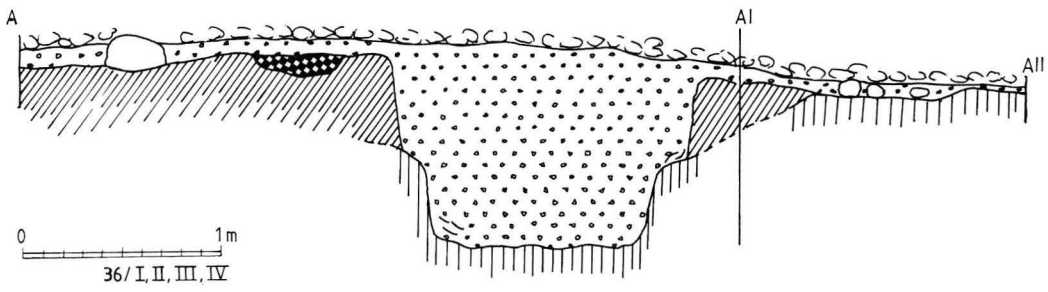
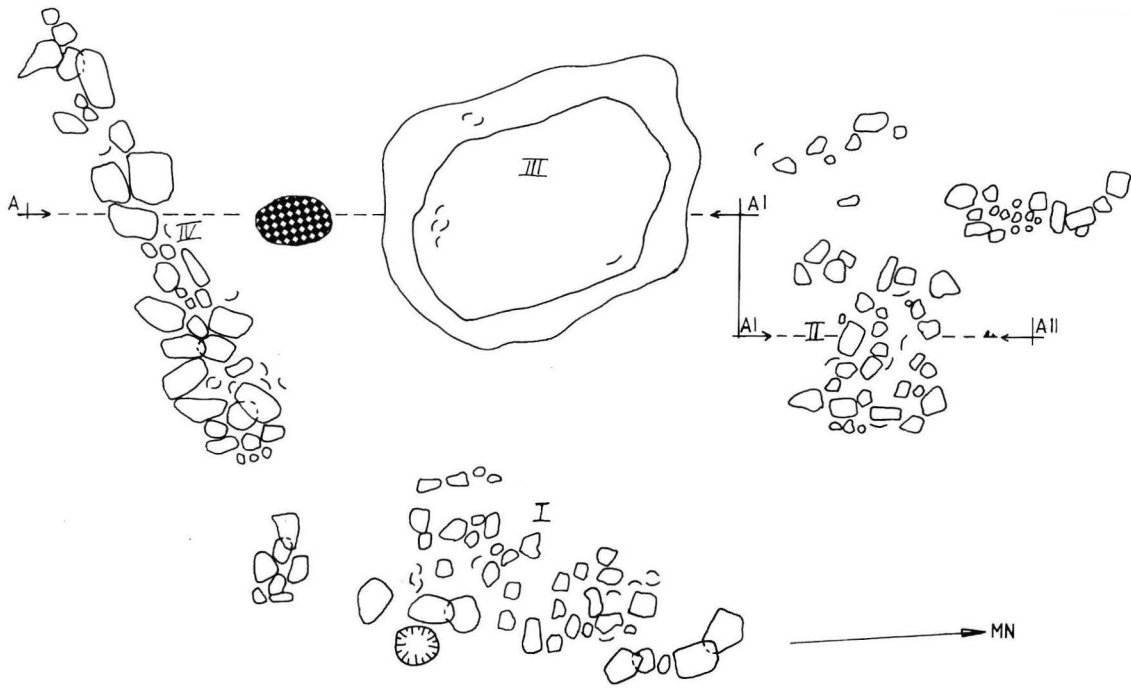

- loose stones
- fast stones
- gravel
- silt
- sand
- ash and coal
- rock
- ceramic sherds

123. Site 36. Pits I-VI.



1.



2.

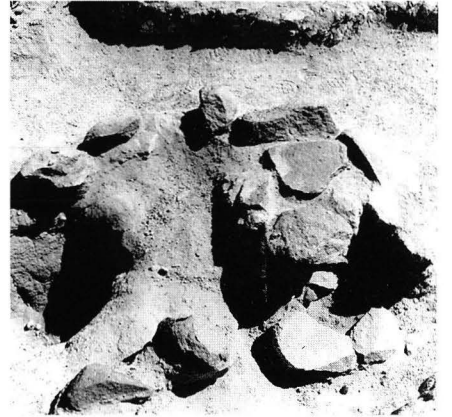

3.



4.

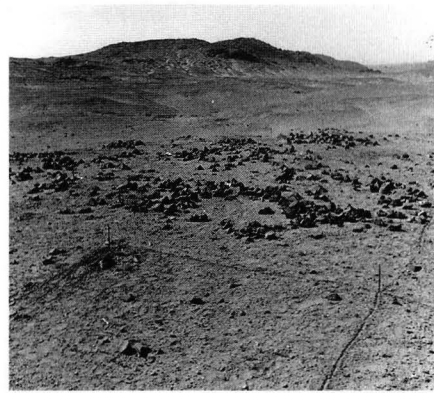

5.



6.

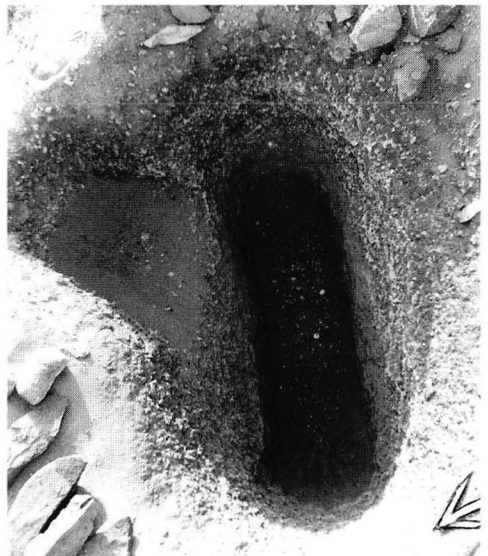

7.

124. 1. Site 34, excavated, from W. 2. Site 36, excavated, from NW. 3. 36/VI, stones on the pit, from E. 4. Site 38, survey to S. 5. Site 38, from N. 6. Site 38, N-part, from S. 7. Emptied (38/31).



1.

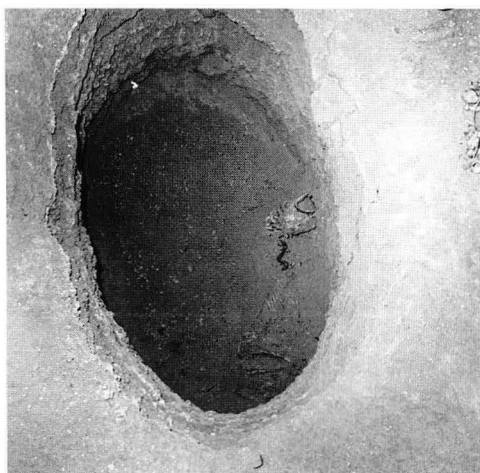

2.



3.



4.



5.

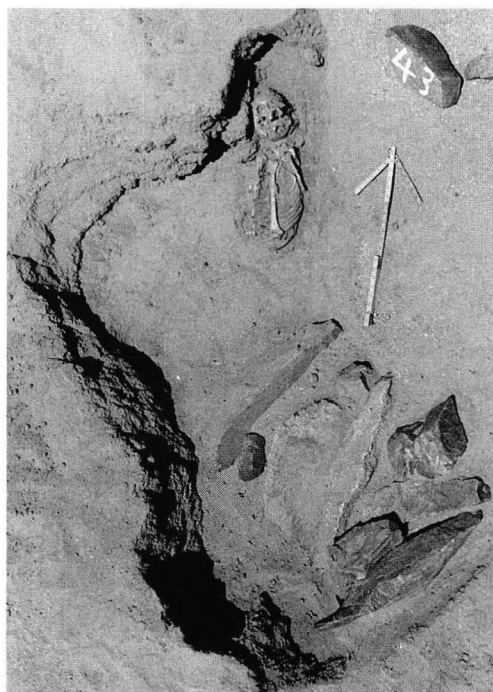

6.

125. 1-2. Sealing and a (child) body in the shaft (38/21). 3. Site 39, under excavation. 4. Sealing and a niche, from W (39/11). 5. Sealing (39/39). 6. Sealing (39/43) and a body in the shaft (39/43A).

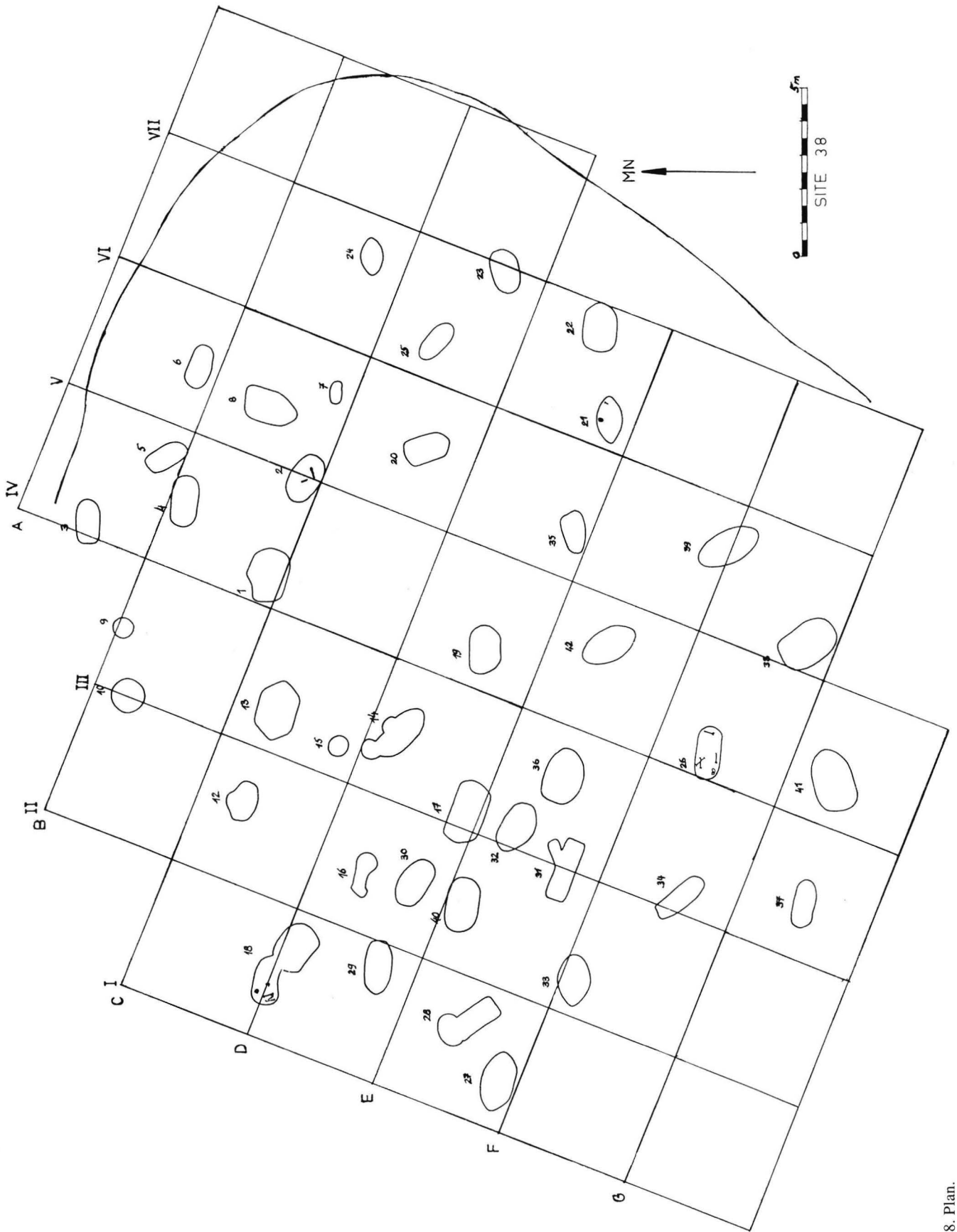

126. Site 38. Plan.

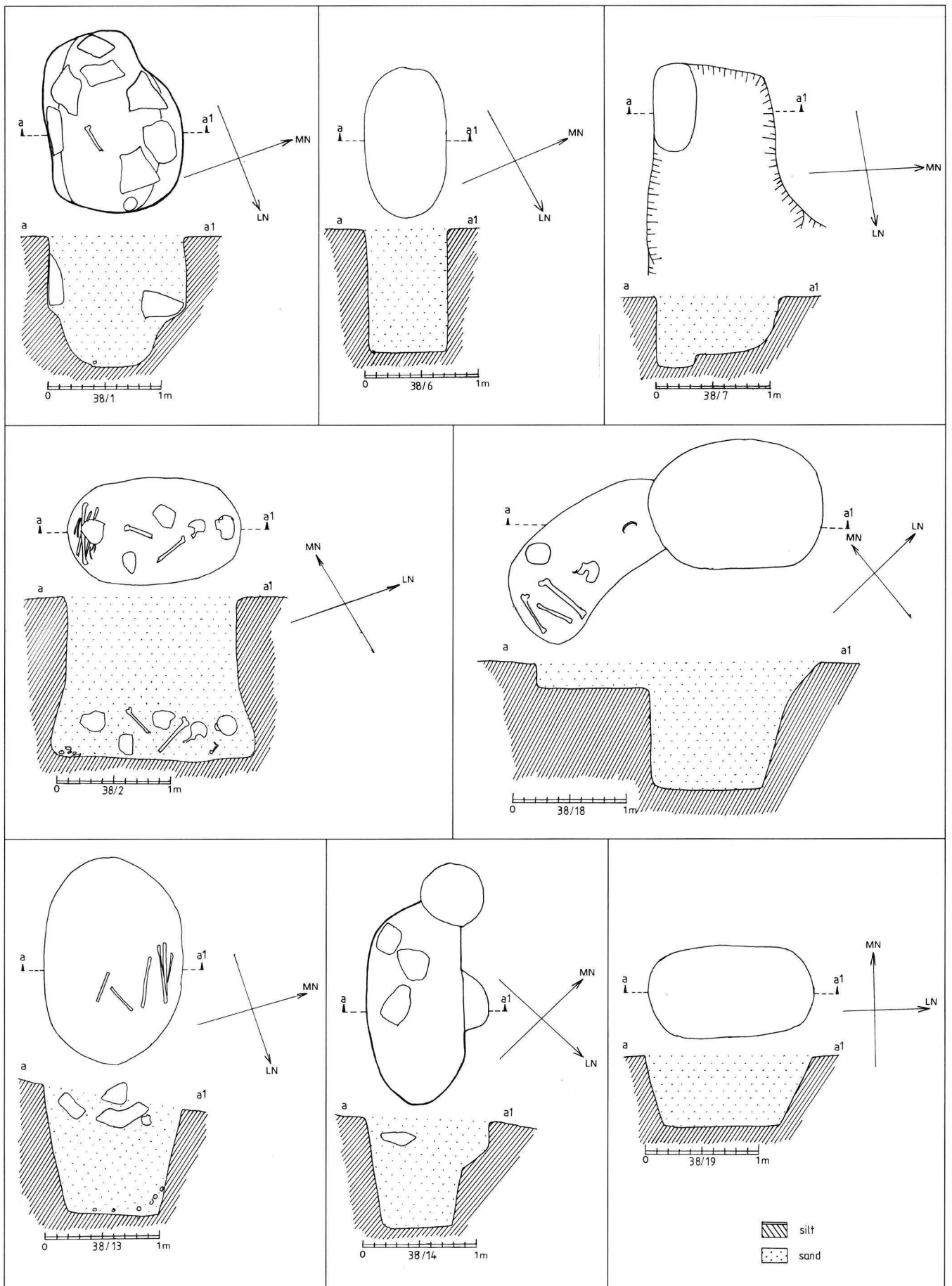

127. Site 38/1,2,6,7,13,14,18,19.

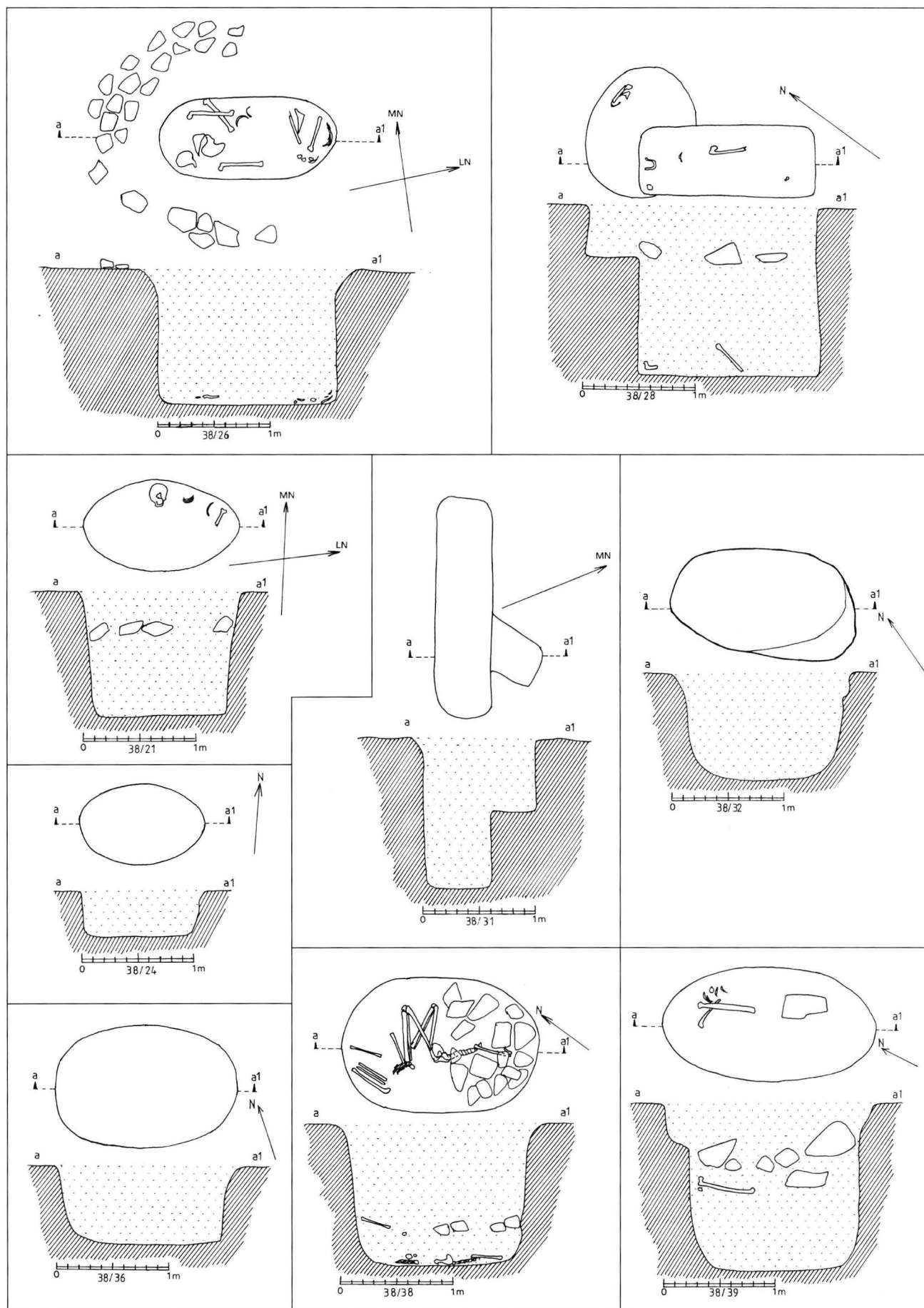

128. Site 38/21,24,26,28,31,32,36,38,39.

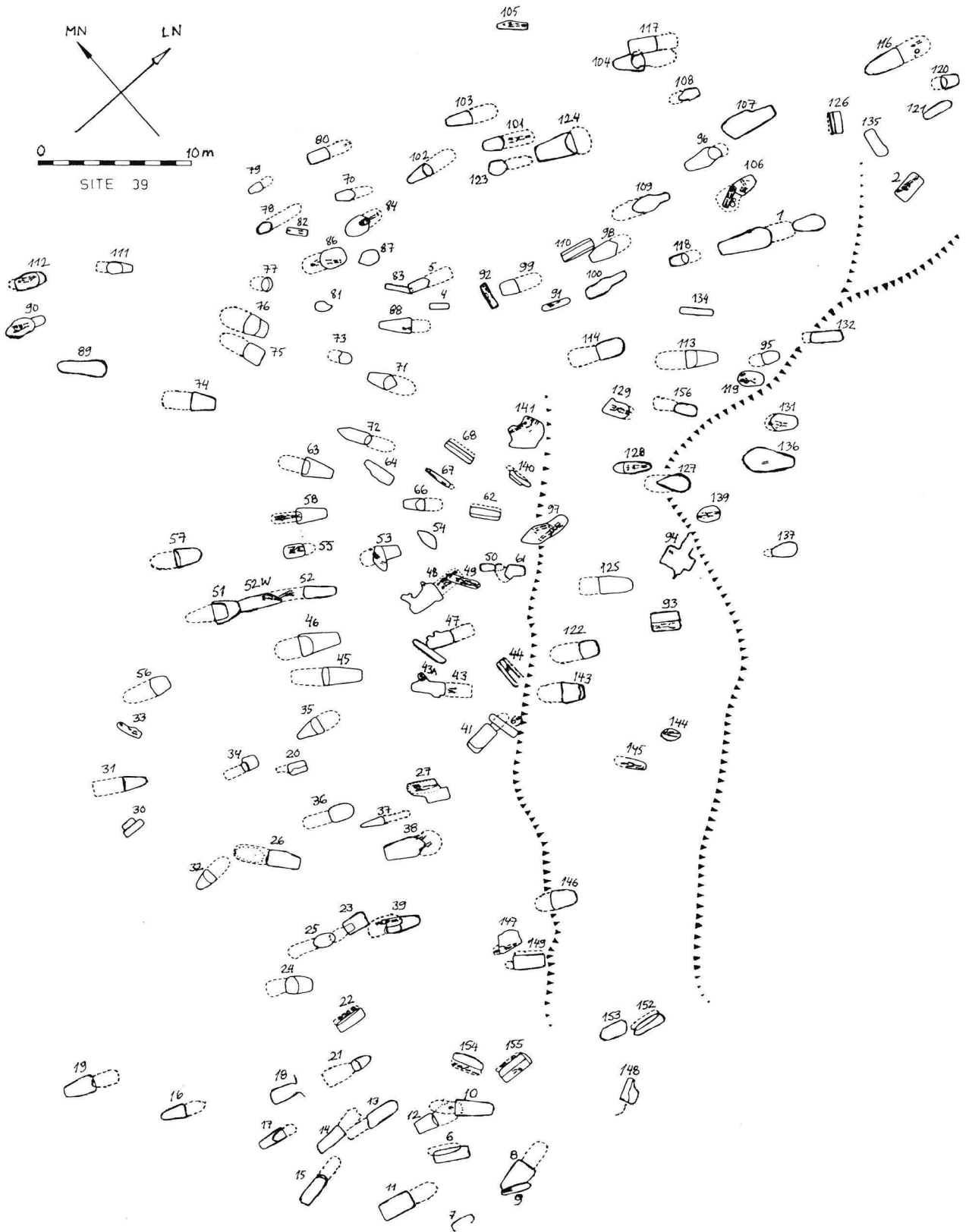

129. Site 39. Plan.

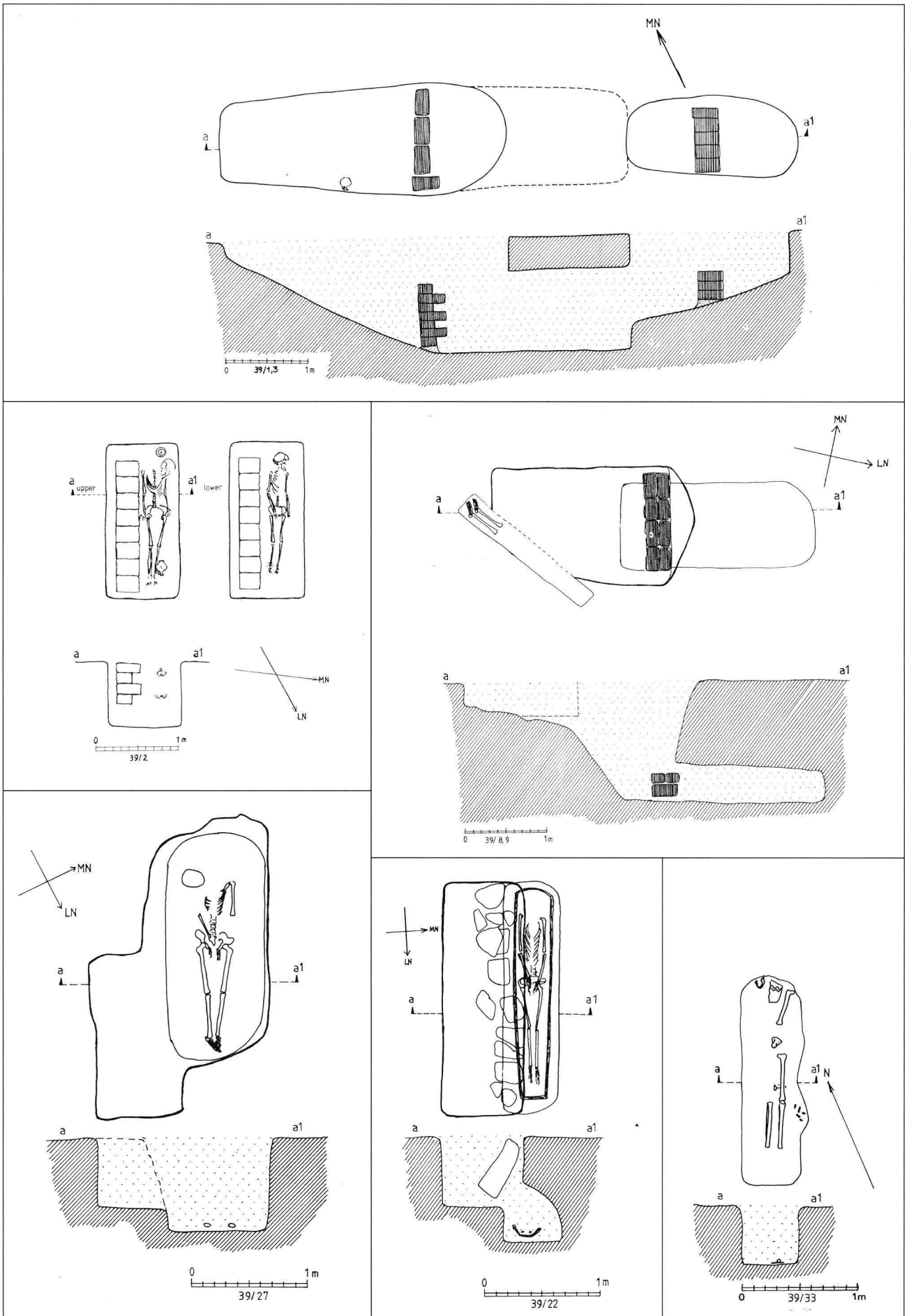

130. Site 39/1,2,3,8,9,22,27,33.

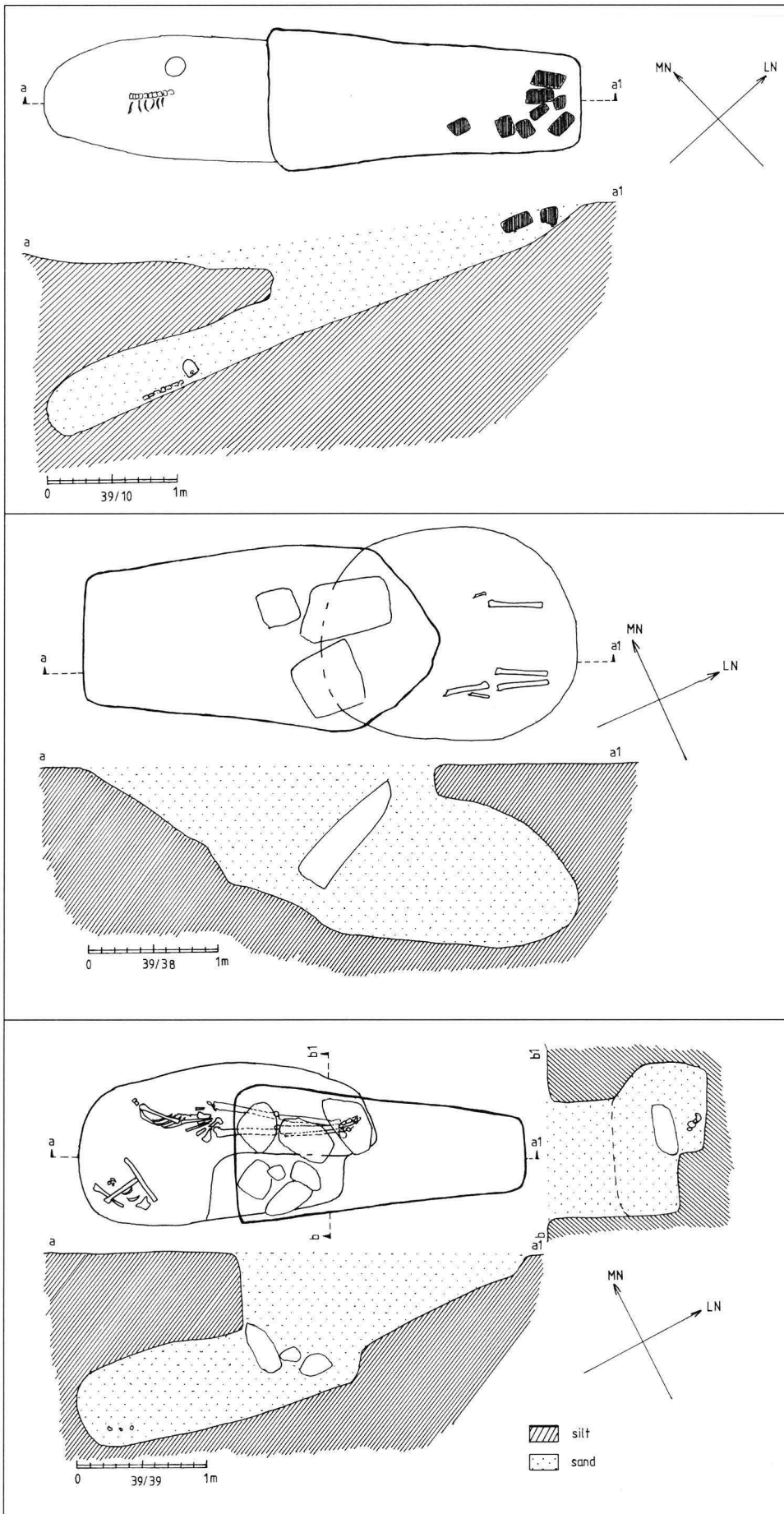

131. Site 39/10,38,39.

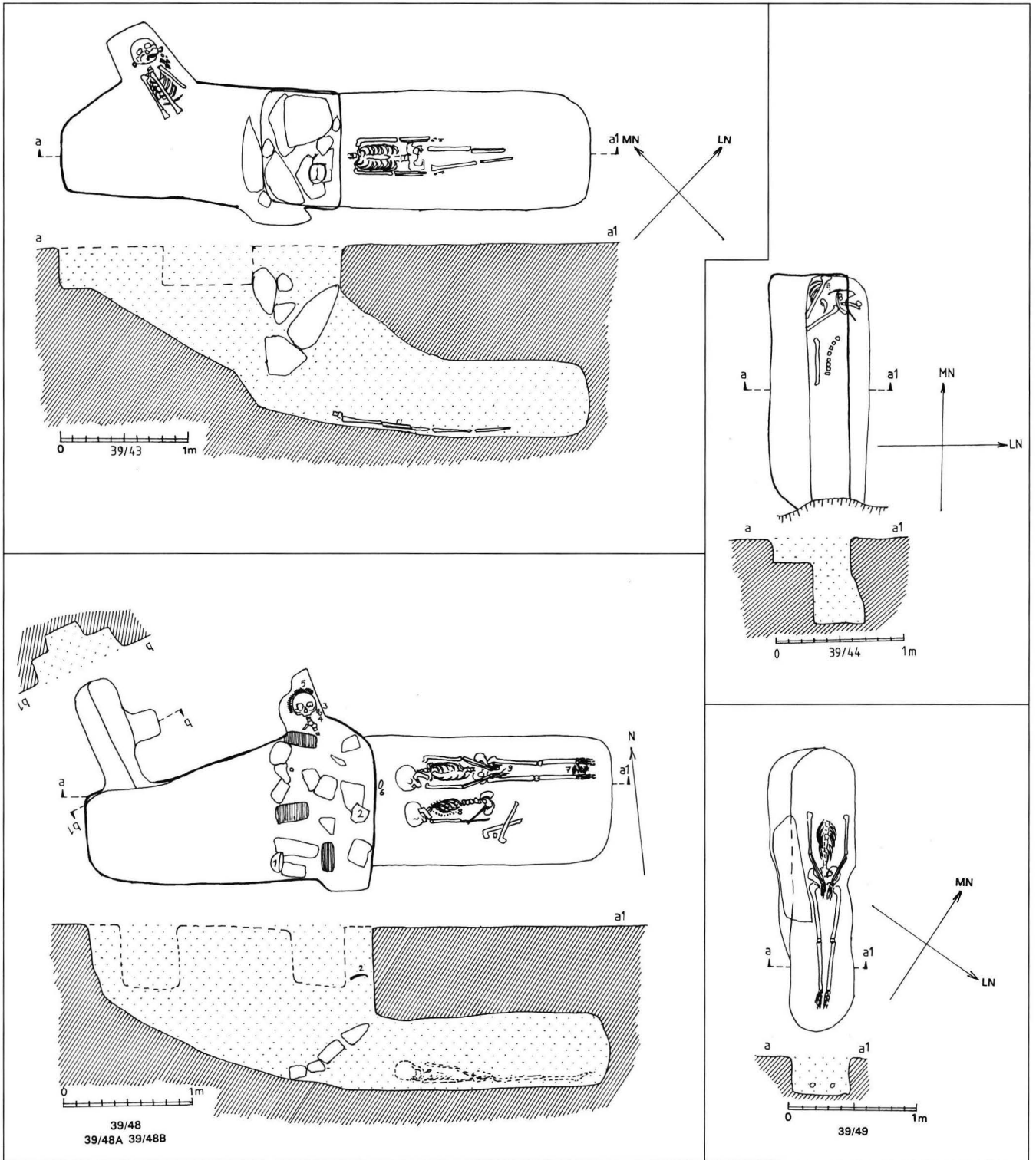

132. Site 39/43,44,48,48A,48B,49.

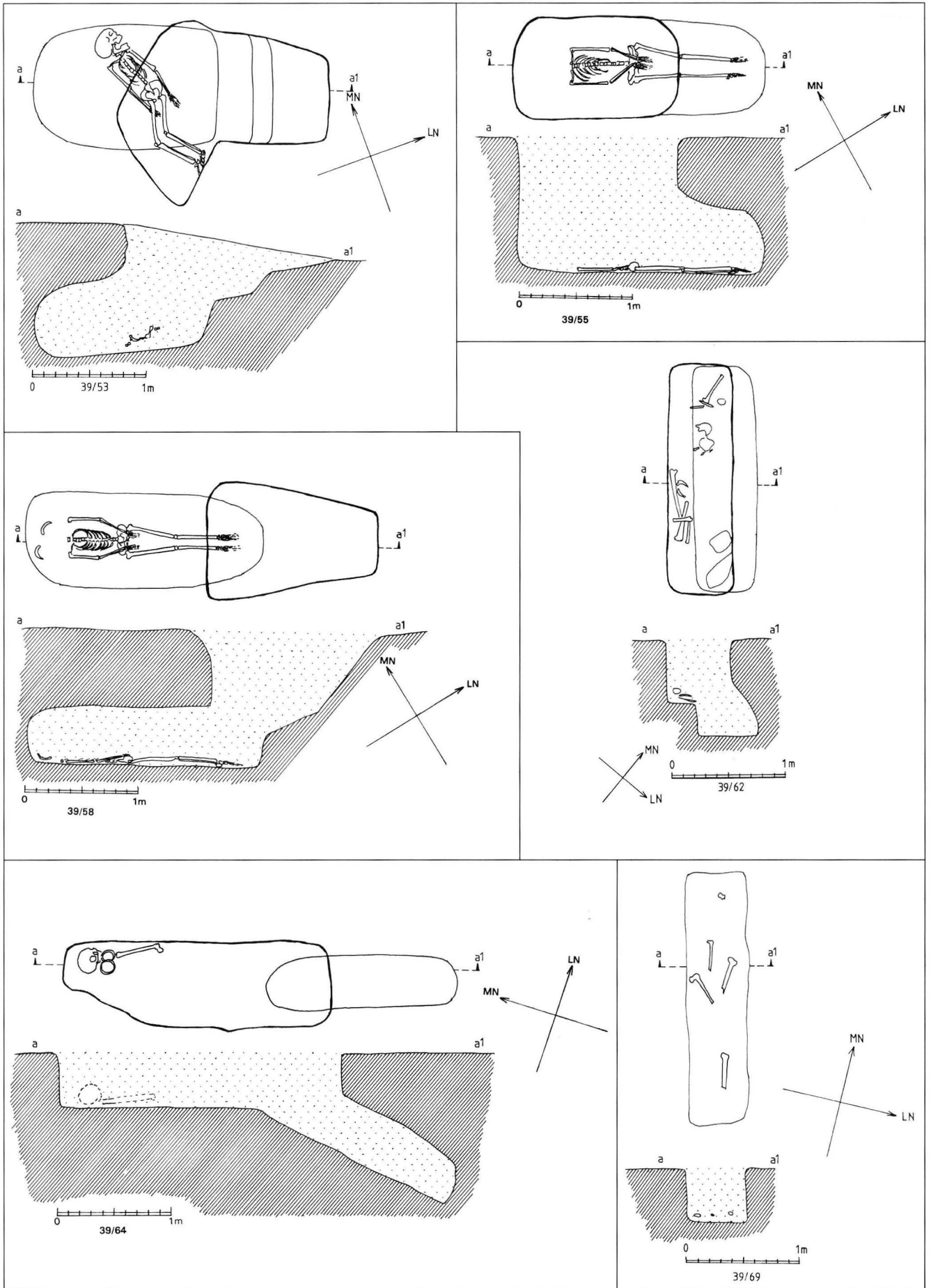

133. Site 39/53,55,58,62,64,69.

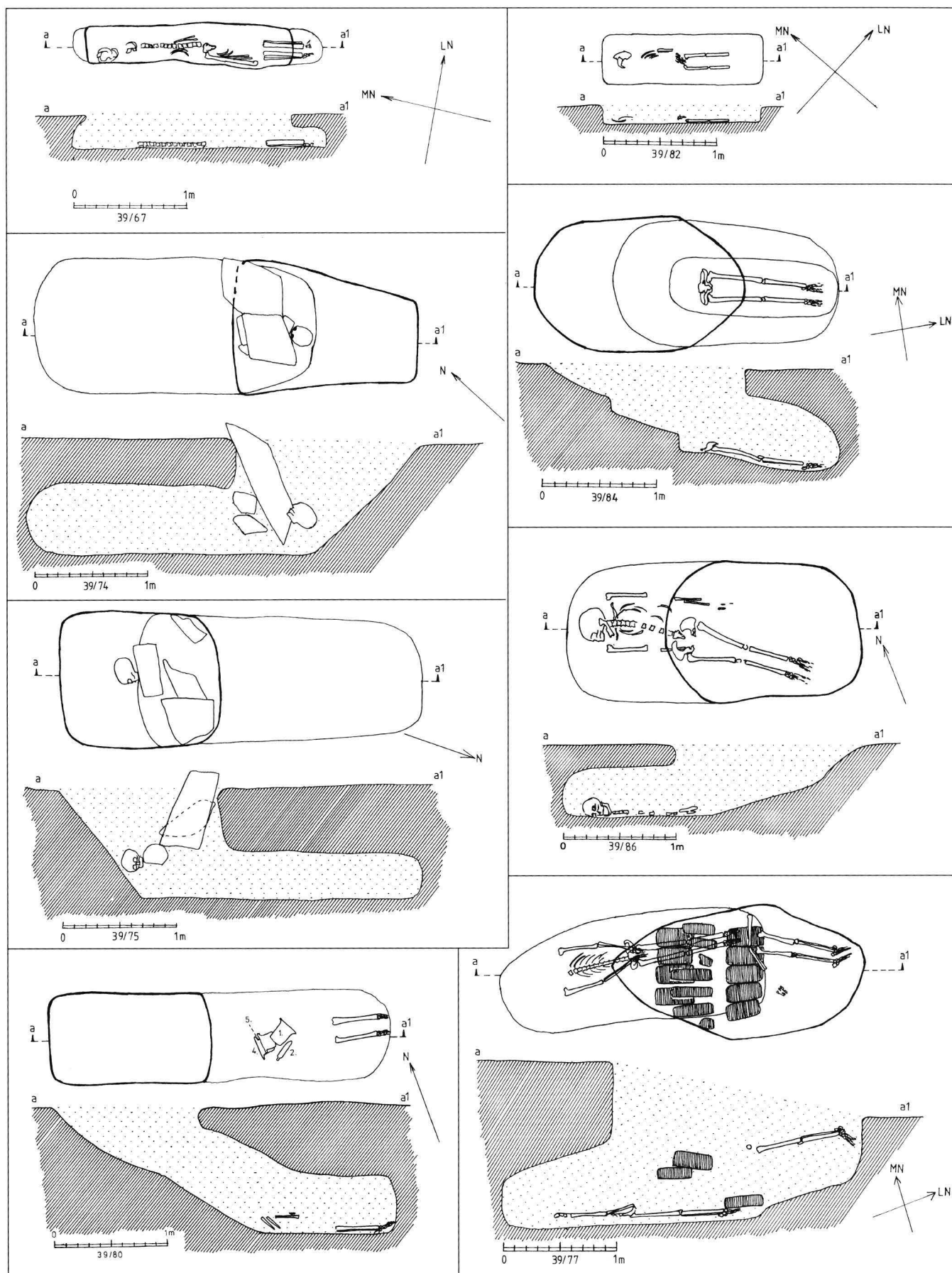

134. Site 39/67,74,75,77,80,82,84,86.

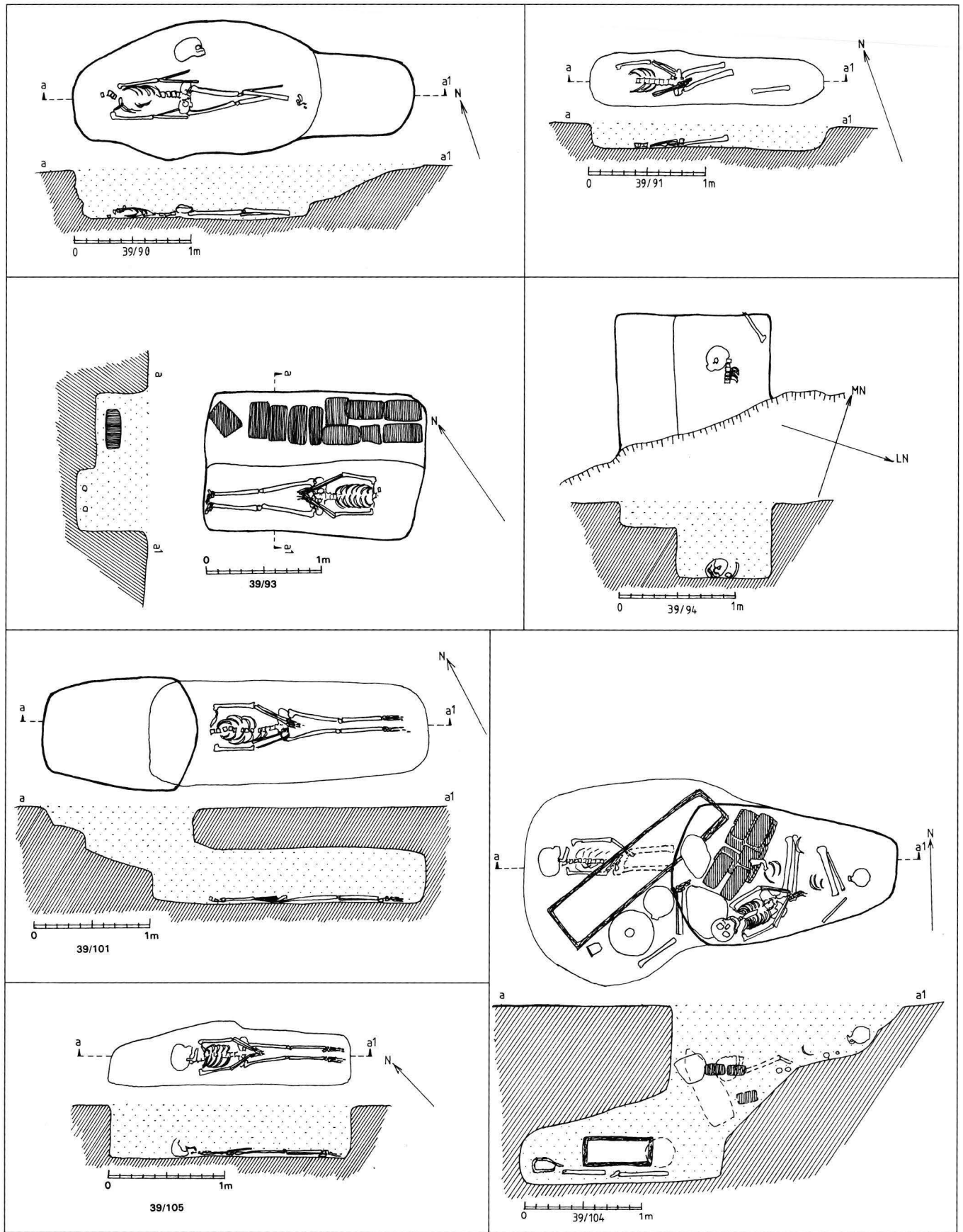

135. Site 39/90,91,93,94,101,104,105.

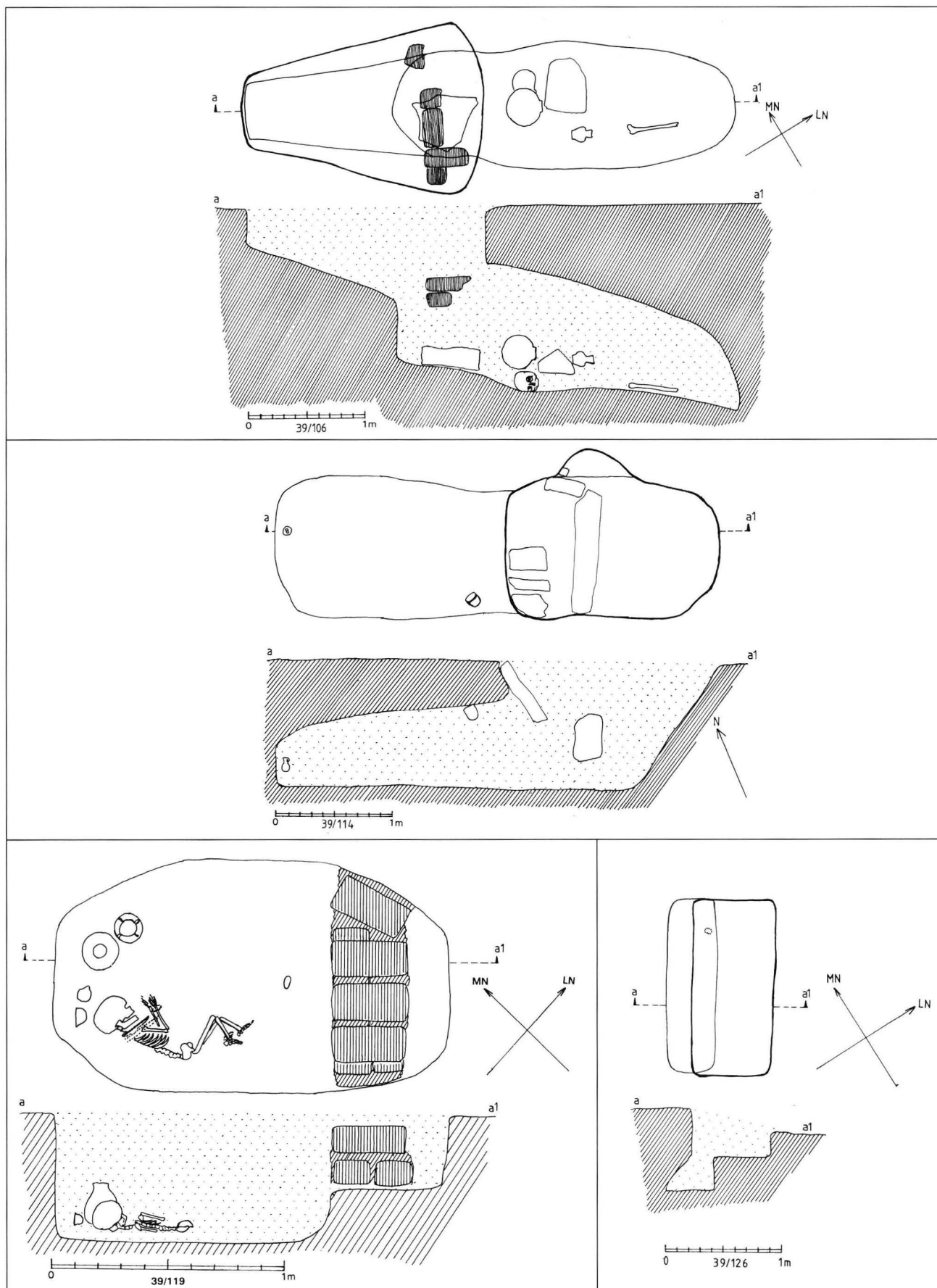

136. Site 39/106,114,119,126.

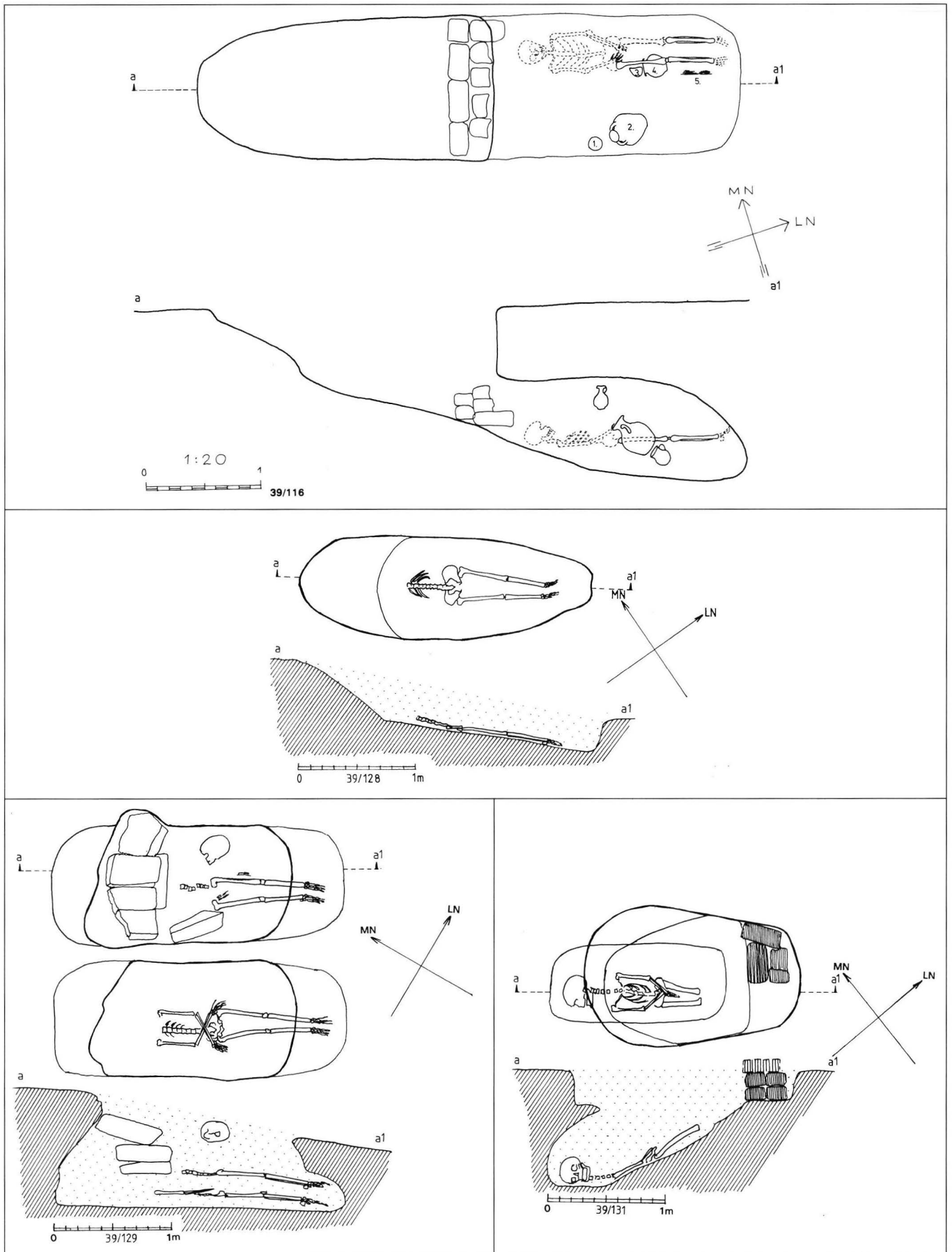

137. Site 39/116,128,129,131.

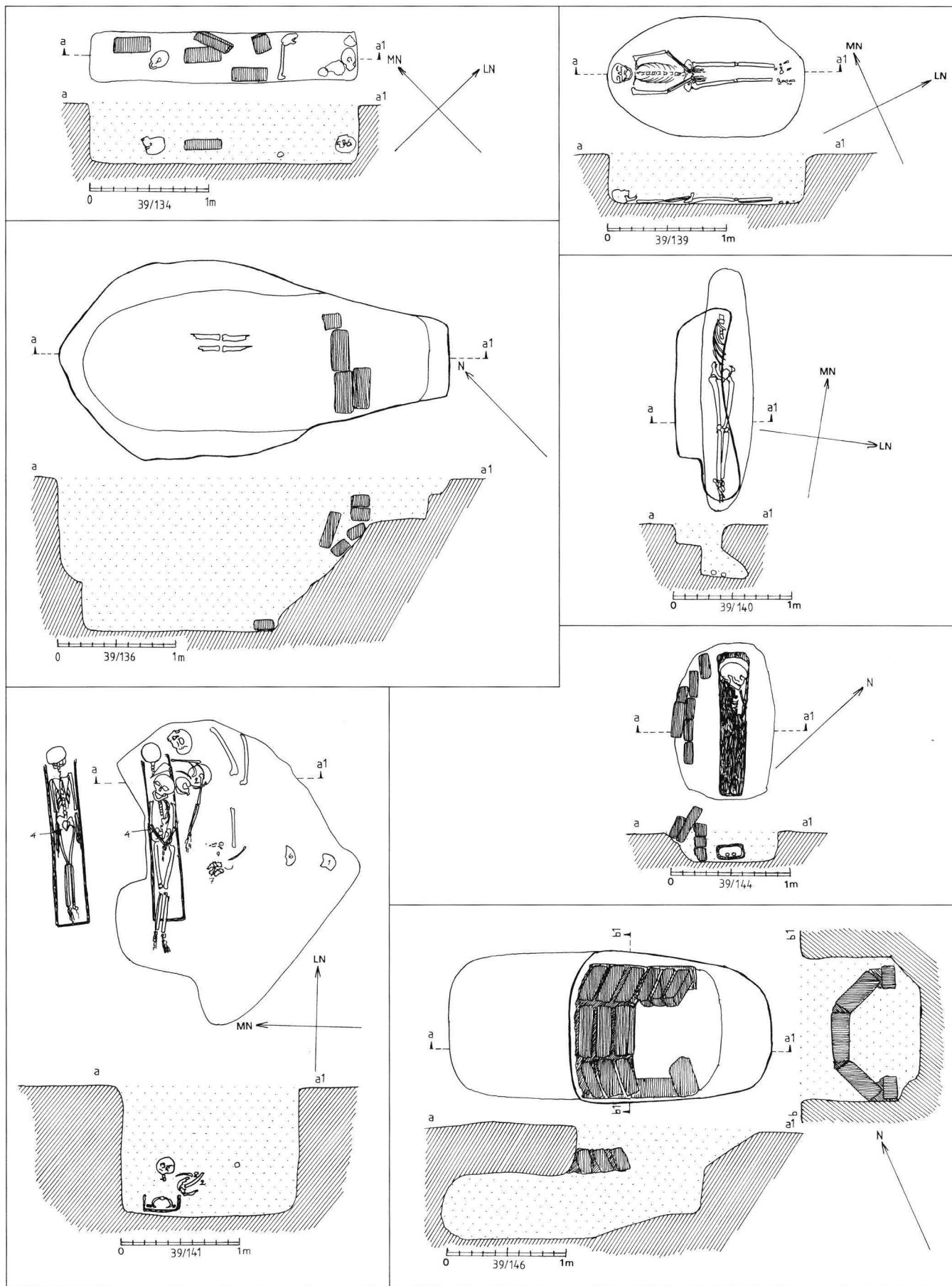

138. Site 39/134,136,139-141,144,146.

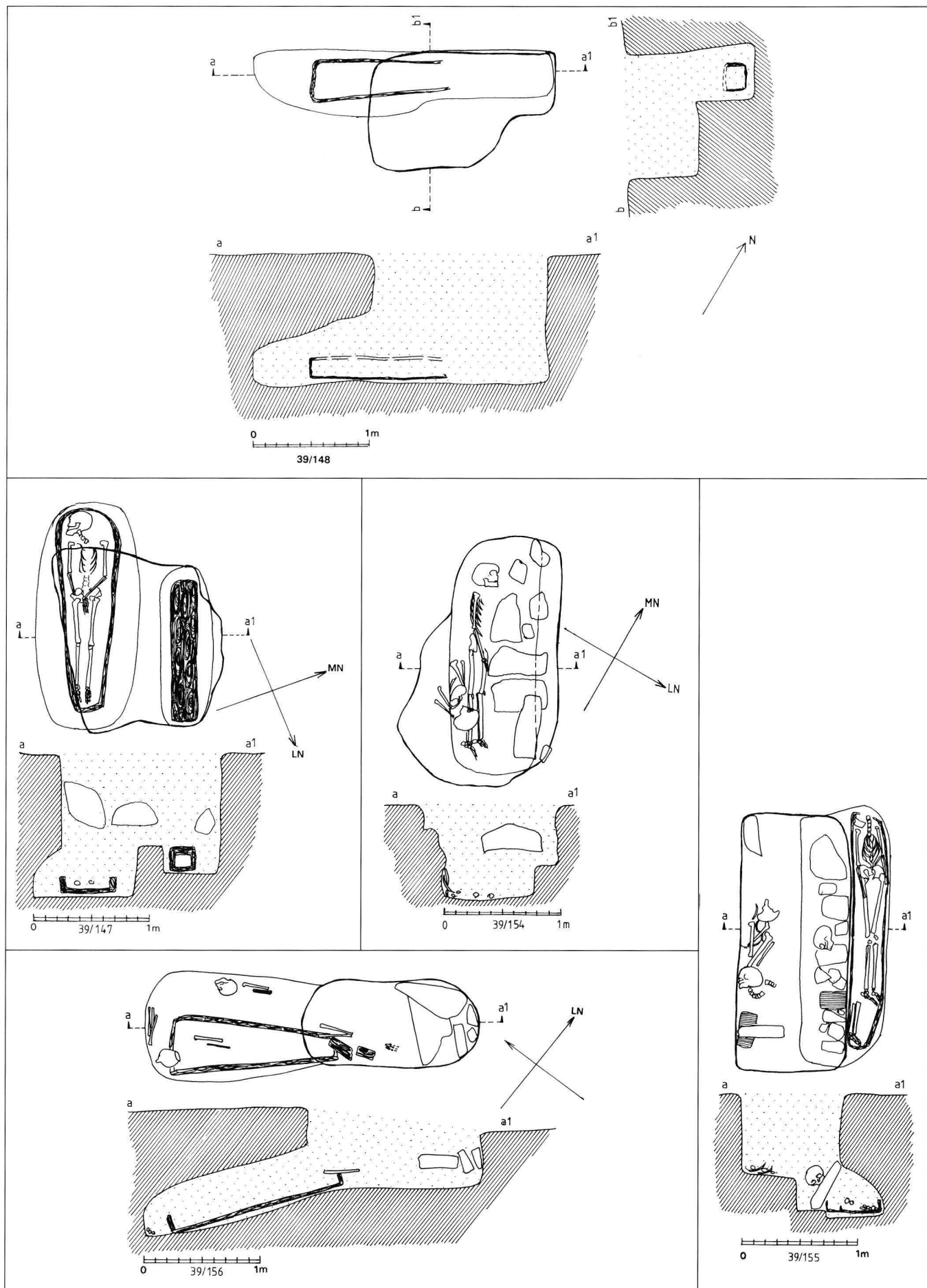

139. Site 39/147, 148, 154–156.



140. Site 40. Plan.

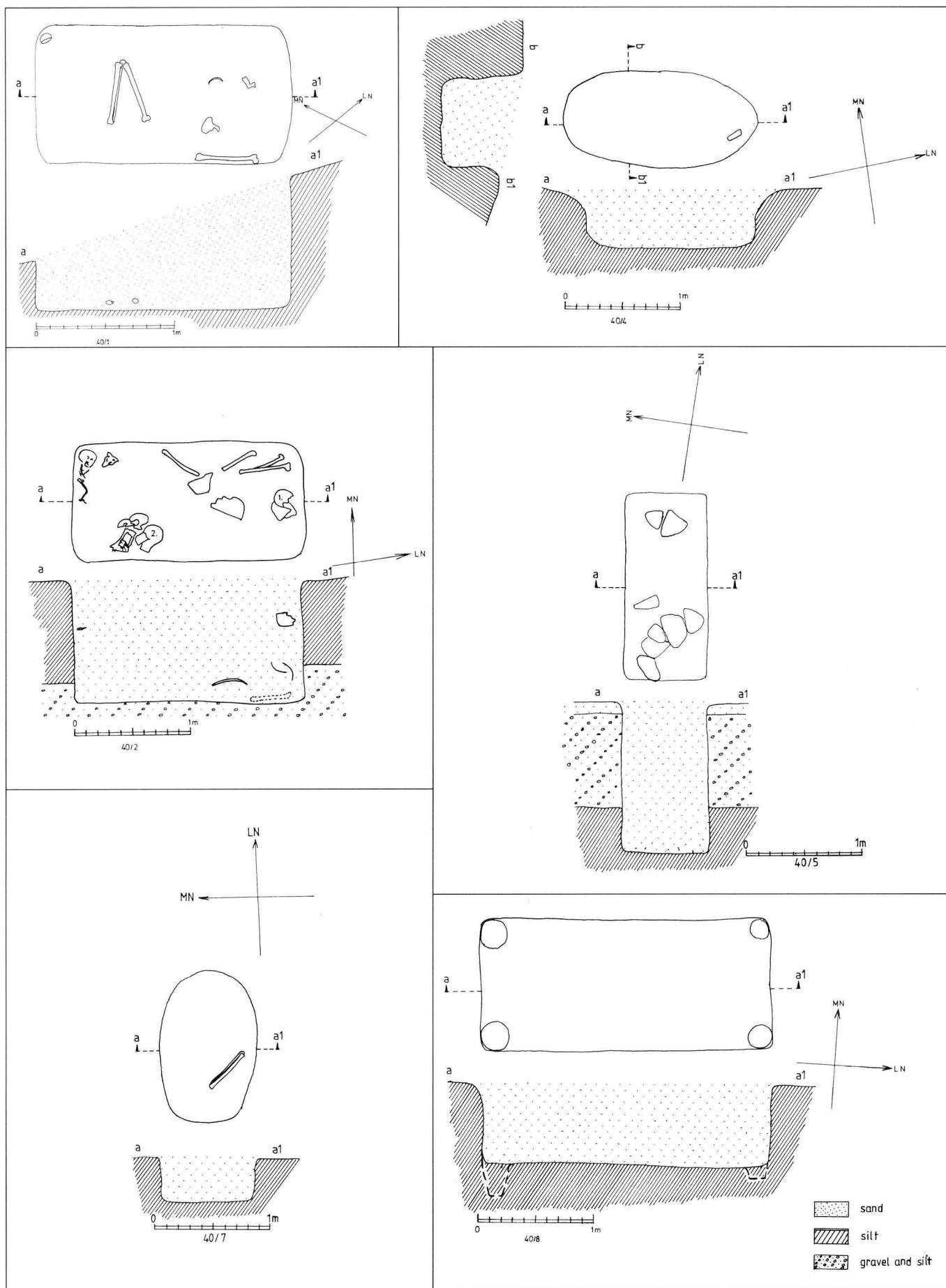

141. Site 40/1,2,4,5,7,8.

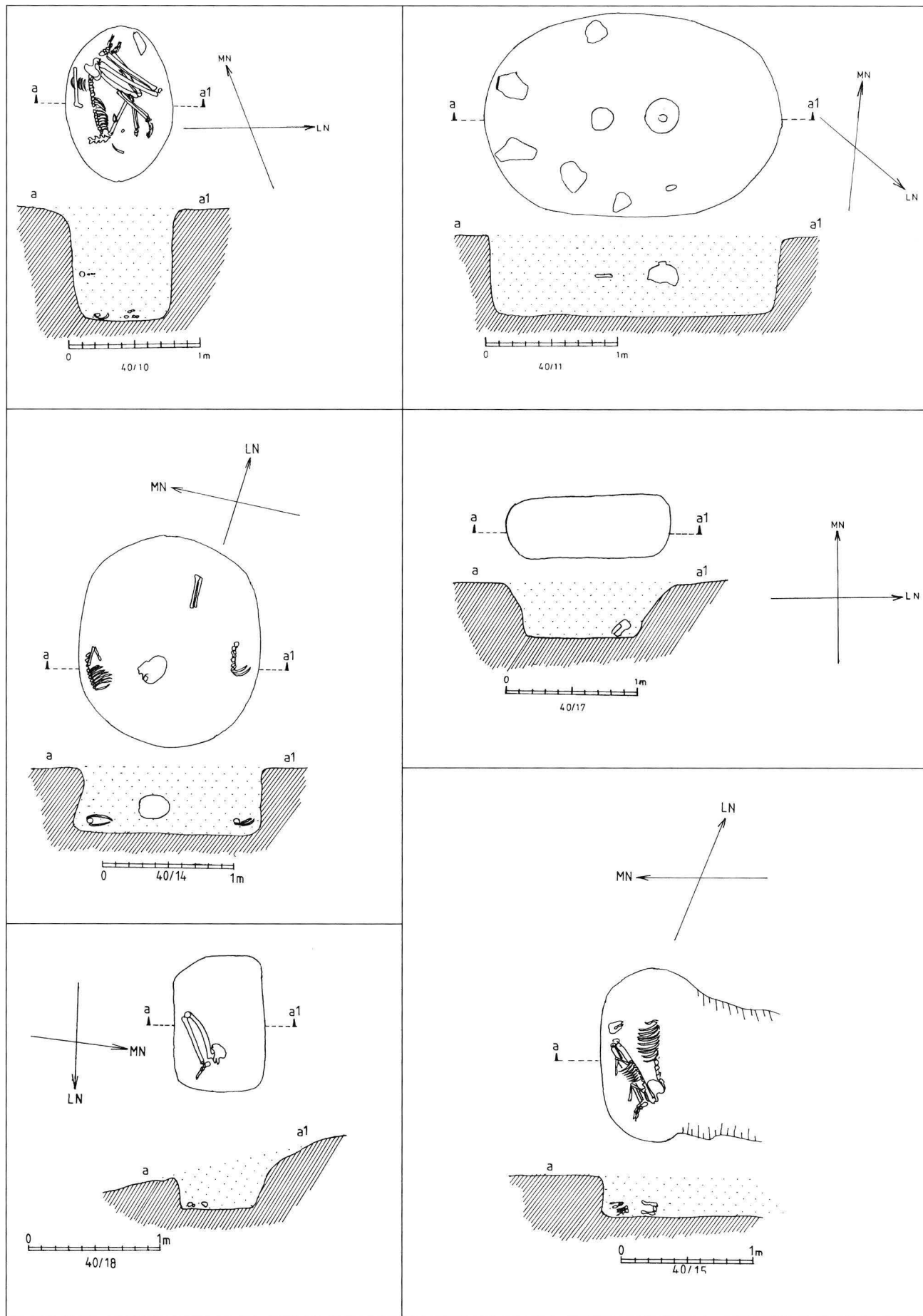

142. Site 40/10,11,14,15,17,18.

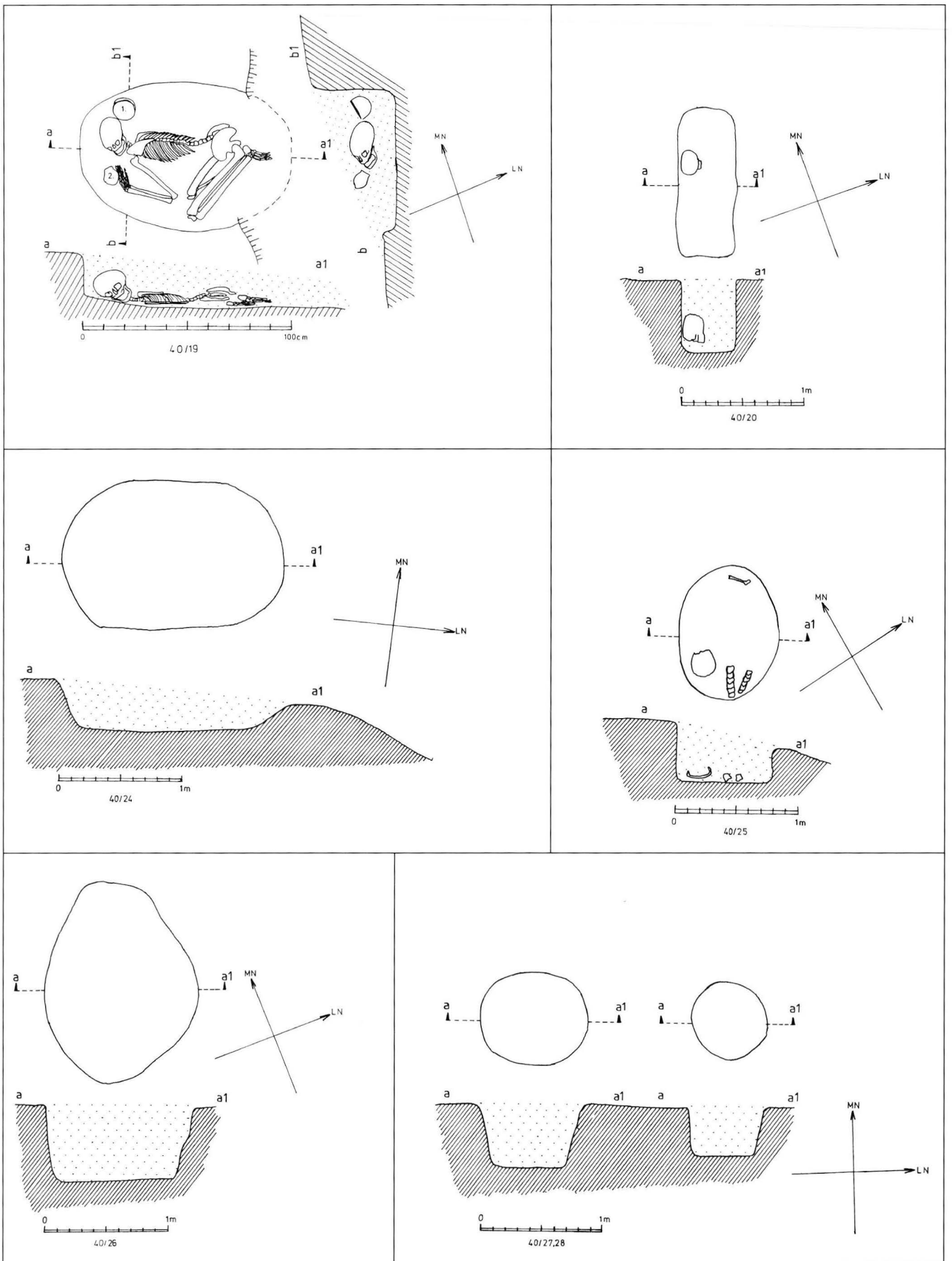

143. Site 40/19,20,24-28.

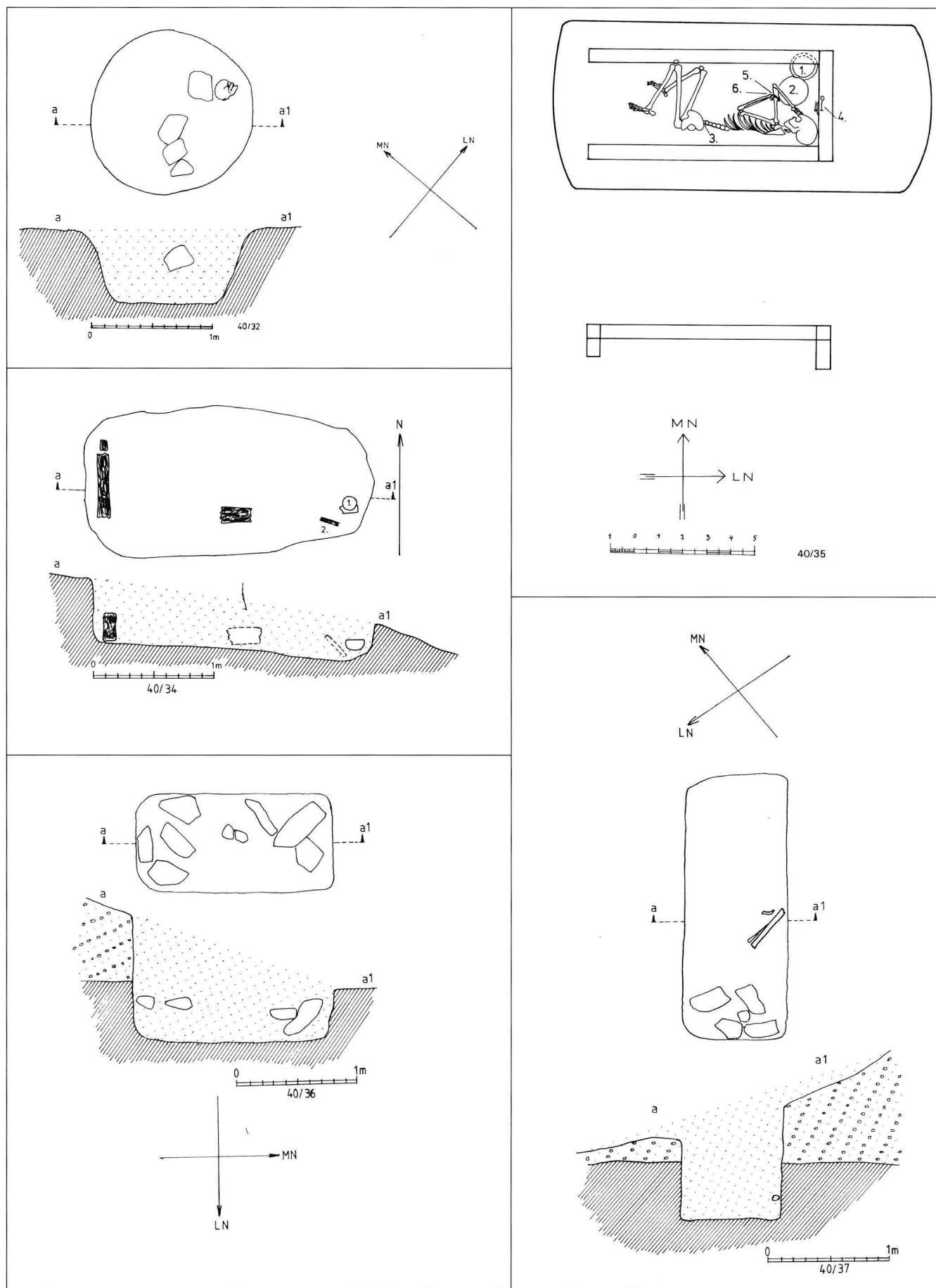

144. Site 40/32,34-37.



1.



2.



3.

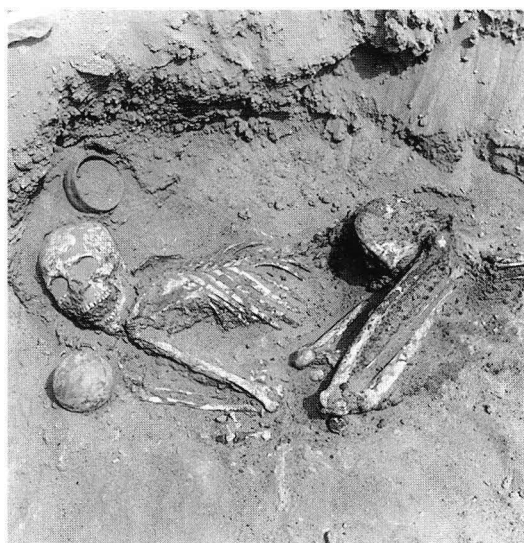

4.



5.



6.

145. 1. Site 40, under excavation, from W. 2. Body in the shaft (40/35). 3. Disturbed burial (40/14). 4. Body in the shaft (40/19). 5-6. Sealing and a (child) body in the shaft (40/2).

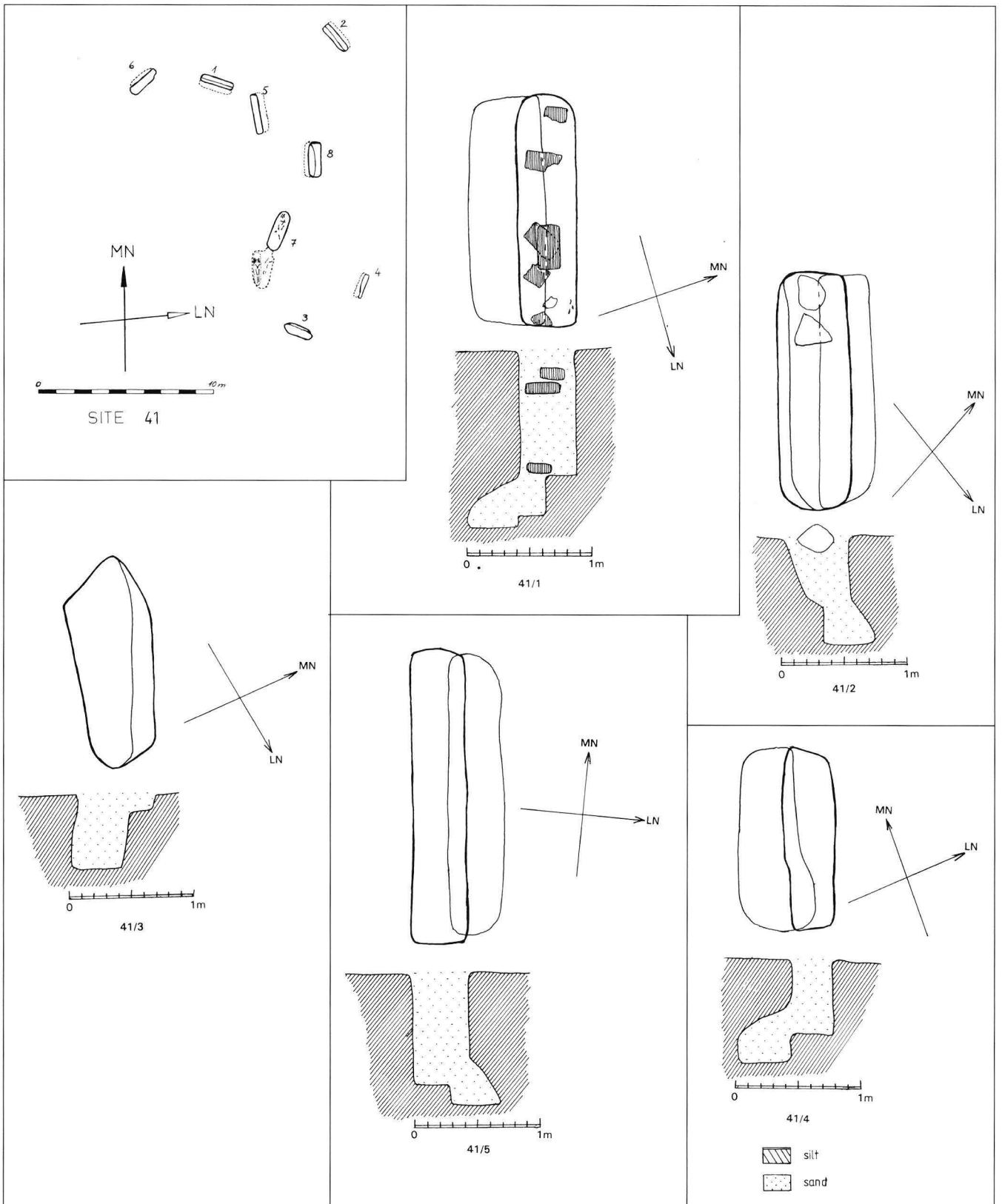

146. Site 41. Plan. 41/1-5.

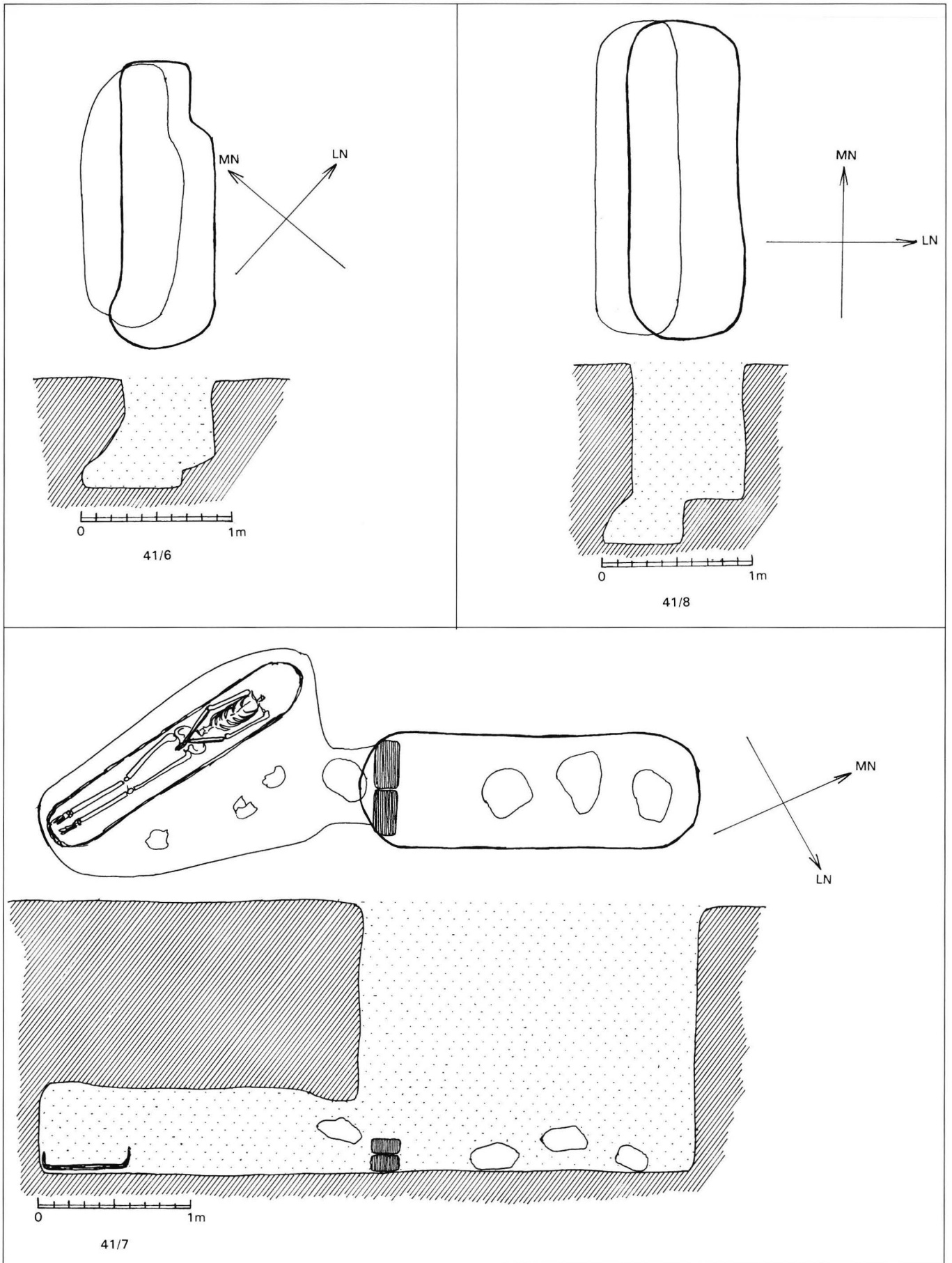

147. Site 41/6-8.

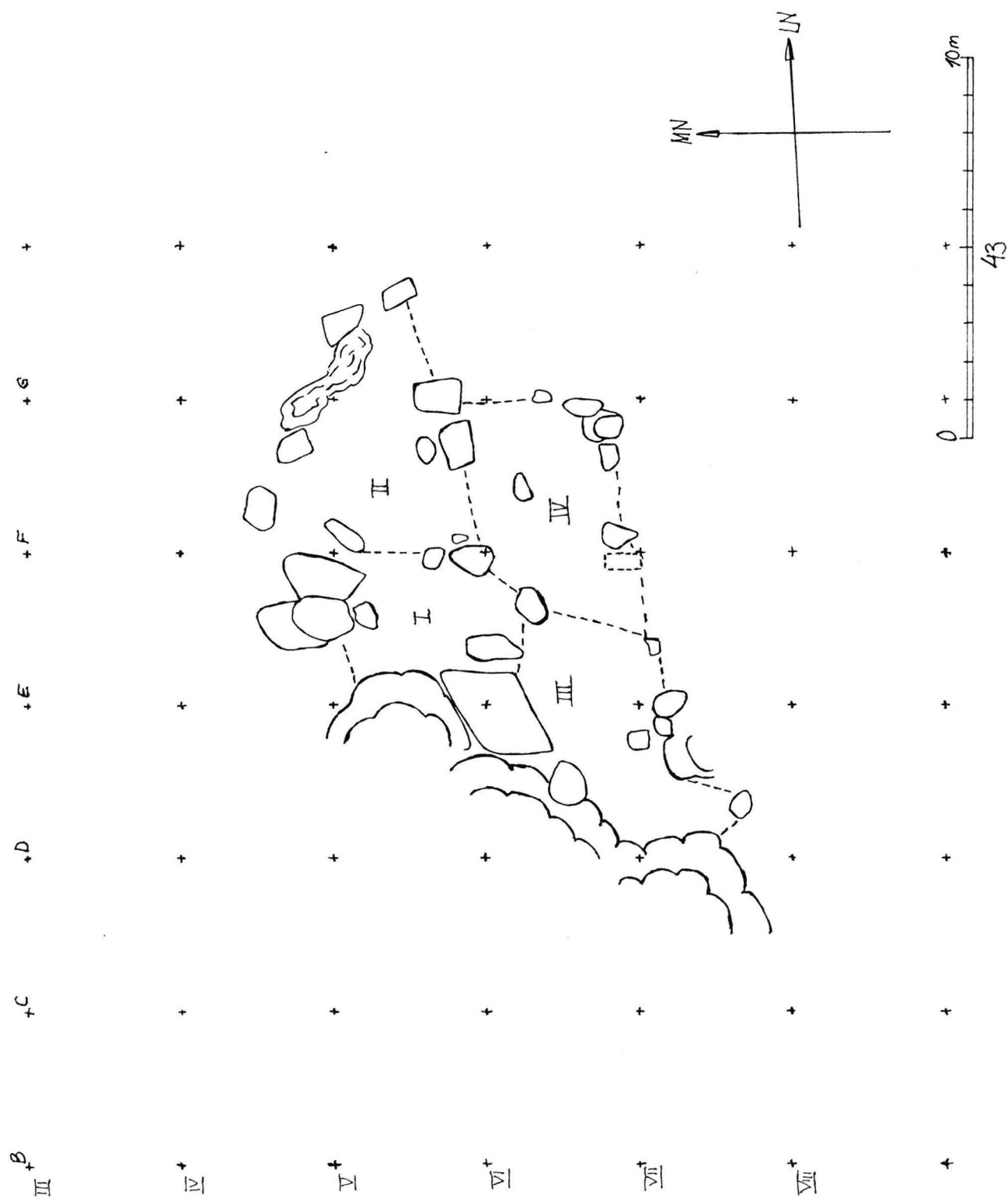

148. Site 43. Plan.

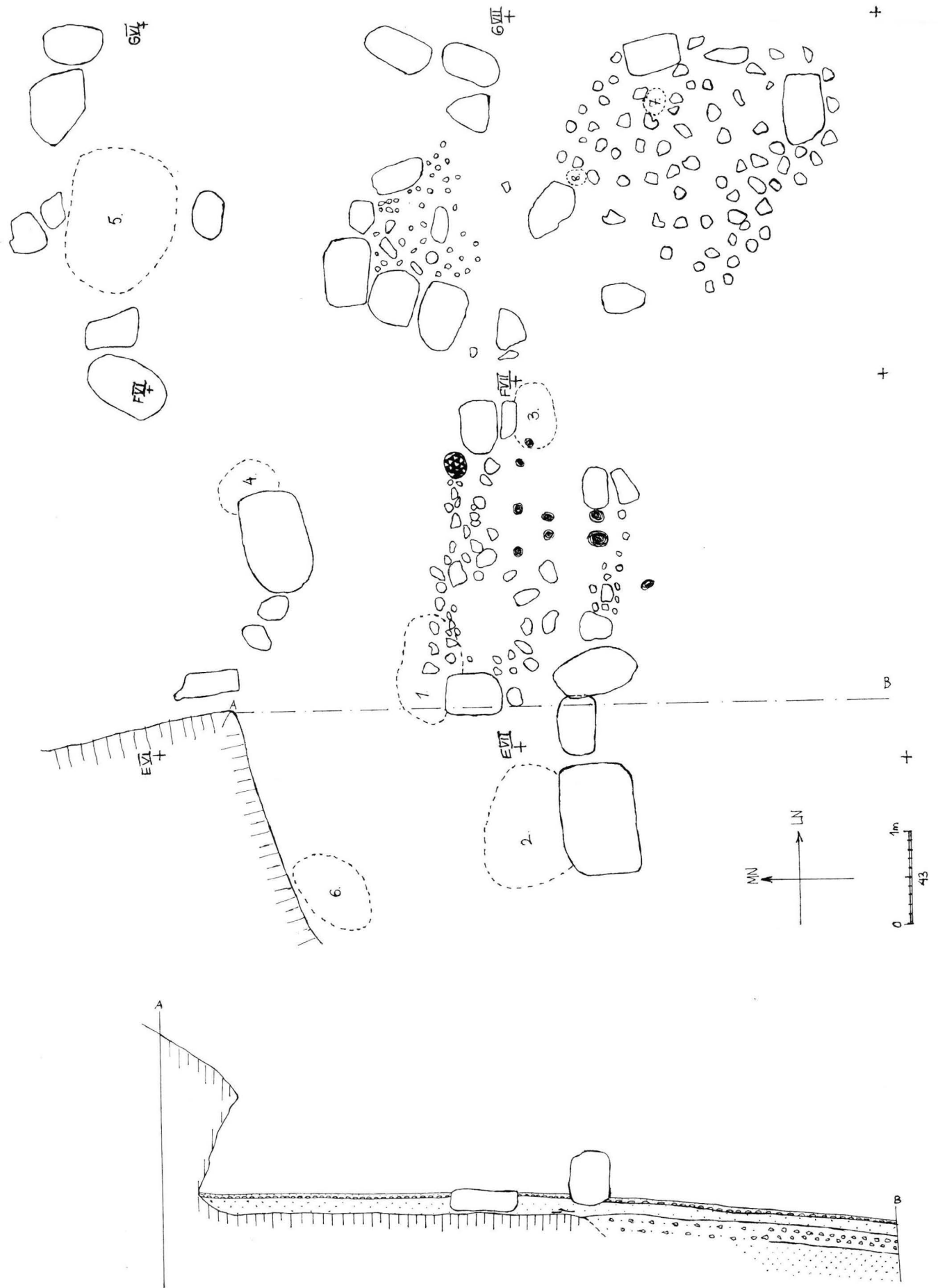

149. Site 43. Find groups 1-6.



1.



2.



3.



4.

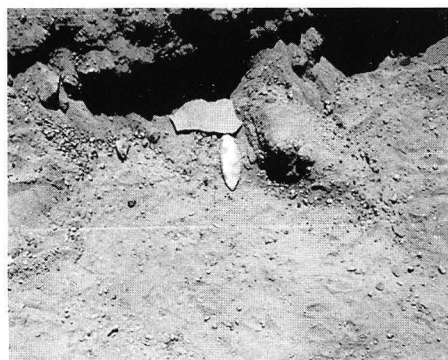

5.

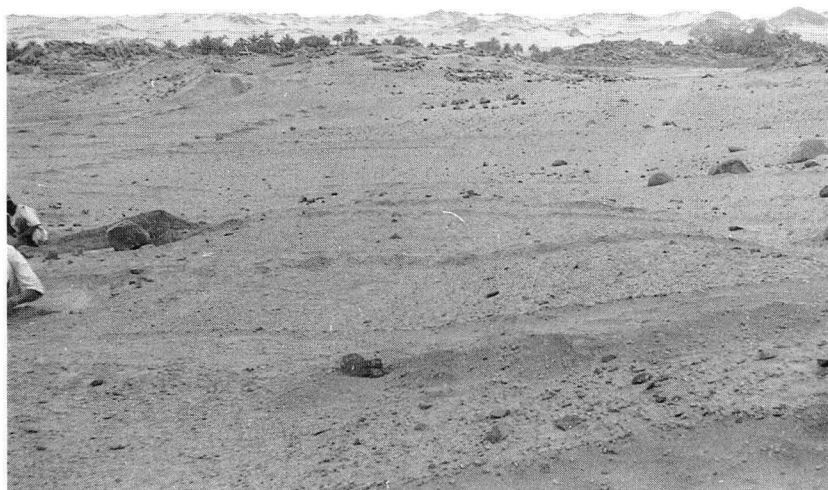

6.

150. 1. Survey of the site 41. 2. Site 42, from N. 3. Site 43, under excavation. 4. Old silt bank SE of the site 43. 5. Knife in situ (43/EVI). 6. Site 44, from S.

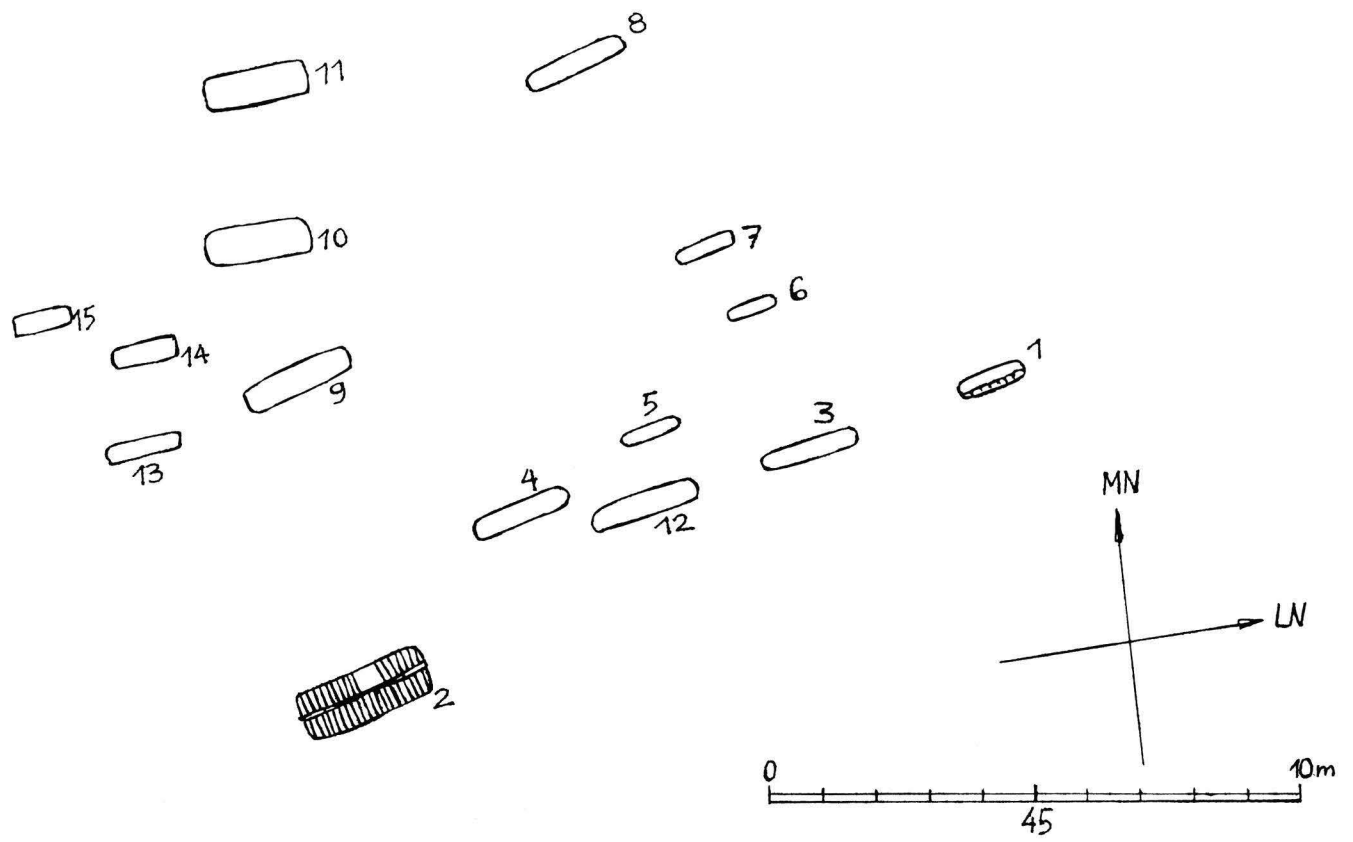

151. Site 45. Plan.

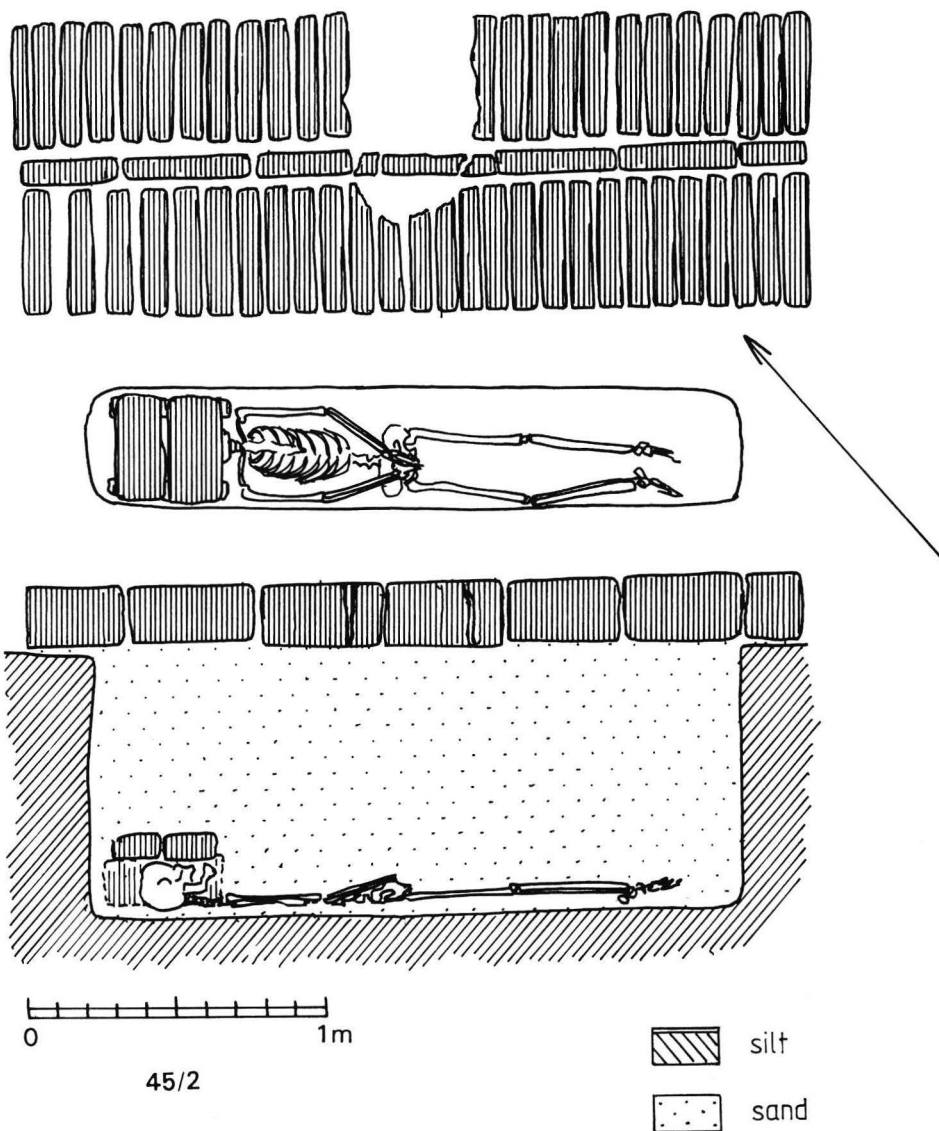
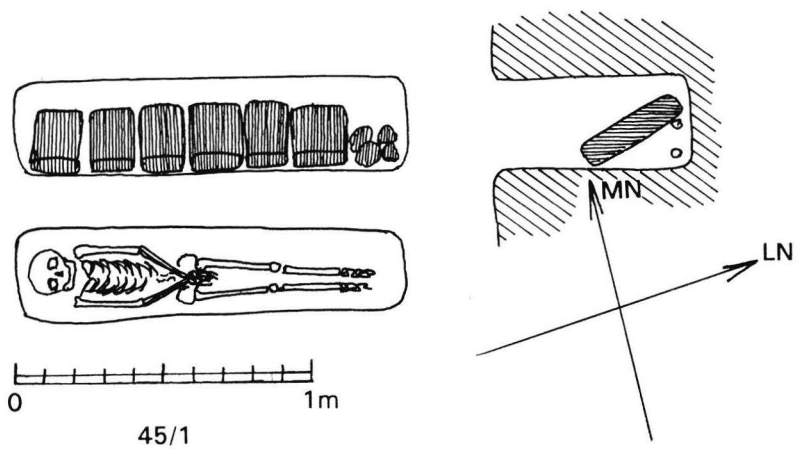



1.



2.



3.



4.



5.

153. 1-2. Sealing and a stone chist and a leatherwrap (44/3). 3. Site 45, from W. 4-5. Sealing and a body in the shaft (45/3).

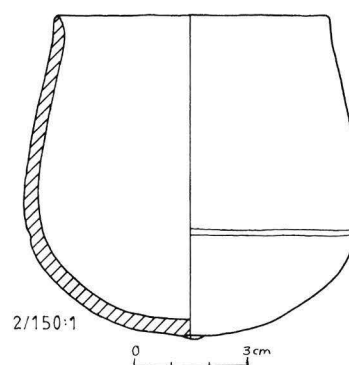
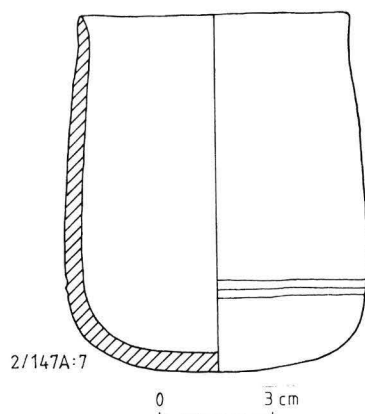
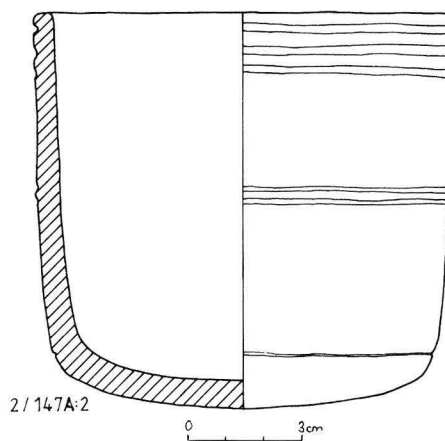
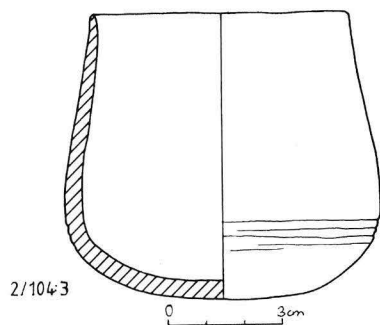
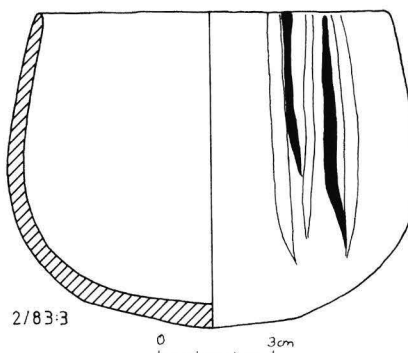
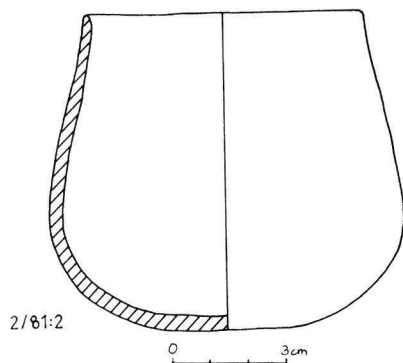
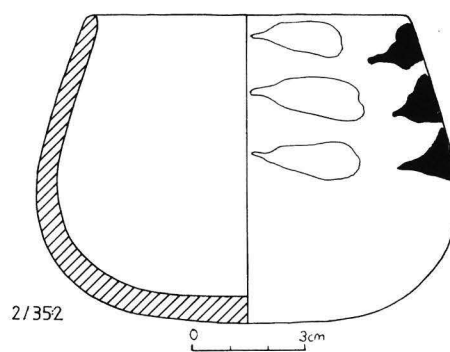
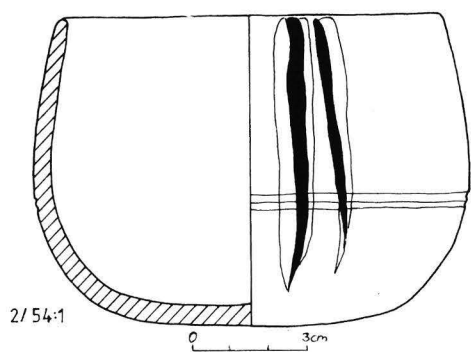

154. Site 2. Ceramic repertoire. **Cups:** Classic X-group red ware, *NII/RI*.

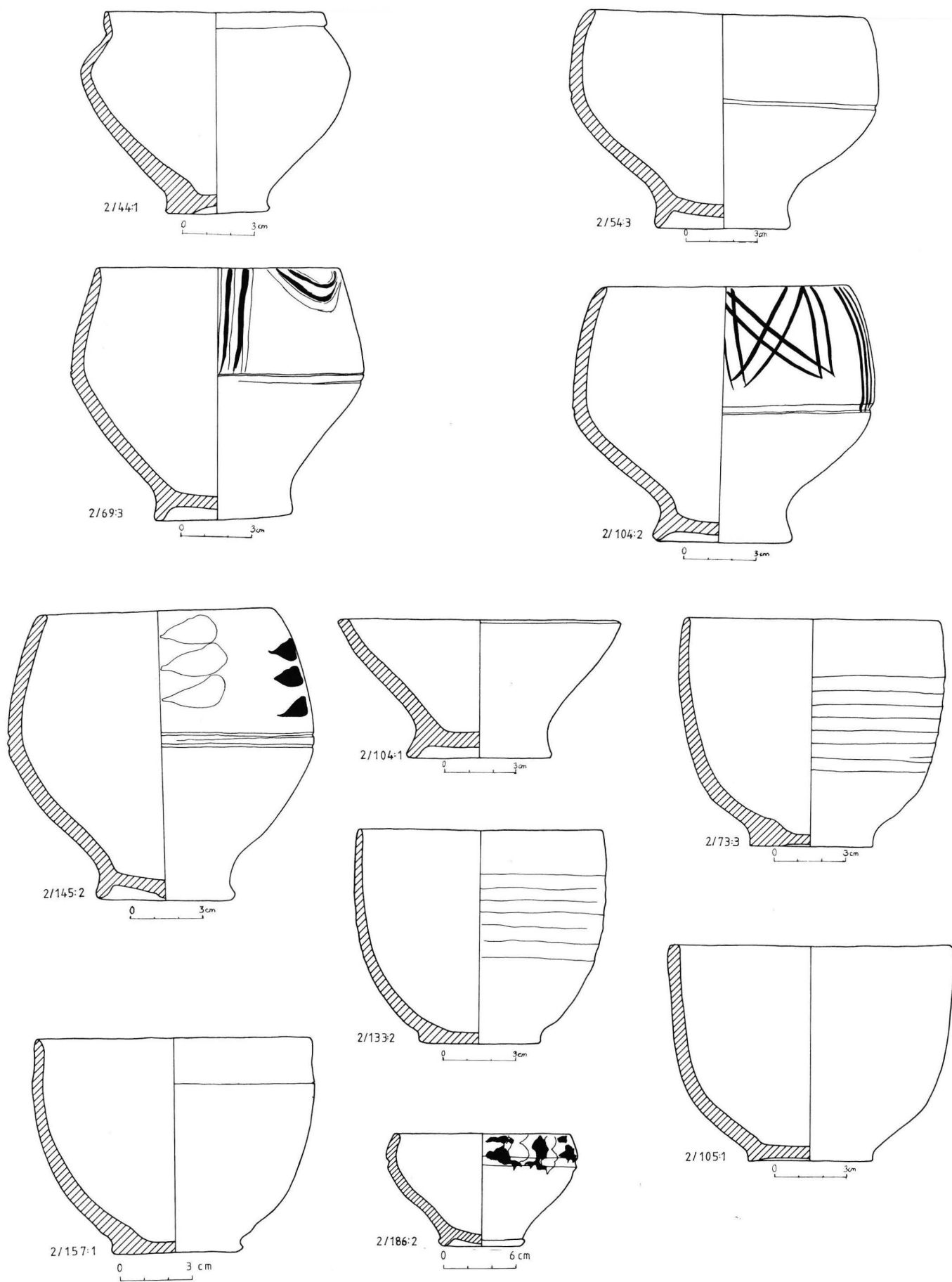

155. Site 2. Ceramic repertoire. **Goblets:** Classic X-group red ware, *NII/R1*, nos. 44:1,54:3,69:3;104:1,2;145:2. Early X-group brown ware, Egyptian made specimen, *T/R25*, nos. 73:3,105:1,133:2,157:1. Aswan Graeco-Roman ordinary red ware, *AI/R30*, no. 186:2.

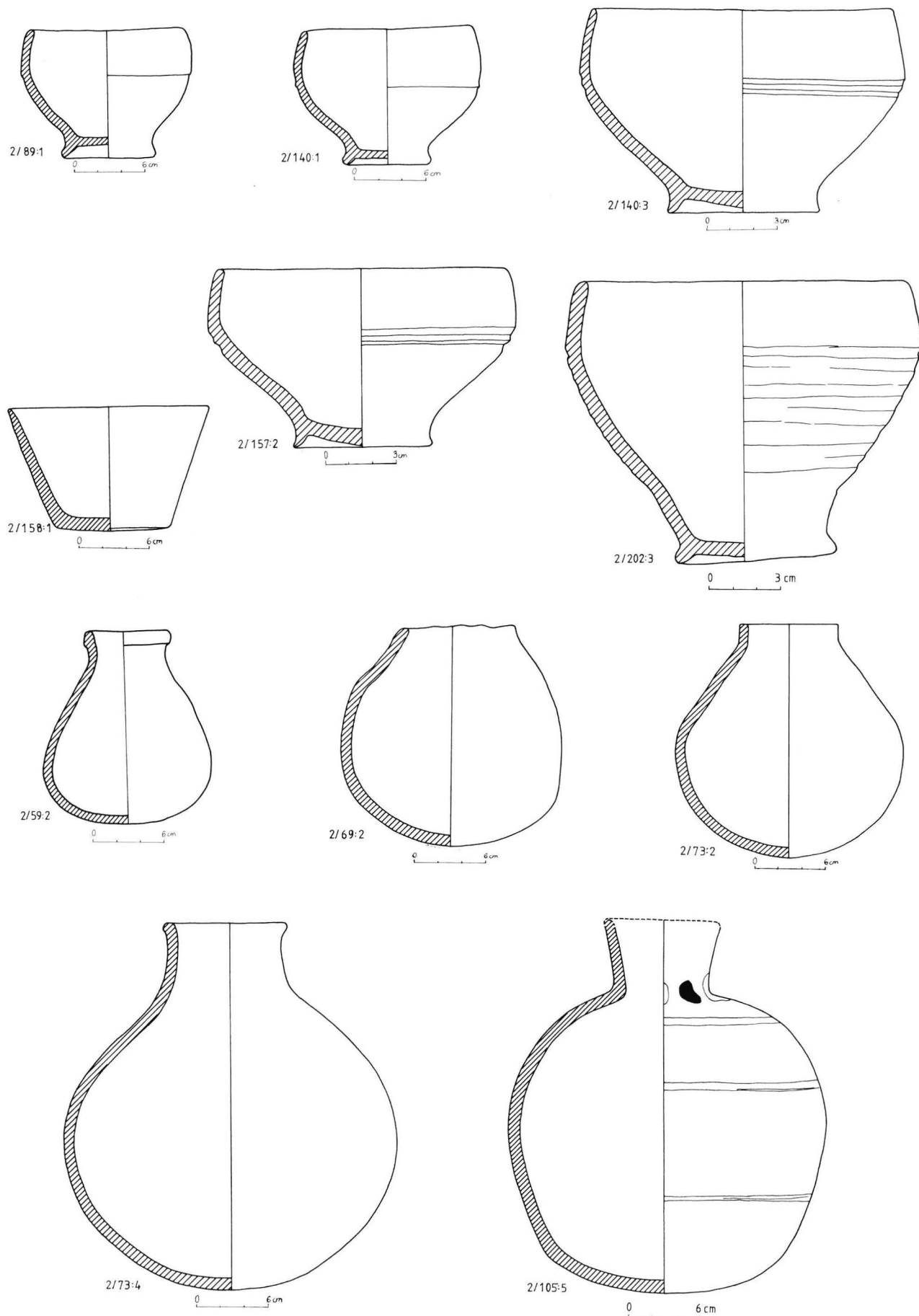

156. Site 2. Ceramic repertoire. **Footed bowls:** Classic X-group red ware, *NII/RI*, nos. 89:1;140:1,3;157:2,202:3. **Bowl 158:1.** **Pots:** Early Christ. brown utility ware, *NU/UI*, no. 59:2. Early domestic plain utility ware, *DI/HI*, no. 69:2. *DI* or *DII/HI*, nos. 73:2,4. Transitional red ware, *NII/R2*, no. 105:5.

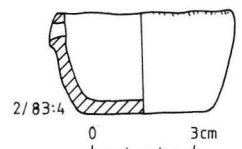
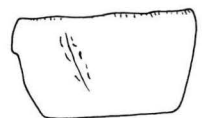
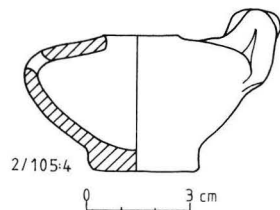
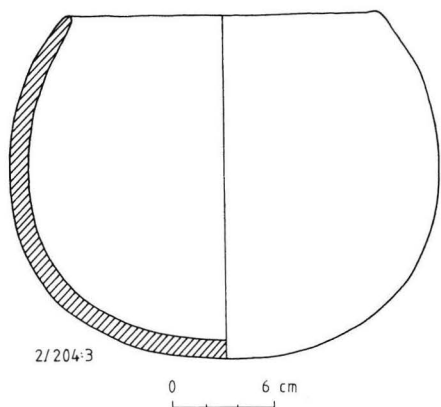
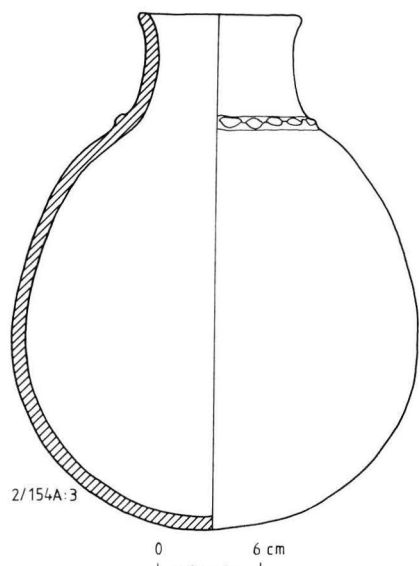
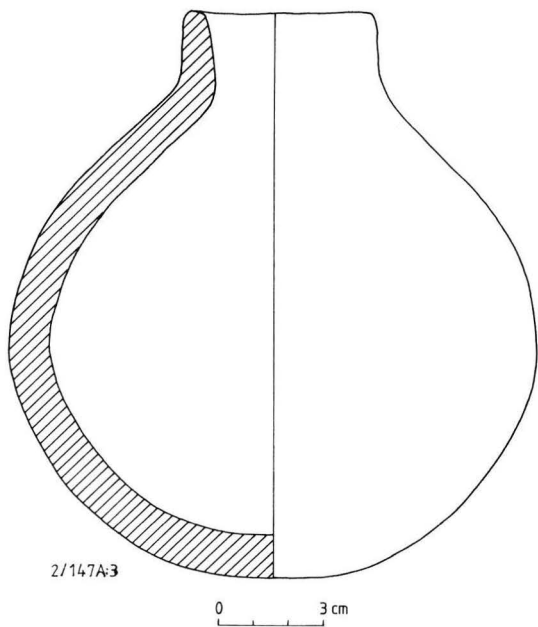
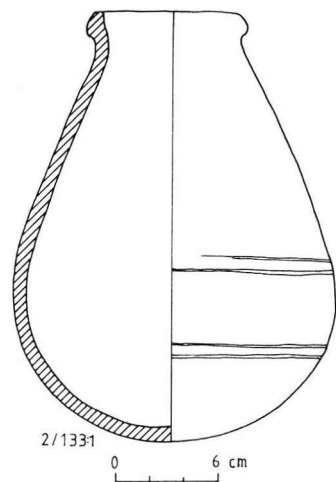
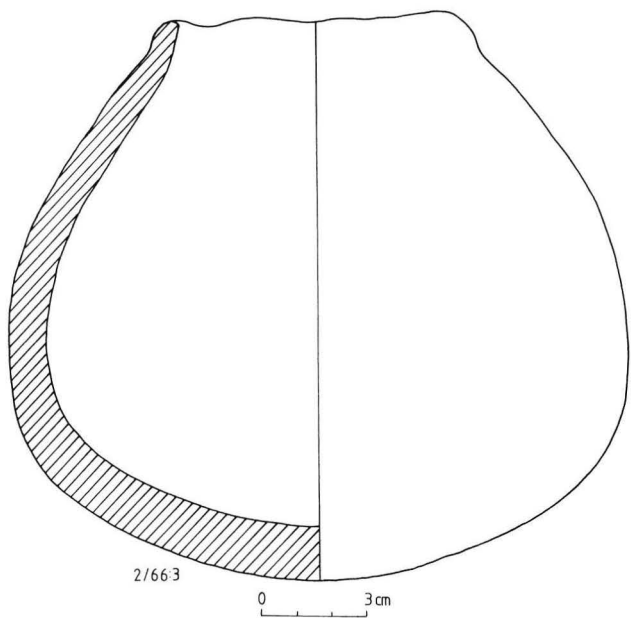

157. Site 2. Ceramic repertoire. **Pots:** Earlier Christ. red-topped domestic ware, *D1* and *DII/H2*, no. 66:3. Classic X-group red ware, *NII/RI*, no. 133:1. Early domestic plain utility ware, *DII/H1*, no. 147A:3. Earlier Christ. red domestic ware, *DII/H3*, no. 154A:3. Meroitic burnished domestic ware, *DII/H9*, no. 204:3. **Lamp:** Meroitic ordinary red ware, *NI/R32*, no. 105:4. **Beaker:** *D1/H1*, no. 83:4.

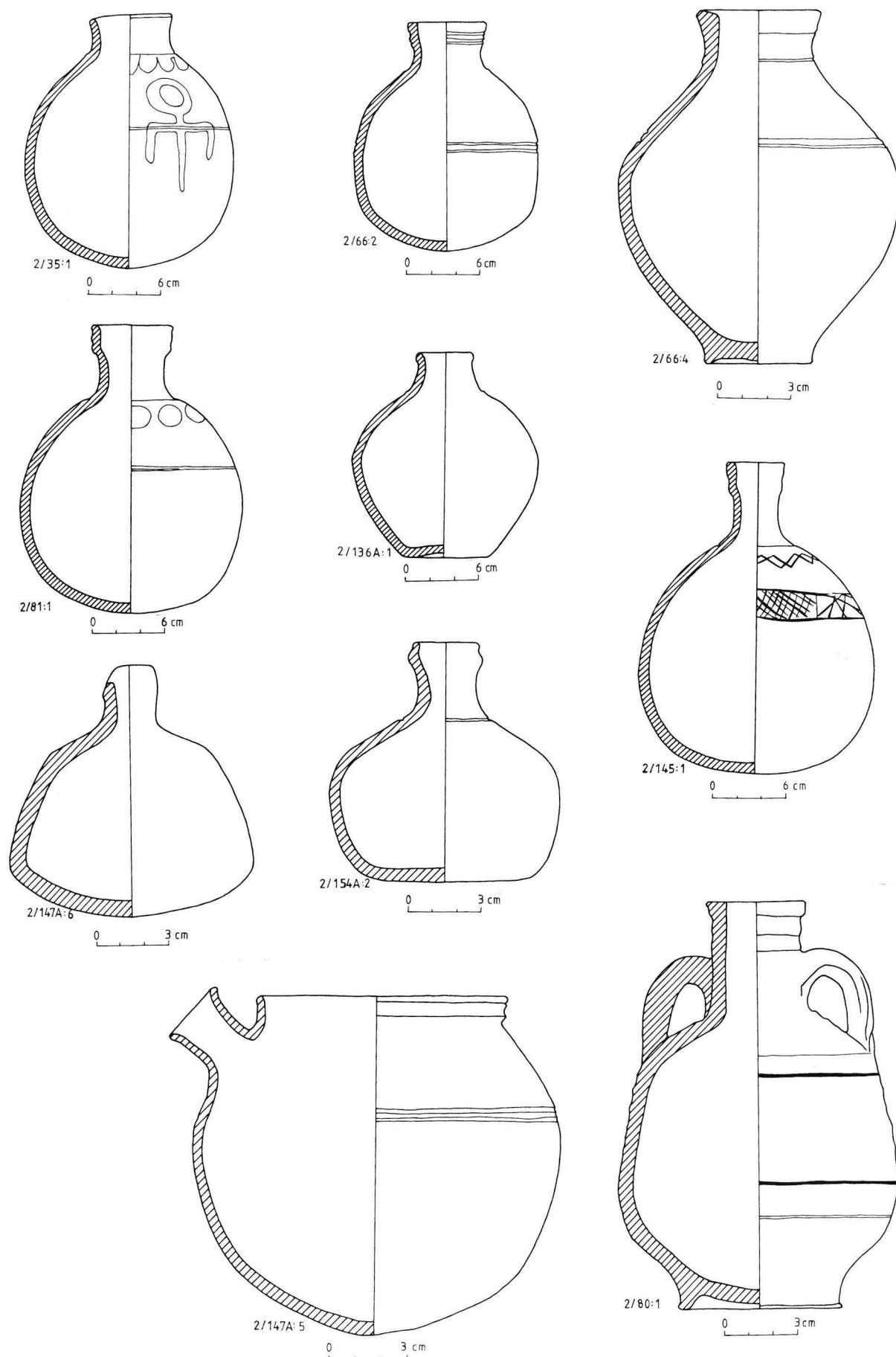

158. Site 2. **Bottles:** Classic X-group red ware, *NII/R1*, nos. 35:1;66:2;81:1,145:1,154A:2. Early X-group brown ware, Egyptian made specimen, *T/R25*, no. 136A:1. *T/R25* or *W28*, no. 147A:6. **Pitcher:** Transitional red ware, *NII/R2*, no. 147A:5. **Lekythos:** *AI/R30(M13)*, no. 80:1.

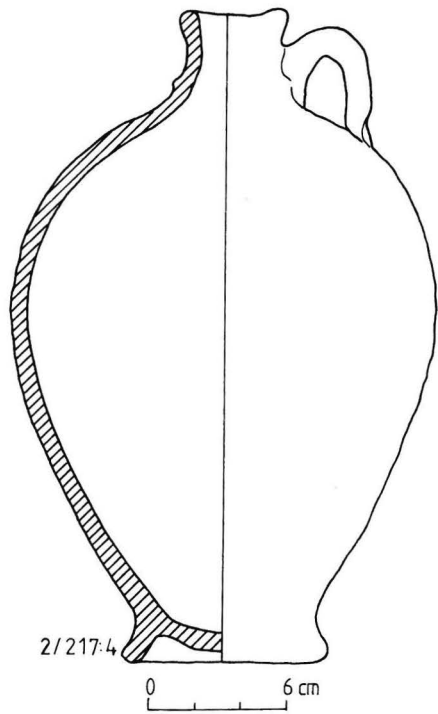
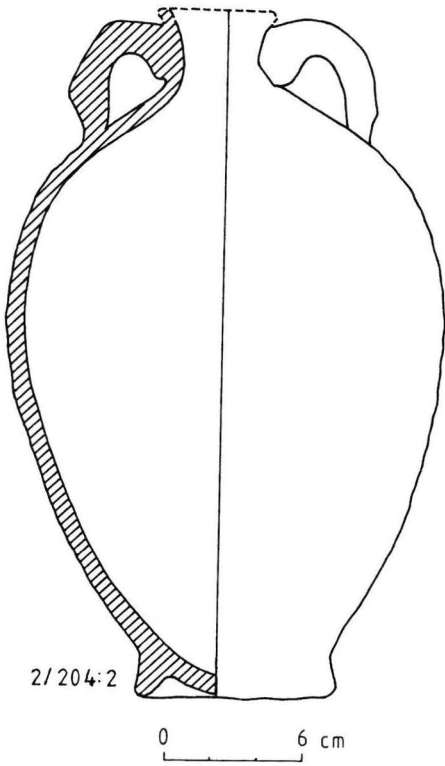
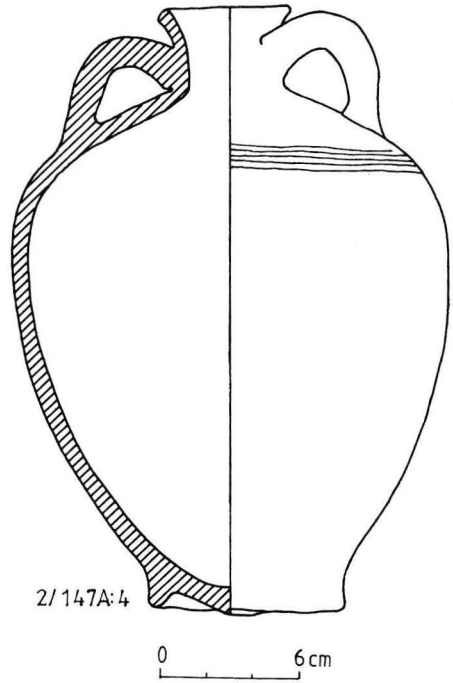
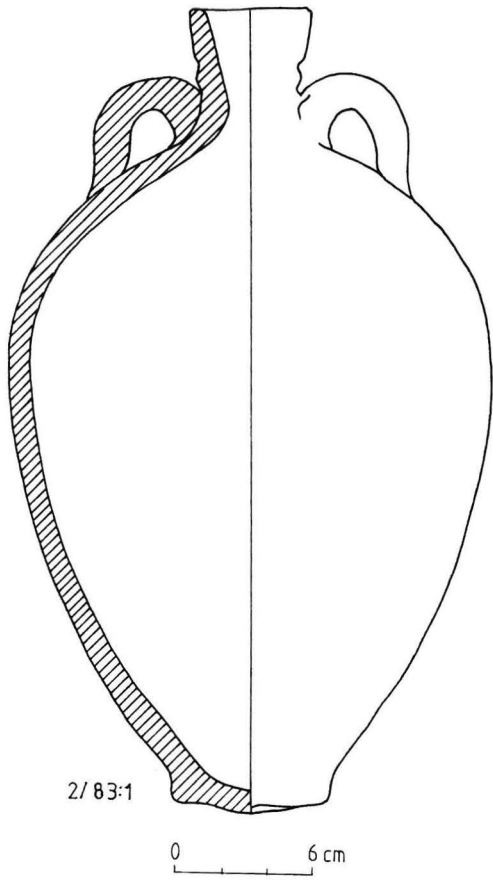

159. Site 2. Ceramic repertoire. **Amphorae:** Middle Egyptian plain utility white ware, *T/W28*, no. 83:1. Classic X-goup red ware, *NII/RI*, no. 147A:4. *T/W2I*, no. 204:2. Early X-goup brown ware, *T/R25* or *RI*, no. 217:4.

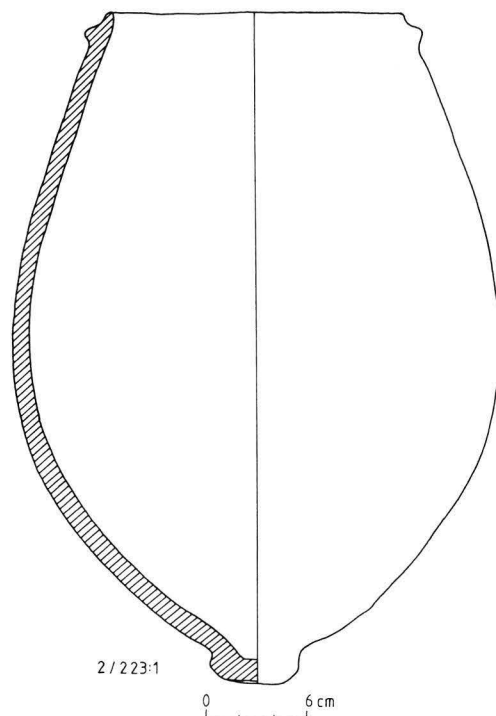
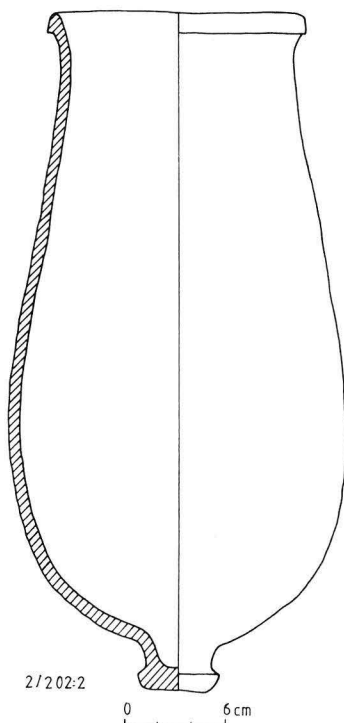
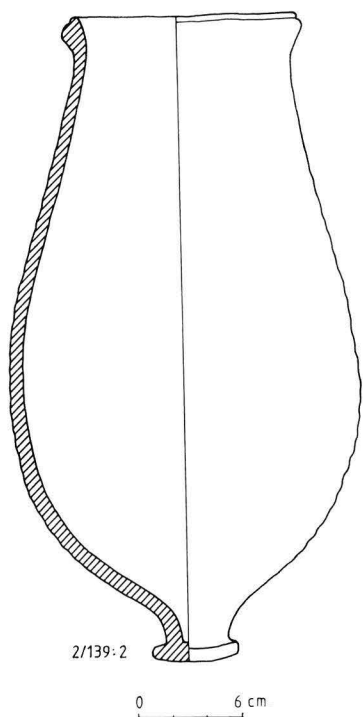
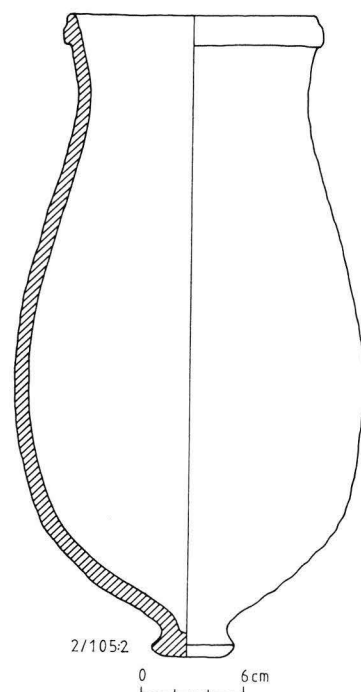
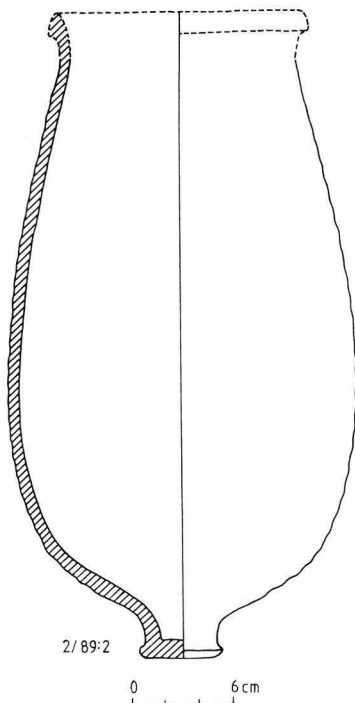
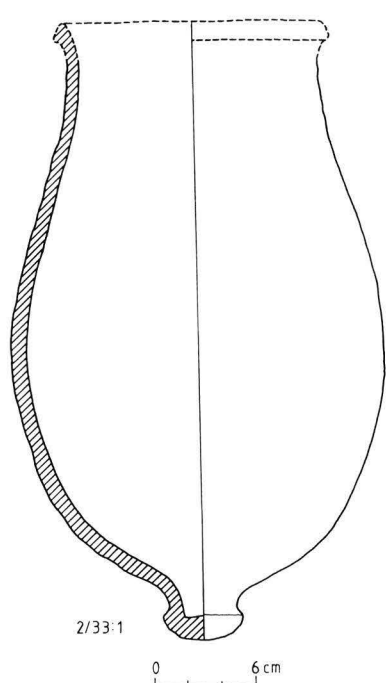

160. Site 2. Ceramic repertoire. **Qaduses**: Pre-Christ. brown utility ware, *NU/UI*, nos. 33:1,89:2,105:2,139:2,202:2. Christ. red utility ware, *NU/U5*, no. 223:1.

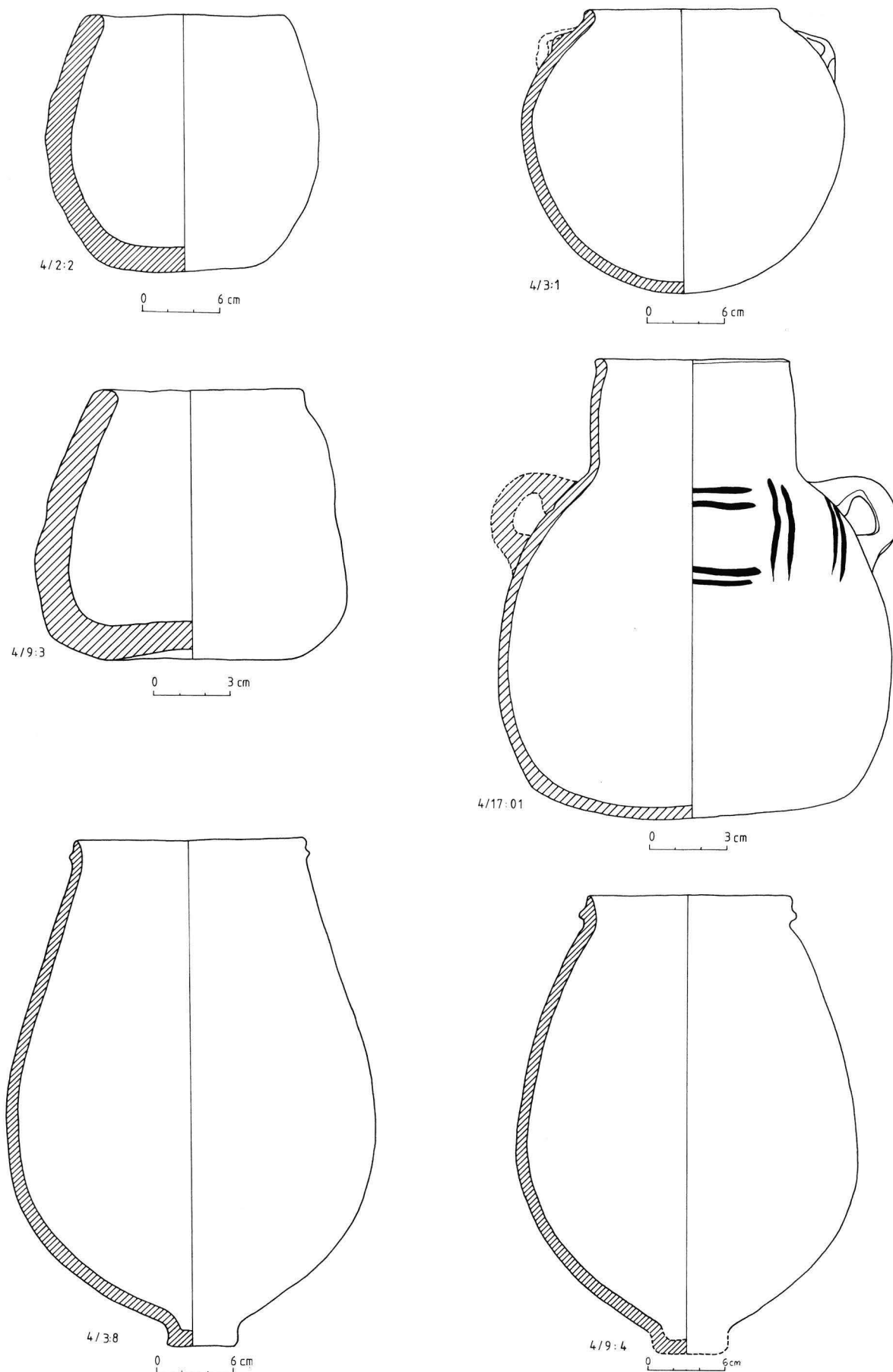

161. Site 4. Ceramic repertoire. **Pots:** Later Christ. slipped utility ware, *NU/U14*, no. 2:2. Later Christ. pink utility *NU/U10*, no. 3:1. Later domestic plain utility ware, *DIII/H4*, no. 9:3. Aswan Medieval white ware, *AIV/W12*, no. 17:01. **Qaduses:** Christ. red utility ware, *NU/U5*, nos. 3:8,9:4.

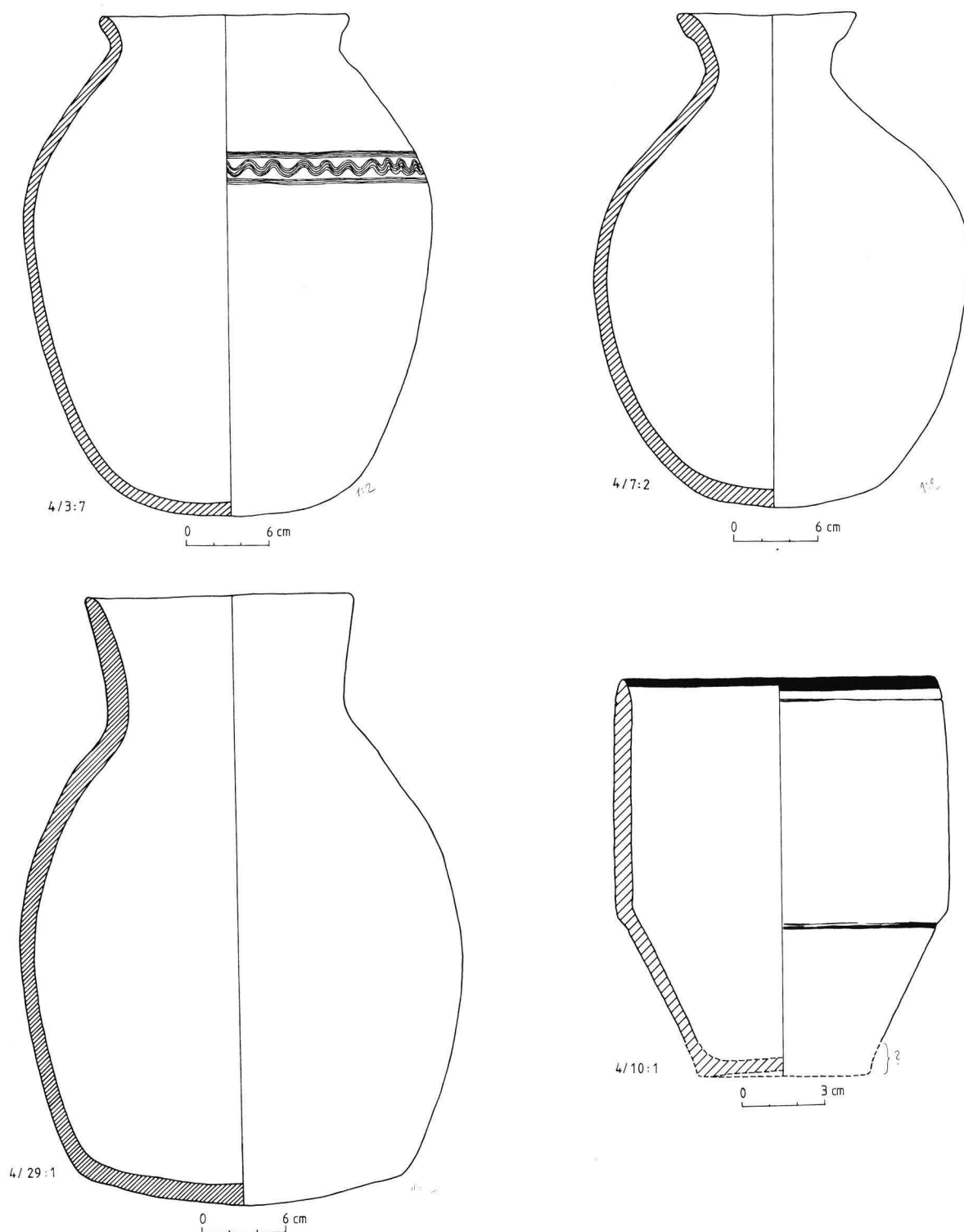

162. Site 4. Ceramic repertoire. **Jars:** Christ. red utility ware, *NU/U5*, no. 3:7. Later Christ. pink utility ware, *NU/U10*, no. 7:2. Later Christ. red domestic ware, *DIII/H5*, no. 29:1. **Goblet:** Terminal Christ. polished orange ware, *NVII/R26*, no. 10:1.

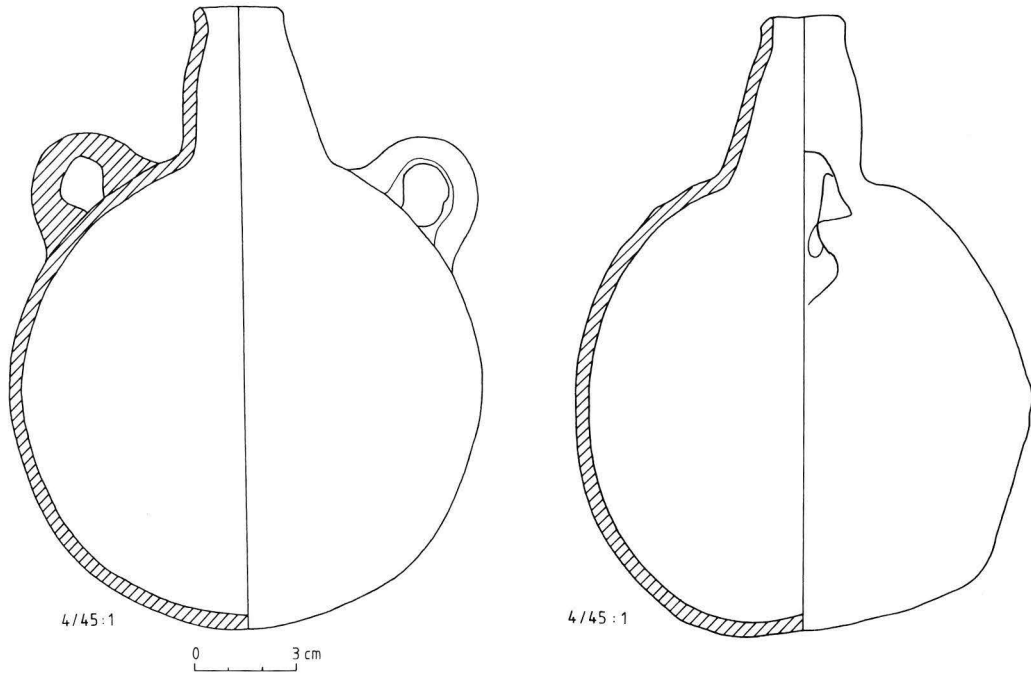

163. Site 4. Ceramic repertoire. **Pilgrim bottle**: Aswan Islamic plain red ware, *AIV?*, *R13?* no. 45:1.

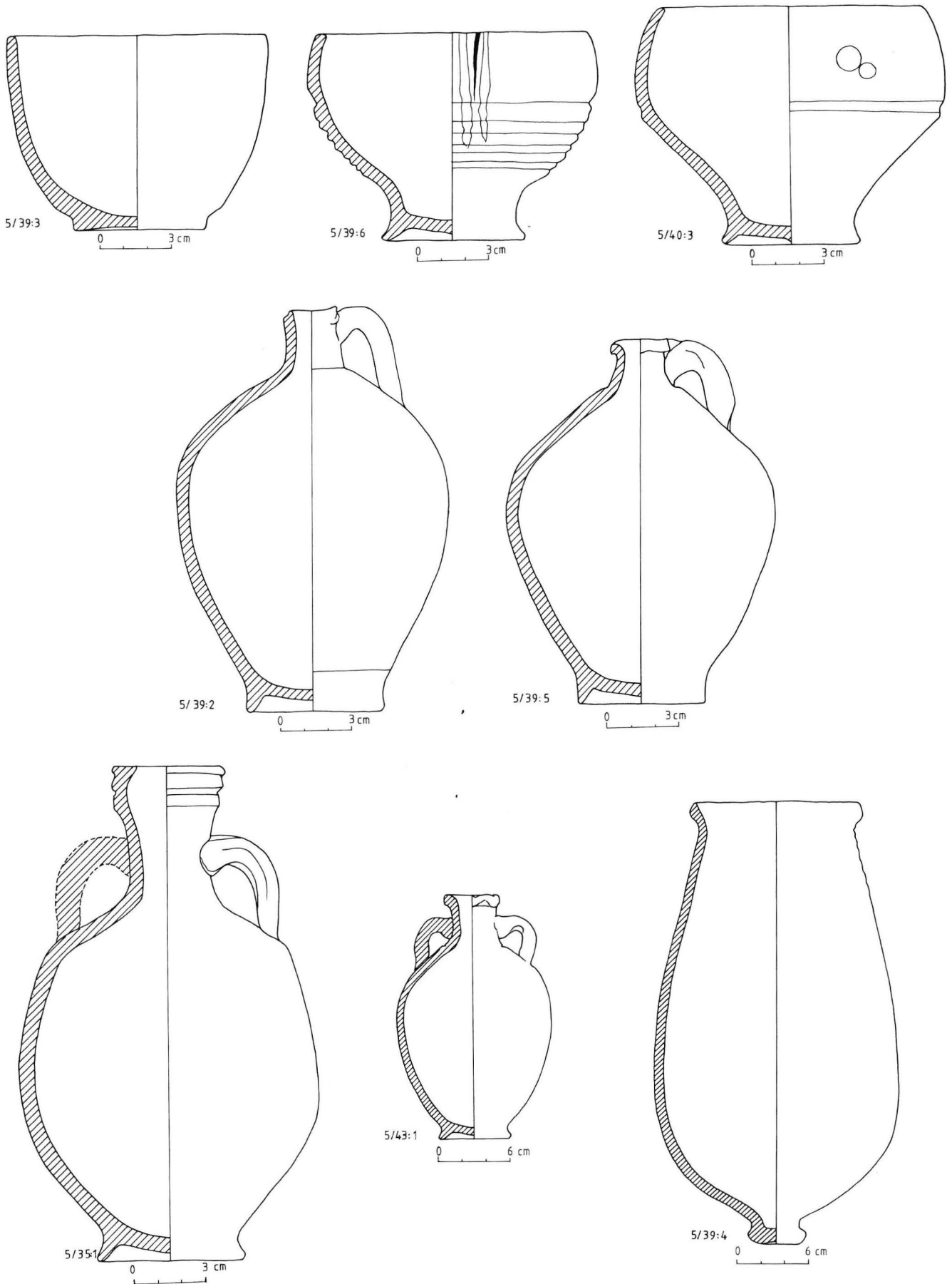

164. Site 5. Ceramic repertoire. **Goblets**: Early X-group brown utility ware, *T/R25*, no. 39:3. Classic X-group red ware, *NI/R1*, nos. 39:6,40:3. **Lekythoses**: Aswan Graeco-Roman flaky pink ware, *AI/R31*, nos. 39:2,5. **Amphorae**: Aswan Graeco-Roman ordinary red ware, *AI/R30*, no. 35:1. Middle Egyptian plain white ware, *T/W28*, no. 43:1. **Qadus**: Pre-Christ. brown utility ware, *NU/U1*, no. 39:4.

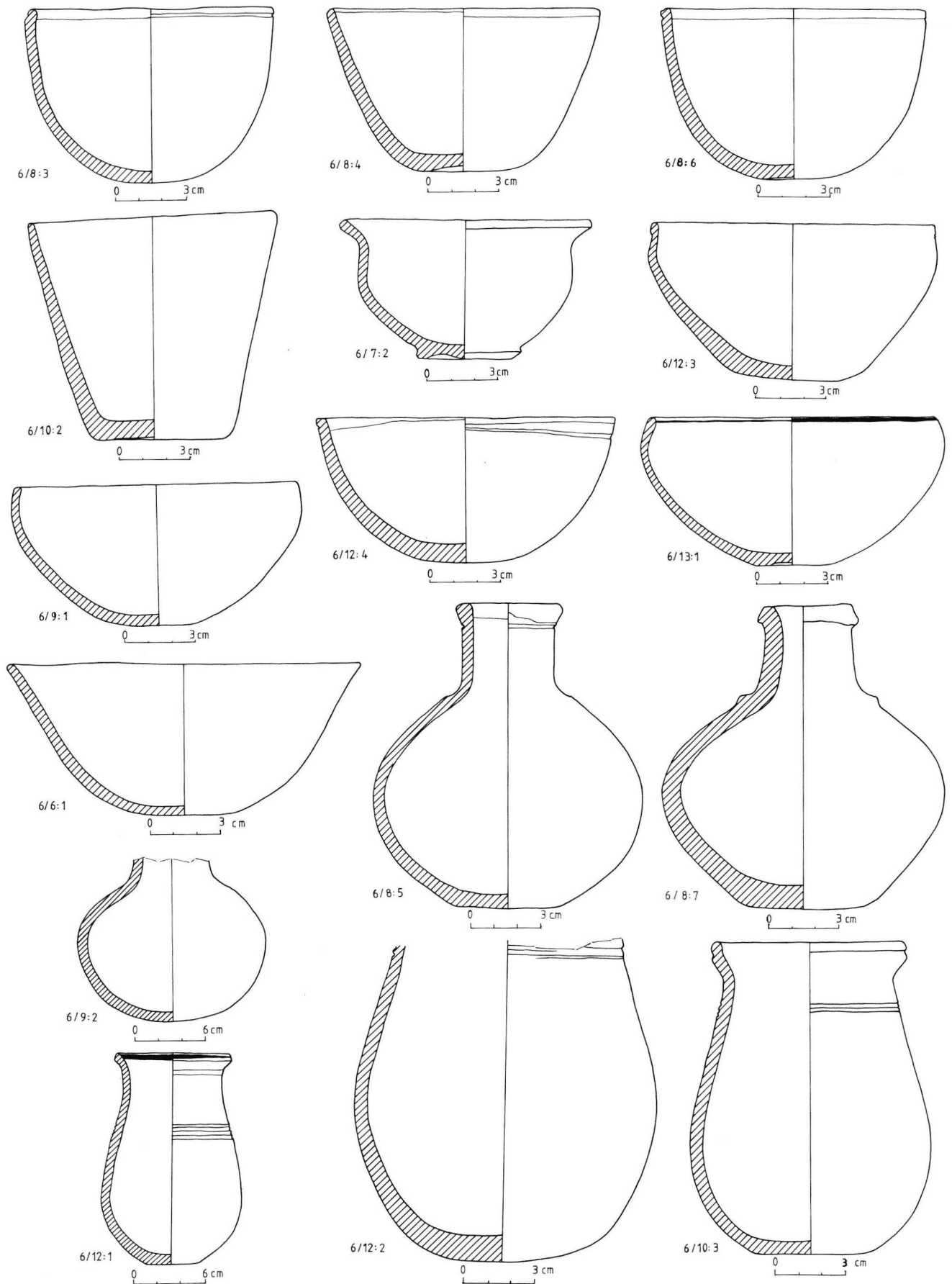

165. Site 6. Ceramic repertoire. **Cups:** Early Christ. matte white ware, *NIII/W2*, nos. 8:3,4,6;10:2. **Bowls:** *NIII/W2*, nos. 12:3,4;13:1. **Footed bowl:** *NIII/W2*, no. 7:2. *NII/W2?*, no. 9:1. Early Christ. polished red ware, *NIII/R5*, no. 6:1. **Bottles:** *NIII/W2*, no. 8:5. Transitional red ware, *NIII/R2*, nos. 8:7(?),10:3,12:1,2. Earlier Christ. red domestic ware? *DII/H3?* no. 9:2.

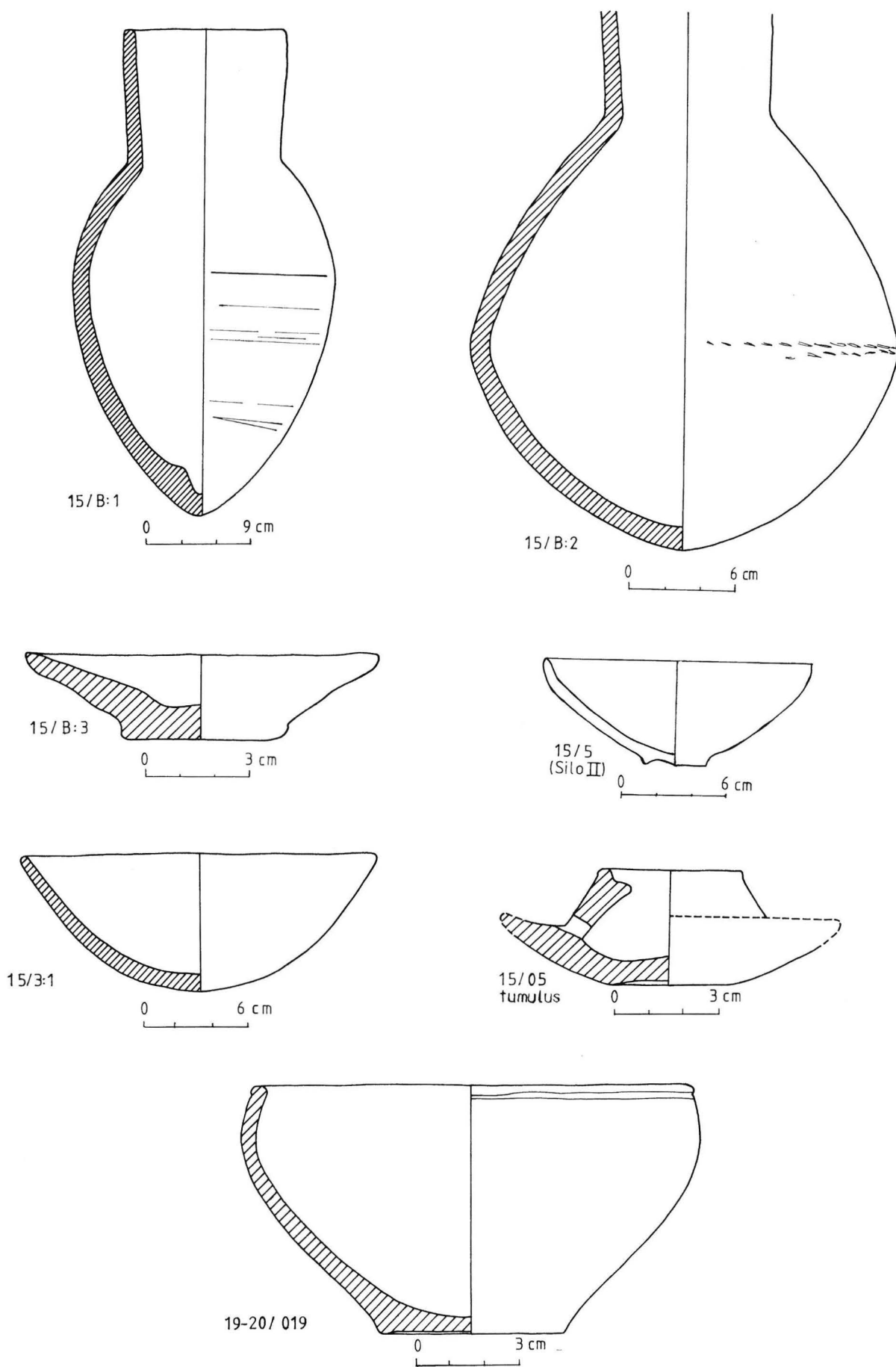

166. Site 15. Ceramic repertoire. **Necked jars:** uncoat. brown, coarse ware *W1.01*, no. B:1. Brown, coarse red-coat. ware *W1.11*, no. B:2. **Plates:** *W1.01*, no. B:3. Brown, red-coat. and polished ware *W1.13*, no. II/5. **Bowl:** *W1.01*, no. 3:1. **Lamp:** Early Christ. matte white ware, *NII* or *NIII/W2* or *W6*, no. T/05. Site 19–20. **Bowl:** *NIII/W2*, no. 019.

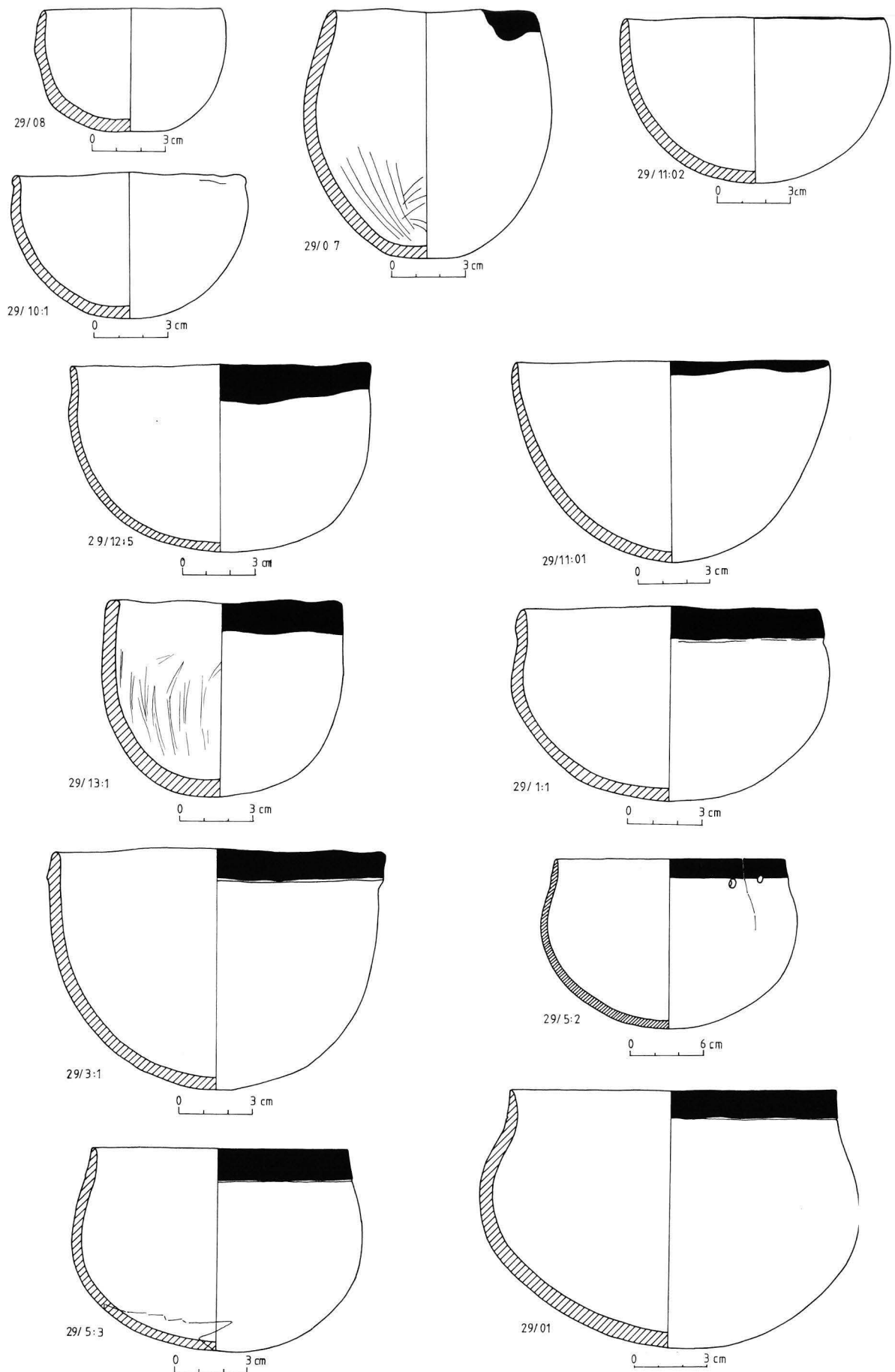

167. Site 29. Ceramic repertoire. **Bowls:** uncoat. brown ware, *H1.01A*, no. 08. Uncoat. brown ware, interior black, *H1.01B*, nos. 11:02;07. Red-coat. plain polished ware. *H2.11*, no. 10:1. Ware *H4.11*, no. 12:5. Black-topped red-coat. variant, *H4.11C*, nos. 11:01,13:1. Black-topped Pangrave-ware, *H4.11F*, nos. 1:1,3:1;5:2,3;01.

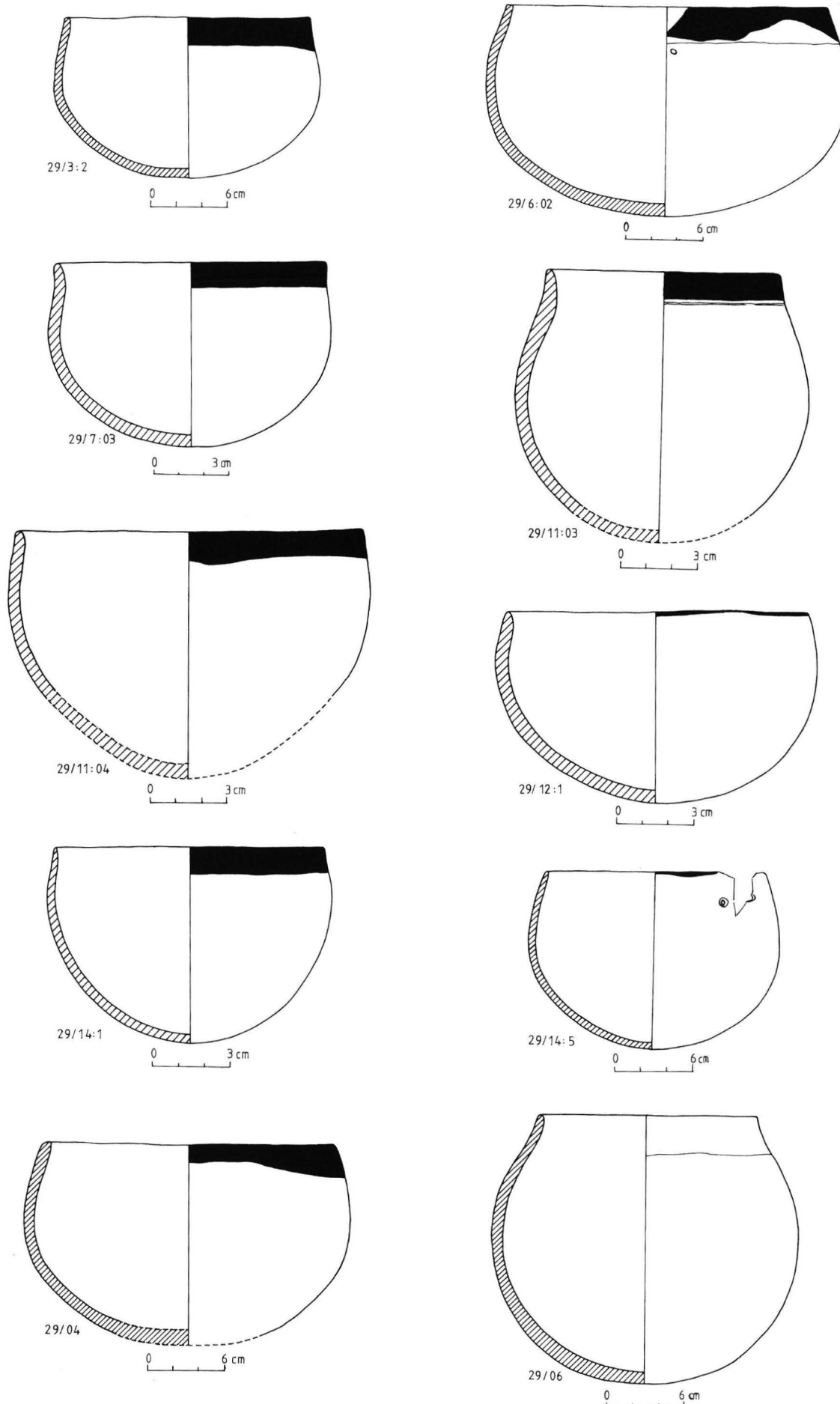

168. Site 29. Ceramic repertoire. **Bowls:** black-mouth. red ware, *H4.11D*, nos.3:2,6:02,7:03;11:03,04;12:1;14:1,5; 04,06.

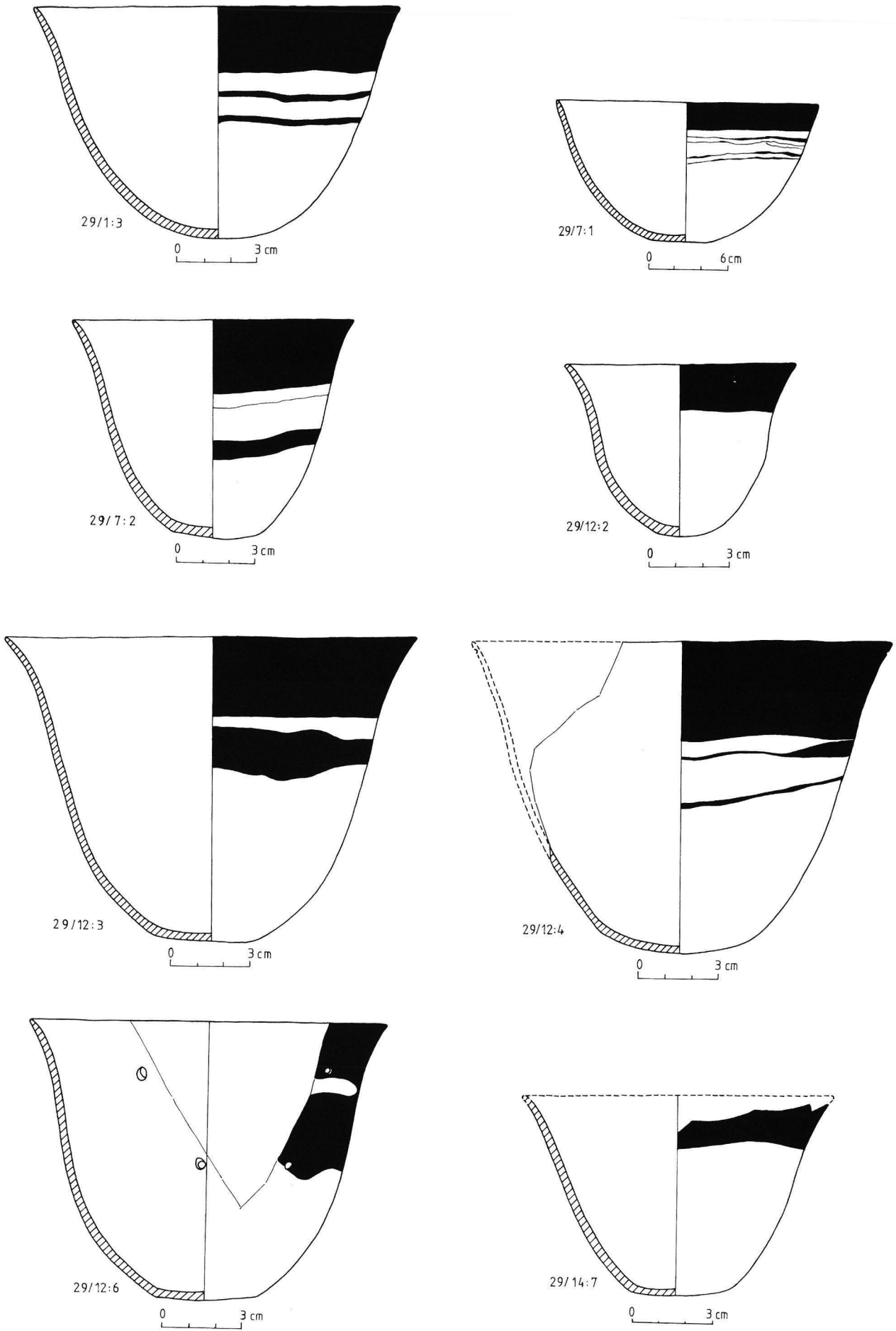

169. Site 29. Ceramic repertoire. **Beakers:** red-and-black Kerma ware, *H4.15*, nos. 1:3;7:1,2;12:2,3,4,6;14:7.

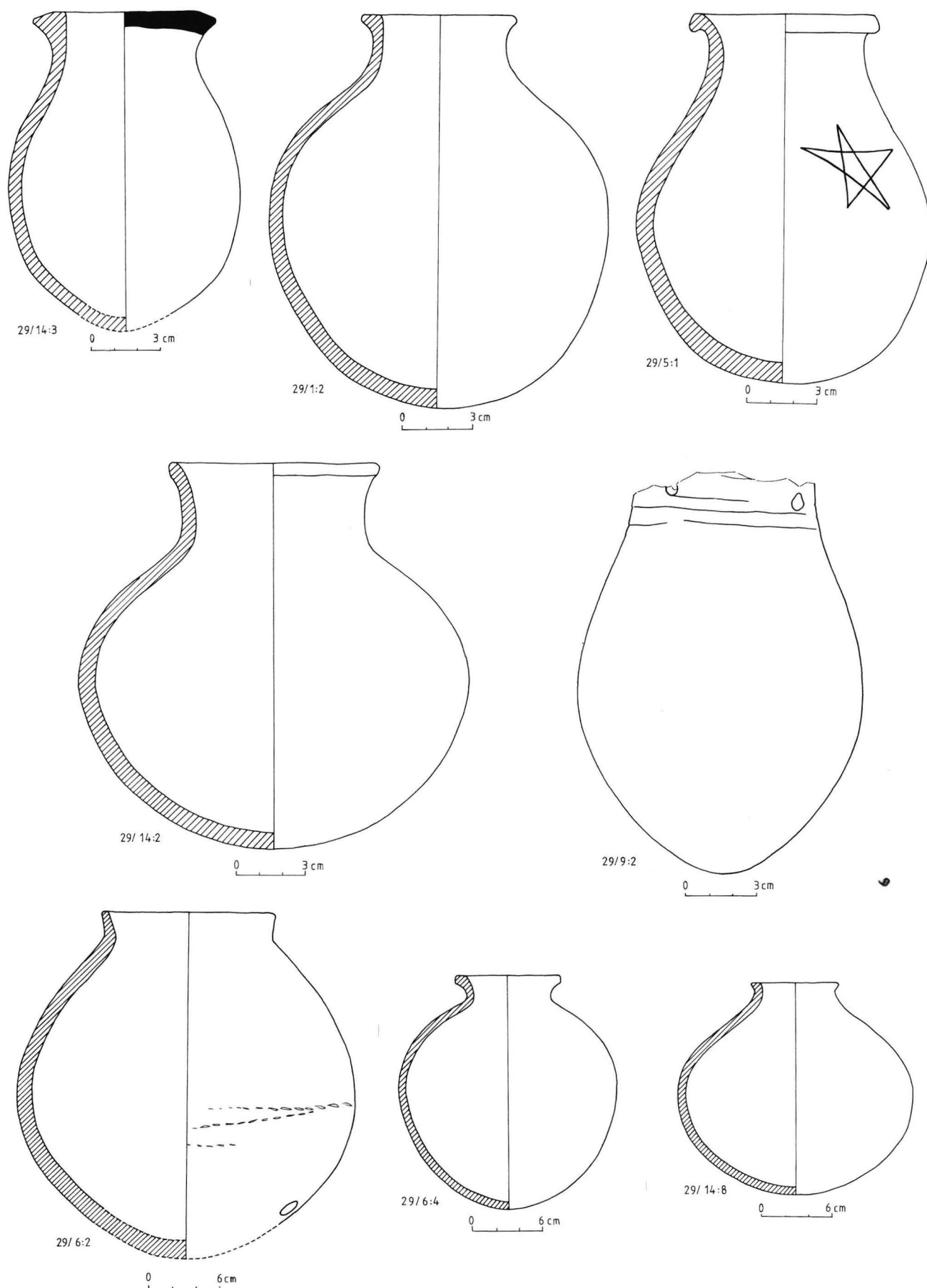

170. Site 29. Ceramic repertoire. **Jars:** uncoat. brown ware, rimtop black. *H1.01B*, no. 14:3. Polished brown ware, *H2.01C*, no. 5:1. Plain red-polished ware with uncom. int. *H2.13*, nos. 1:2, 14:2. **Wheelmade wares:** uncoat. brown, coarse ware, *W1.01*, no. 9:2. Uncoat. brown ware with polished exterior, *W1.02*, no. 6:2. Brown, coarse red-coat. ware, *W1.11A*, no. 6:4. Hard, pink slip-ware with polished exterior, *W3.22*, no. 14:8.

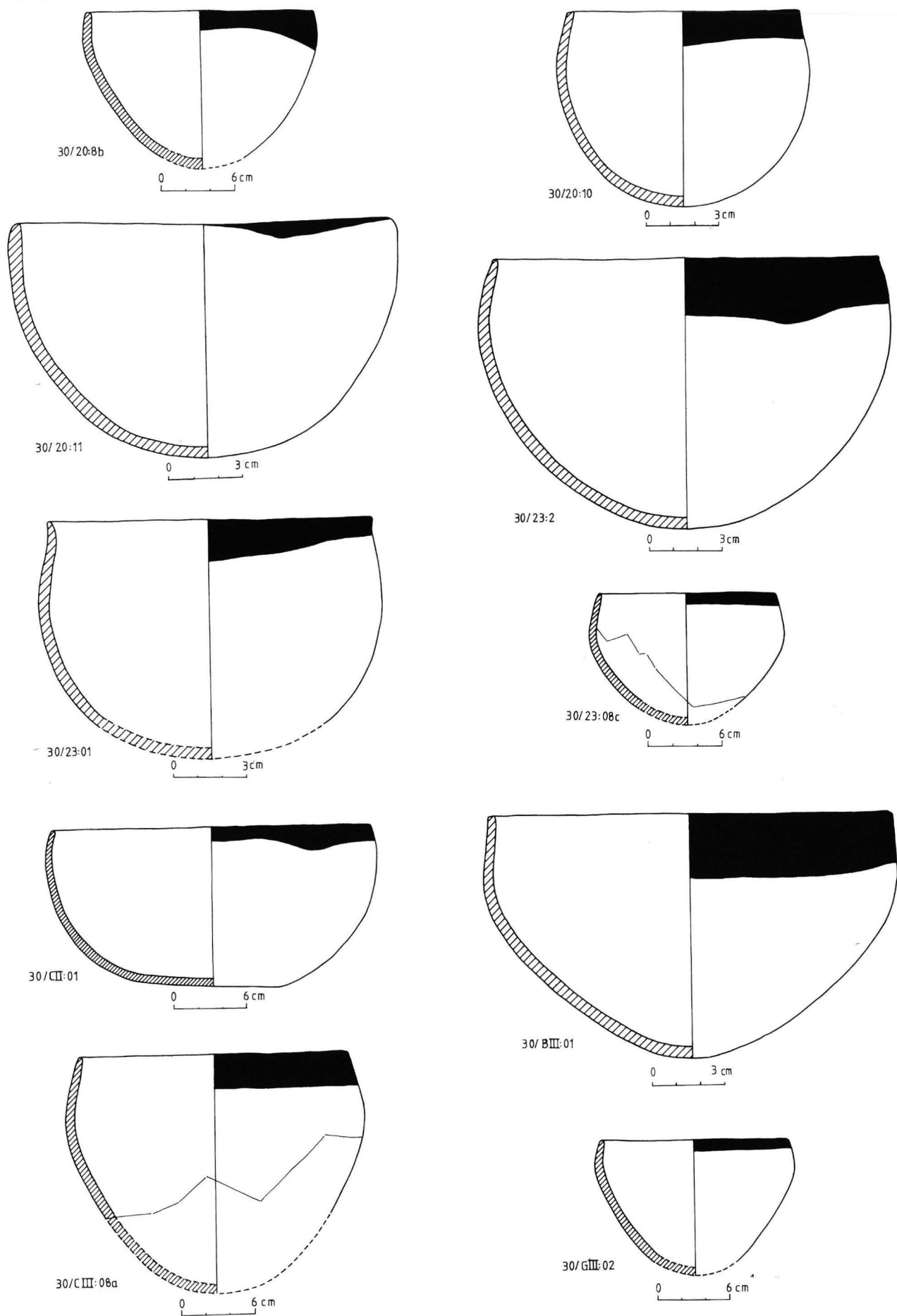

171. Site 30. Ceramic repertoire. **Bowls**: plain, polished black-and-red ware, *H4.11*, nos. 20:8b,10,11;23:2,01,08c; CII:01, BIII:01, CIII:08a, GIII:02.

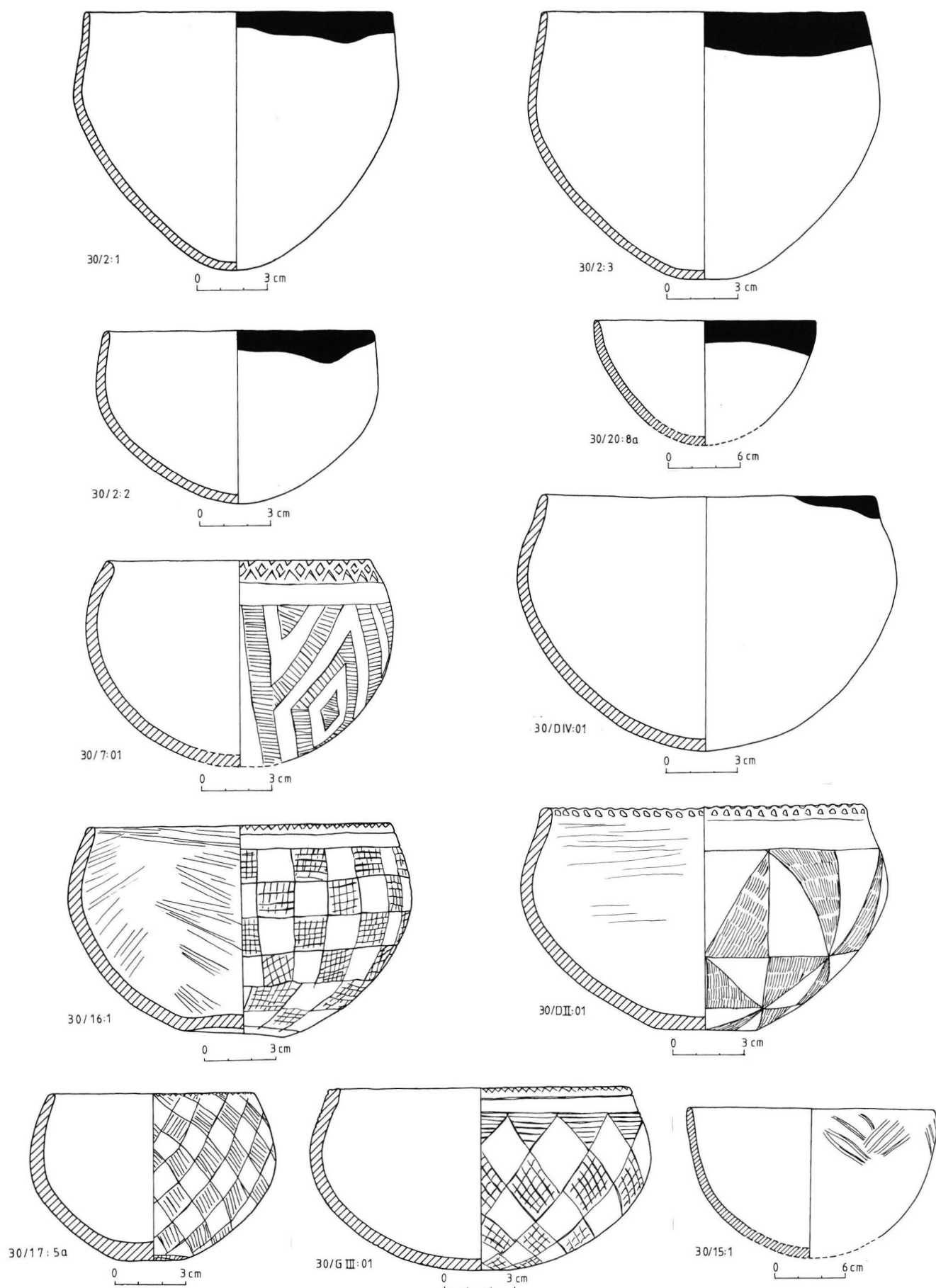

172. Site 30. Ceramic repertoire. **Bowls:** thin-walled variant, *H4.11A*, nos. 2:1,2,3. Plain polished brown-and-black ware, *H4.01*, nos. 20:8a,DIV:01. Incised decor. wares, *H3.03*, nos. 7:01,16:1,17:5a. Plain, polished black ware, *H3.01* no. GIII:01. Uncoat. brown ware, *H1.01B*, no. 15:1. Plain polished red-and-black ware with uncomp. int., *H4.13*, no. DII:01.

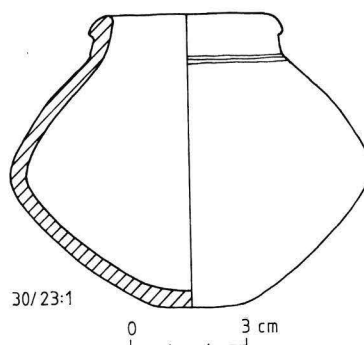
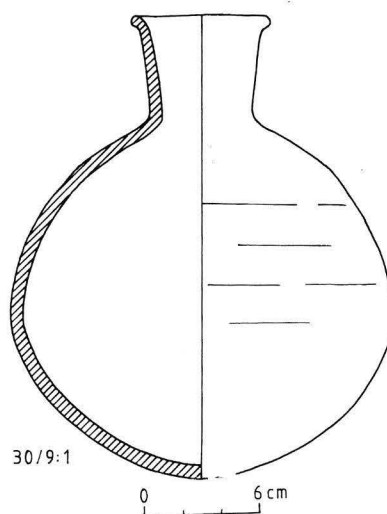
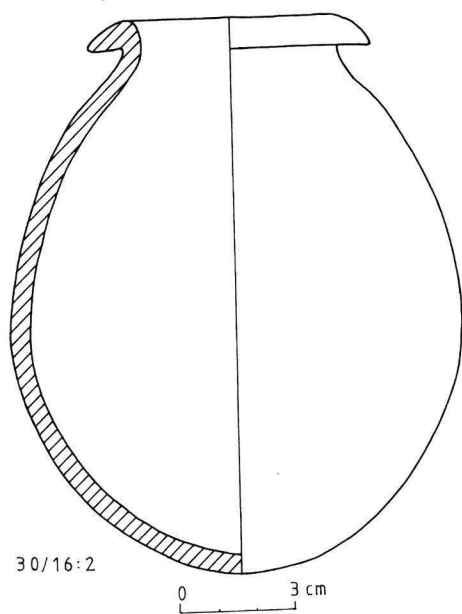
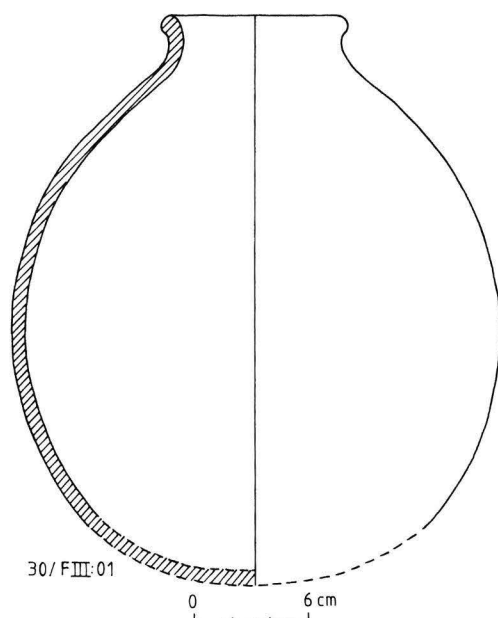
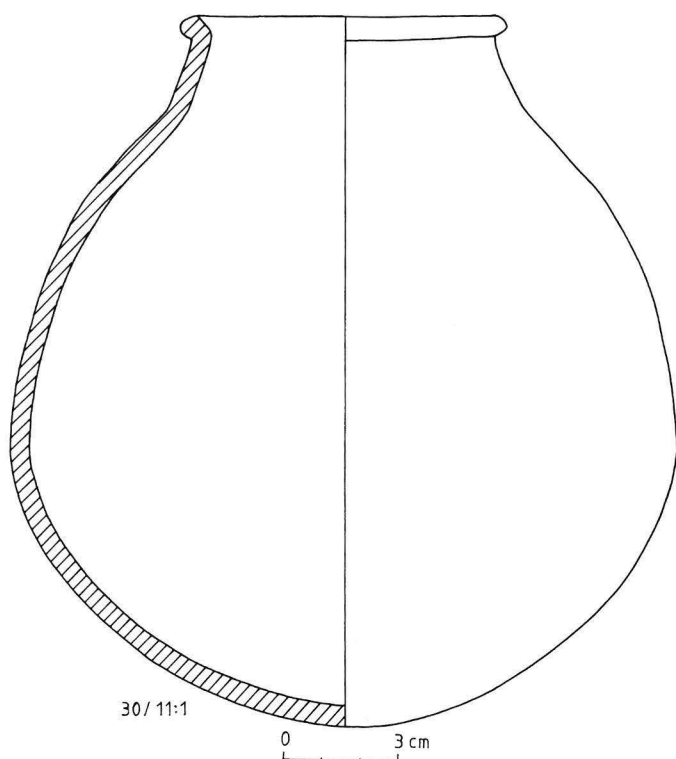

173. Site 30. Ceramic repertoire. **Jars:** wheelmade wares, hard, unpolished Qena ware, W5.01, nos. 11:1, FIII:01. Black, unpolished ware, W2.01, no. 23:1. Handmade plain, red-polished ware with uncomp. int. H2.13, no. 16:2. Bottle: hard, pink, unpolished slip-ware, W3.21, no. 9:1.

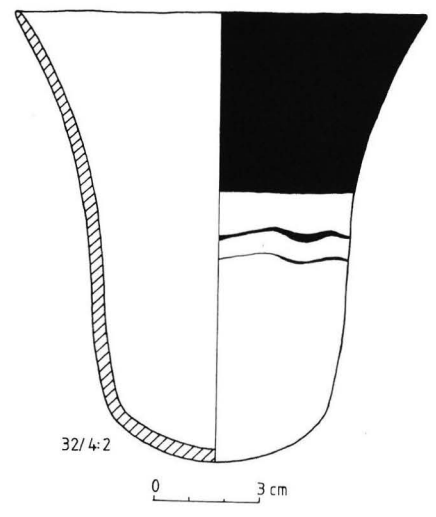
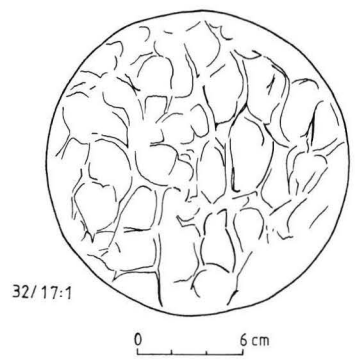
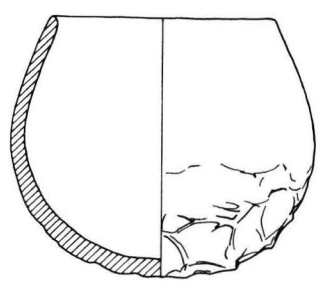
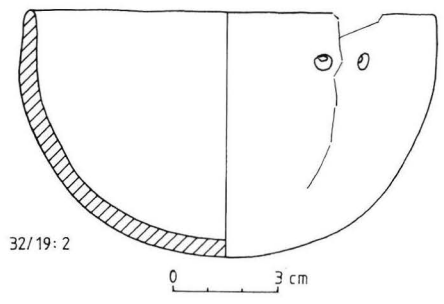
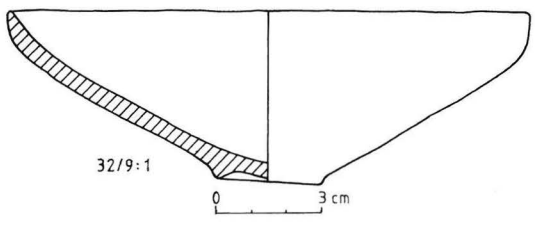
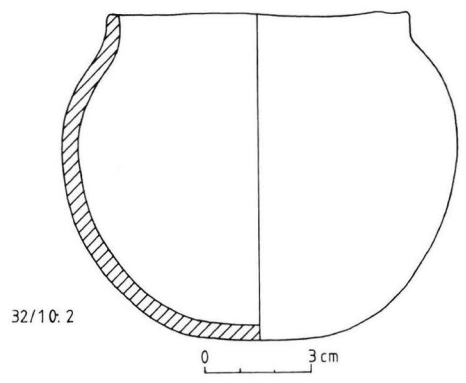
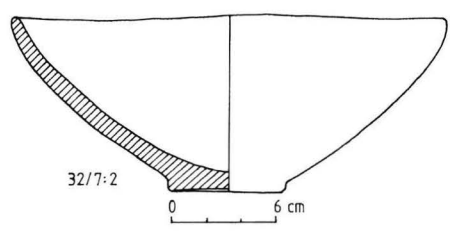
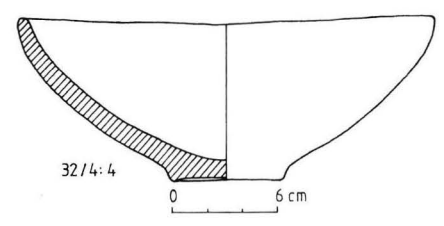
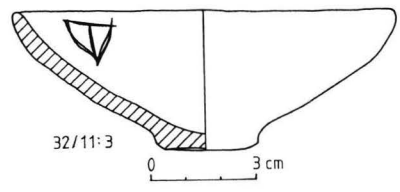
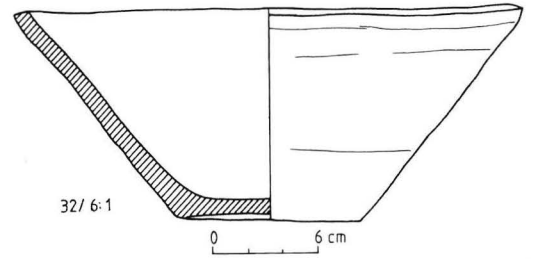
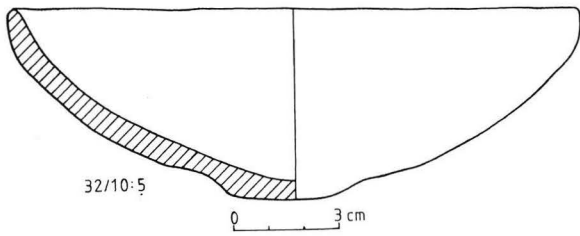

174. Site 32. Ceramic repertoire. **Plates:** brown, red-coat. ware with polished int. *W1.14*, nos. 10:5,11:3. **Bowls:** *W1.14*, nos. 4:4,7:2,9:1. Brown, uncoat. coarse ware, *W1.01*, nos. 6:1,17:1. Uncoated, smooth brown ware, *H1.01*, no. 10:2. Polished, red-and-black ware, *H4.11D*, no. 19:2. **Beaker:** red-and-black Kerma-beaker, *H4.15*, no. 4:2.

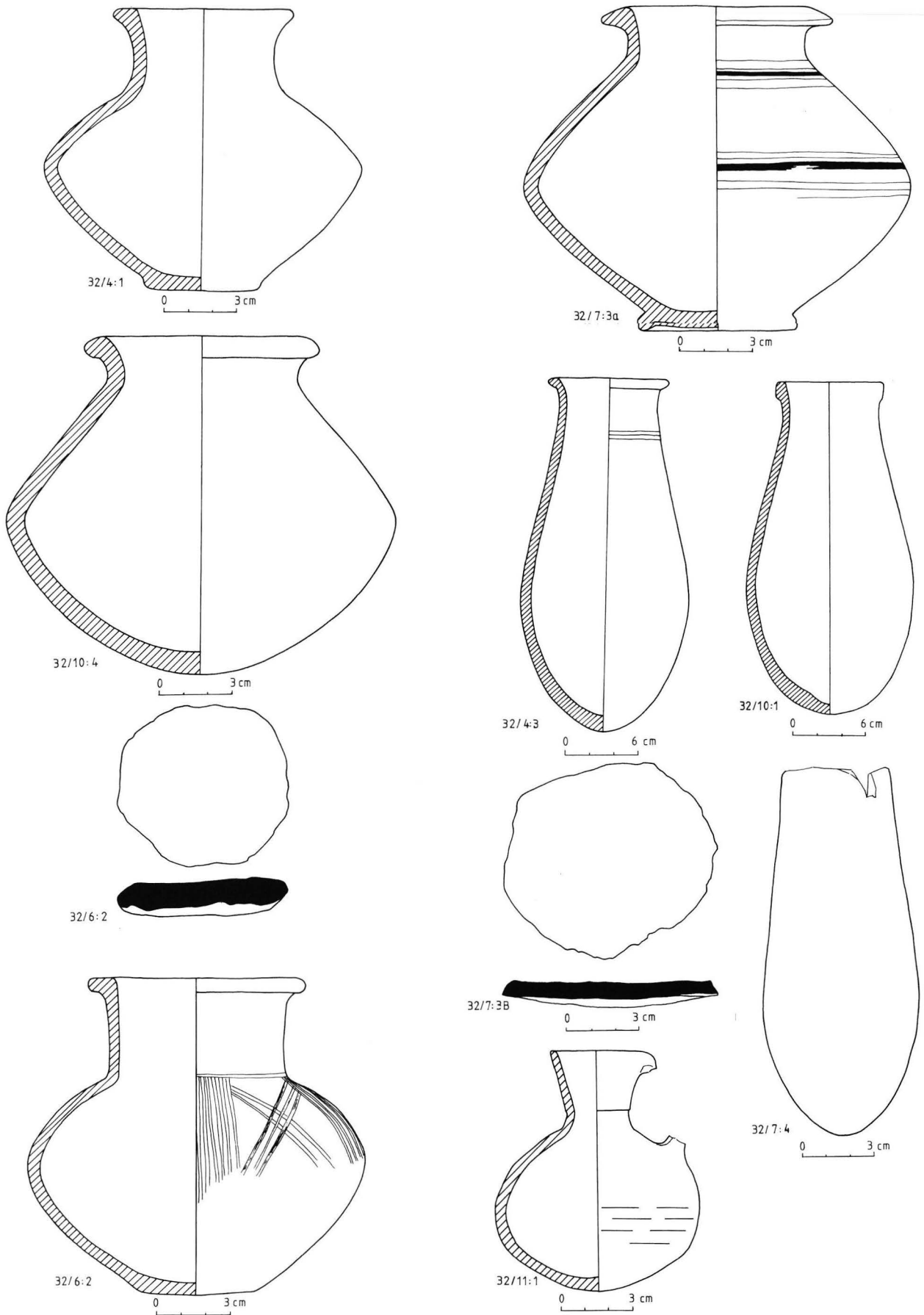

175. Site 32. Ceramic repertoire. **Jars:** brown, red-coat. ware with polish. ext., *W1.12*, no. 4:1. Hard, pink slip-ware with polish. ext., *W3.22*, no. 6:2. Brown, uncoat. ware with polish. ext., *W1.02*, nos. 10:4,7:4. Hard, red-coat. pink ware with polish. ext., *W3.12*, no. 7:3a. Brown, uncoat. coarse ware, *W1.01*, no. 4:3. Brown, coarse red-coat. ware, *W1.11*, no. 10:1. **Lid:** uncoat. smooth brown ware, *H4.01*, no. 7:3b. **Jug:** *W1.11*, no. 11:1.

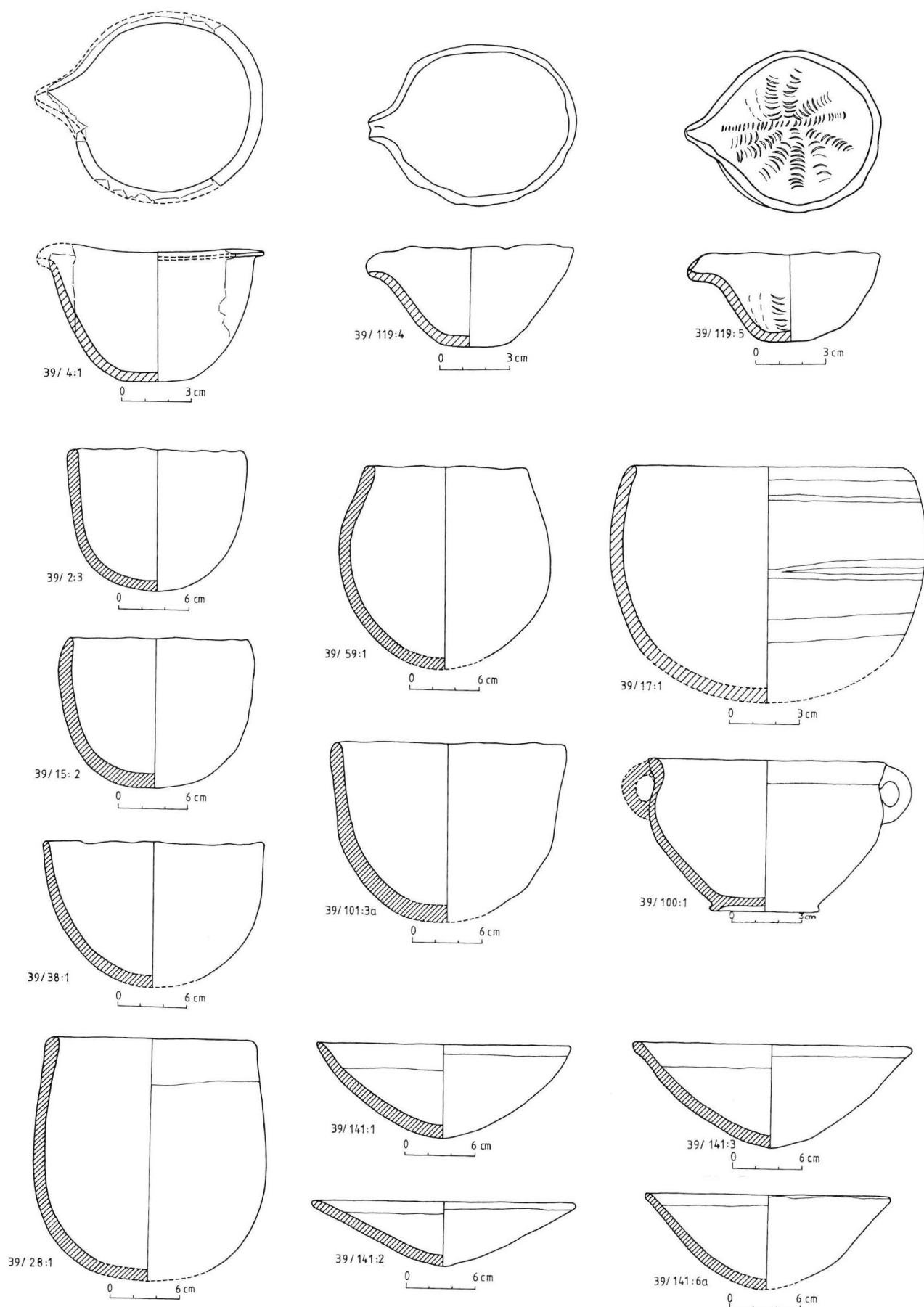

176. Site 39. Ceramic repertoire. **Beakers:** Meroitic burnished domestic ware, *DI/H9*, no. 4:1. Meroitic fine black domestic ware, *DI/H11*, nos. 119:4,5. **Bowls:** *DI/H9*, nos. 2:3, 15:2,38:1. **Pot:** *DI/H9*, no. 28:1. Early domestic plain utility ware, *DI/H1*, nos. 59:1,101:3a. Meroitic ordinary white ware, *NI/W25*, no. 17:1. Wheelmade, hard, unpolished Qena-ware, *W5.O1*, no. 100:1. **Plates:** wheelmade, brown, coarse, red-coated ware, *W1.I1*, nos. 141:1,2,3,6a.

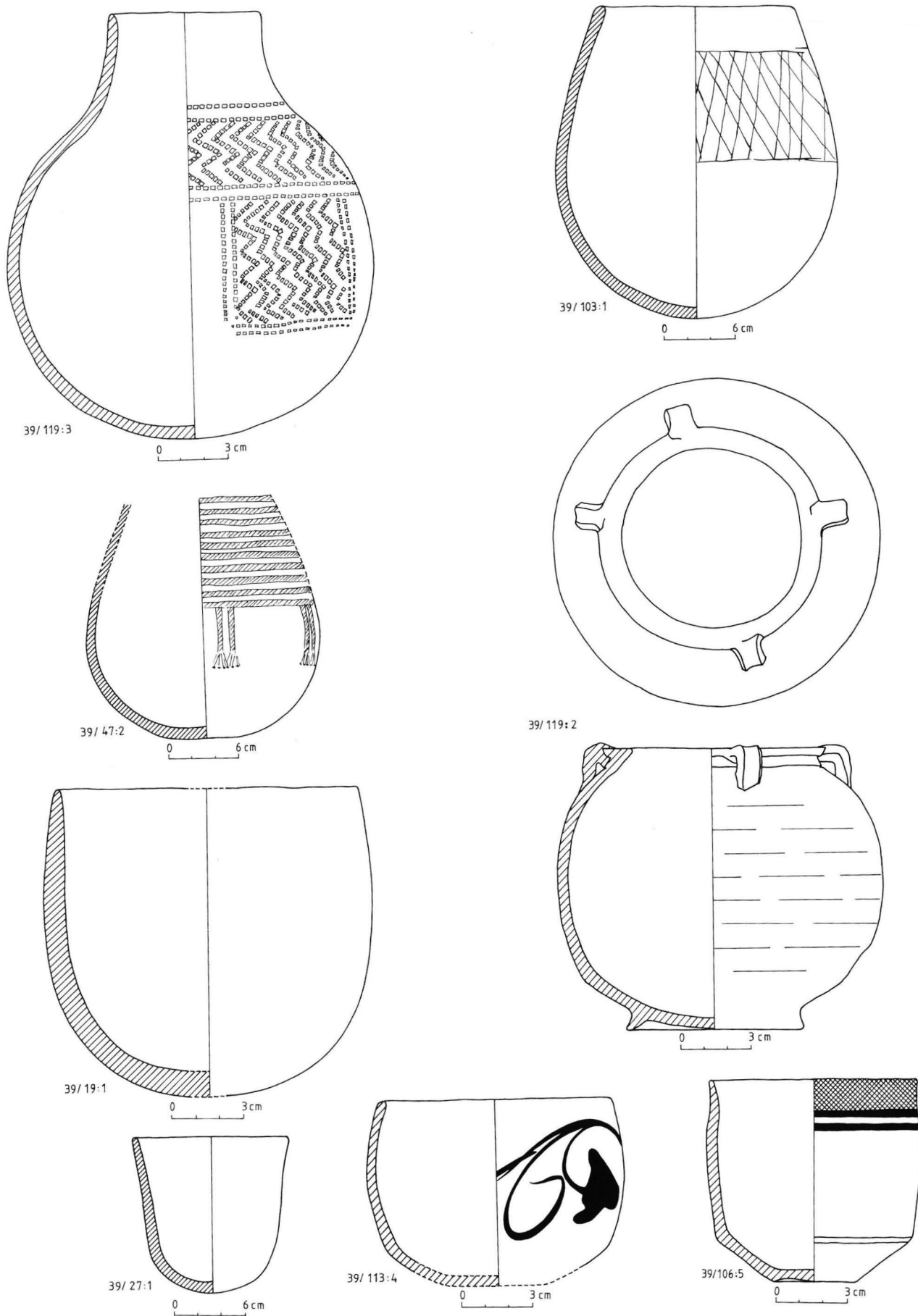

177. Site 39. Ceramic repertoire. **Jars**: Meroitic burnished domestic ware, *DI/H9*, no. 103:1. Meroitic fine black domestic ware, *DI/H11*, nos. 119:3,47:2. Aswan Graeco-Roman ordinary red ware, *AI/R30*, no. 119:2. **Cups**: *DI/H9*, nos. 19:1,27:1. *AI/R30*, no. 113:4. Meroitic fine white ware, *M/W26*, no. 106:5.

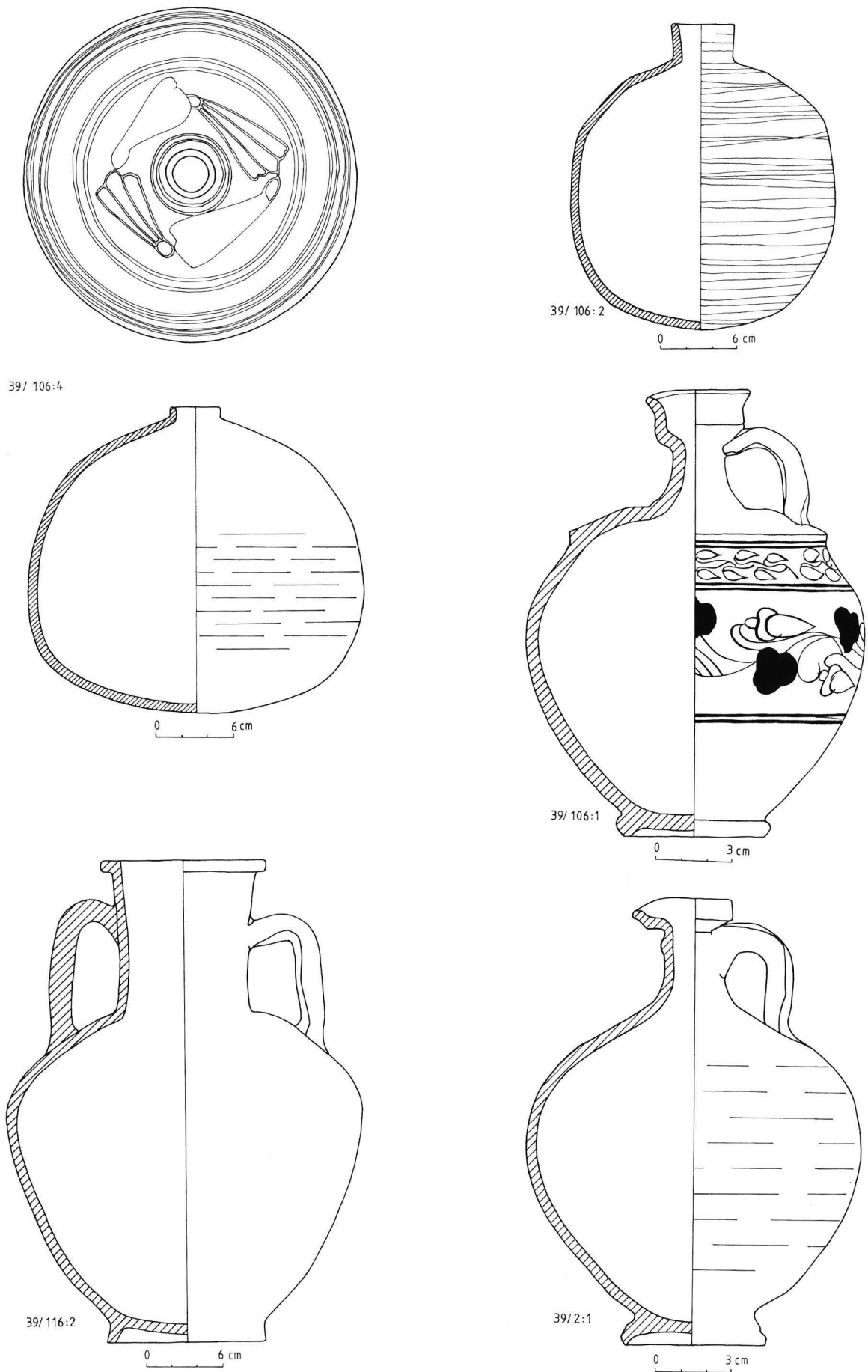

178. Site 39. Ceramic repertoire. **Bottles:** Meroitic ordinary white ware, *NI/W25*, no. 106:4. Meroitic ordinary red ware, *NI/R32*, no. 106:2. **Amphora:** Aswan Graeco-Roman ordinary red ware, *AI/R30*, no. 116:2. **Lekythoses:** Meroitic ordinary white ware, *M* or *NI/W25* or 26, no. 106:1. (in Khartoum). *AI/R30(?)*, no. 2:1.

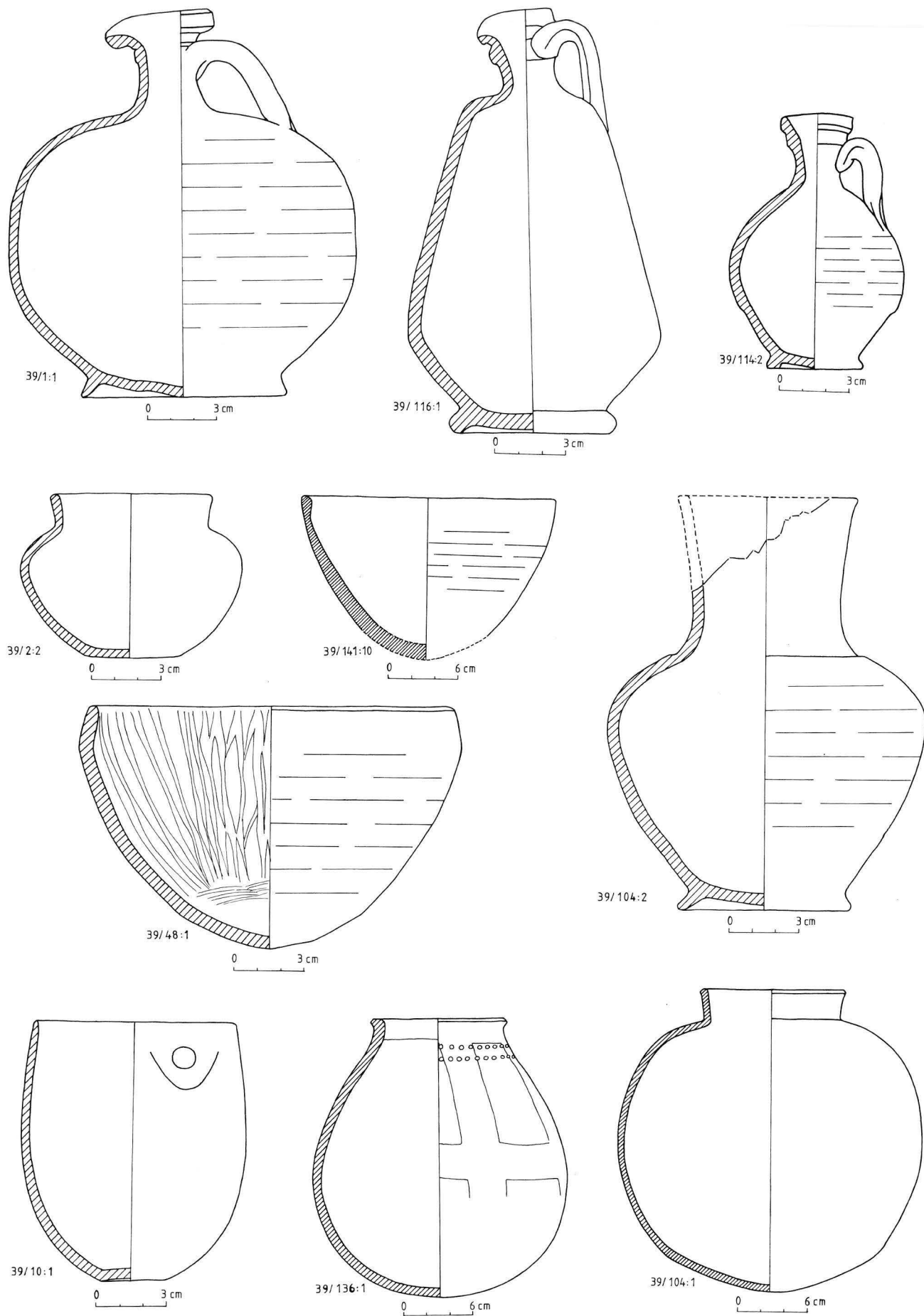

179. Site 39. Ceramic repertoire. **Jug:** *AIV/R30(?)*, no. 1:1. **Pitcher:** Aswan Graeco-Roman ordinary red ware, *AIV/R30*, nos. 116:1 (in Khartoum), 114:2. Pre-Meroitic: **bowls:** nos. 2:2,48:1,141:10. **Cup:** no 10:1. **Jars:** nos. 136:1, 104:1. Pharaonic: **jar:** no. 104:2.

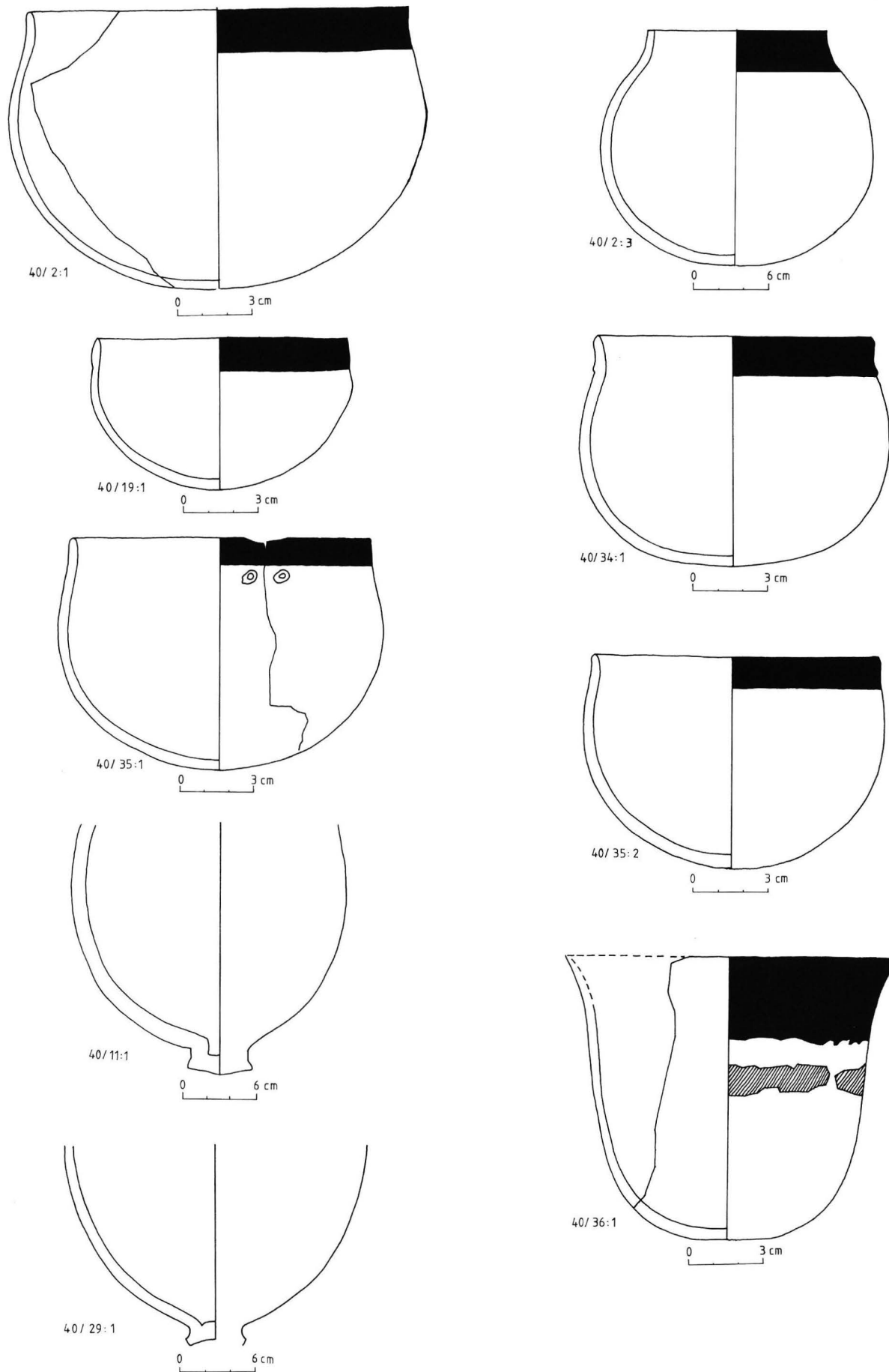

180. Site 40. Ceramic repertoire. **Bowls**: Plain polished red-and-black ware with black-topped variant *H4.11C*, nos. 2:1,3. The ext. black-top confined to a narrow band separated from the body by an incised groove, *H4.11F*, nos. 19:1,34:1. With black-mouthed variant, *H4.11D*, nos. 35:1,2. Kerma-beaker, *H4.15*, no. 36:1. **Qaduses**: Early Christ. brown utility ware, *NU/UI*, nos. 11:1,29:1.

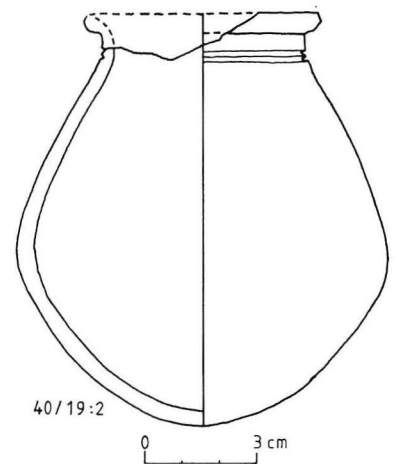
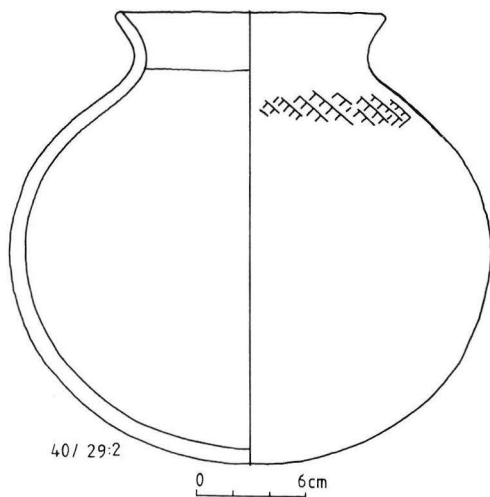
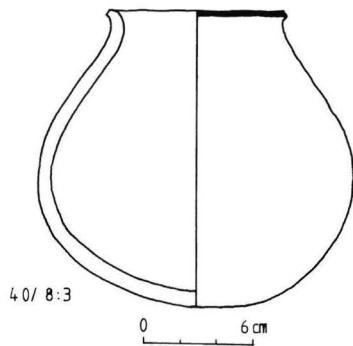
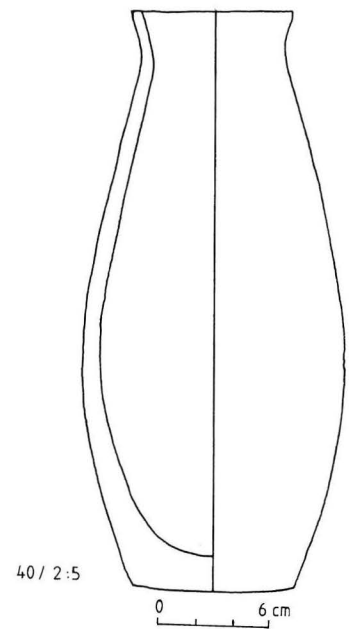
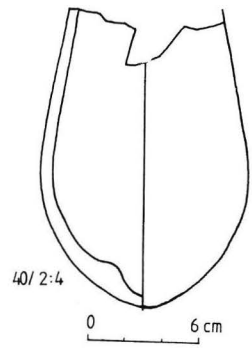
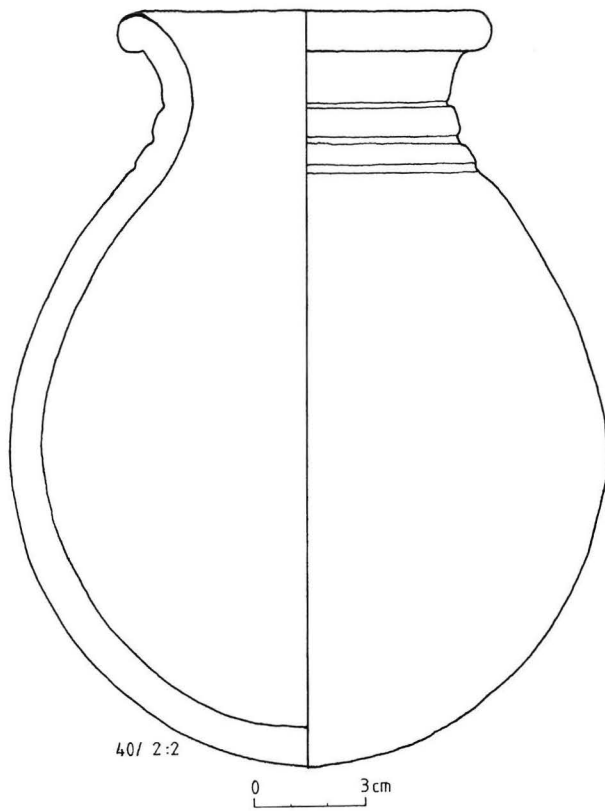

181. Site 40. Ceramic repertoire. **Jars:** brown, red-coated ware with polished ext., *W1.12*, no. 2:2. Uncoated brown, coarse ware, *W1.01*, nos. 2:4,5,8:3. Brown, red-coated ware with polished ext., *W1.12B*, no. 19:2. Earlier Christ. red-topped domestic ware, *DII/H2*, no. 29:2.



1.



2.



3.



4.



5.



6.



7.



8.



9.



10.



11.



12.



13.



14.



15.

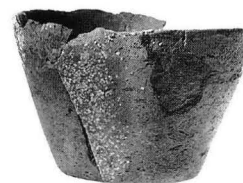

16.

182. Goblets. *NII/R1*. 1-7. 2/145:2,69:3,104:2, 11-I-4/1:1, 54:3,44:1,104:1. *T/R25*. 8-11. 2/73:3,105:1,133:2,157:1. *AI/R30*. 12. 2/186:2. Footed bowls. *NII/R1*. 13-15. 2/140:1,3;157:2. 16. Bowl. 2/158:1.



1.



2.



3.



4.



5.

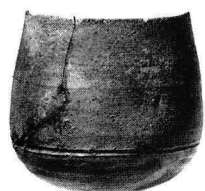

6.

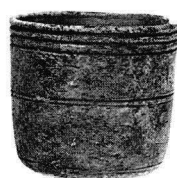

7.

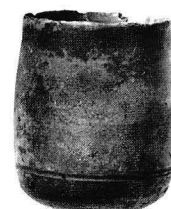

8.



9.



10.



11.



12.



13.

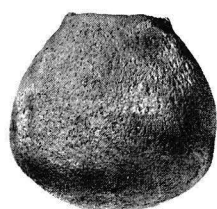

14.

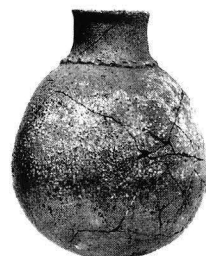

15.

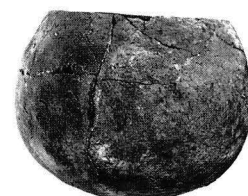

16.

183. **Cups.** *NII/R1*: 1-8. 2/35:2,54:1,81:2,83:3,104:3,150:1, 147A:2,7a. **Pots.** *NII/R2*: 9. 2/105:5. *NU/UI*: 10. 2/59:2. *DI/H1*: 11-13. 2/69:2,147:3,73:2. *DI/H2*: 14. 2/66:3. *DII/H3*: 15. 2/154A:3. *DI/H9*: 16. 2/204:3.



1.



2.



3.

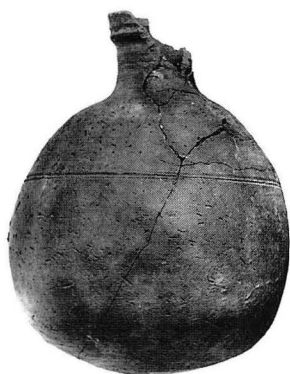

4.

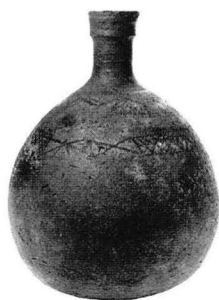

5.



6.



7.



8.



9.



10.

184. Bottles. *NII/R1*: 1-6. 2/35:1,66:2,4;81:1,145:1,154A:2. *T/R25*: 7-8. 2/136A:1,147A:6. *NII/R2*: 9. 2/147A:5. 10. Bronze bowl, X-group (2/205:2, in Khartoum).



1.



2.



3.



4.



5.



6.



7.



8.

185. Pottery. 1. 11-I-4/5:1,1:3,1:2,1:1. Lekythos. AI/R30: 2. 2/80:1. Amphorae. T/R25: 3. 2/217:4. T/W21: 4. 204:2. NII/RI: 5. 2/147A:4. Qaduses. NU/U1: 6-7. 2/202:2,105:2. NU/U5: 8. 2/223:1.



1.



2.

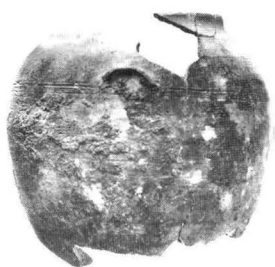

3.

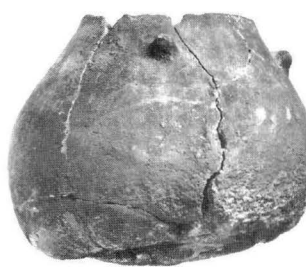

4.

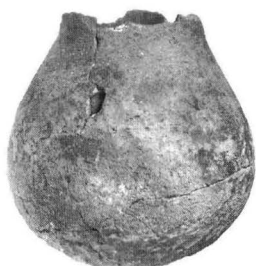

5.

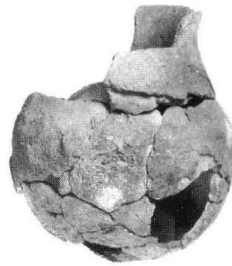

6.

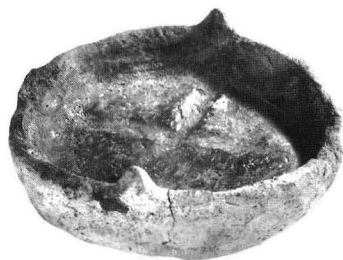

7.

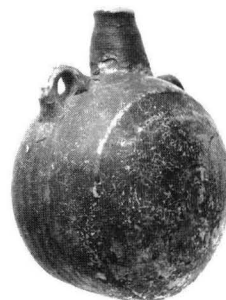

8.

186. Pots. *NU/U14*: 1. 4/2:2. *NU/U10*: 2–3. 4/3:1,20a:1. *DIII/H4*: 4. 4/15:1. *DII/H2*: 5–6. 4/30:1,3:2. Lamp. *DIII/H4*: 7. 4/15:2. Pilgrim bottle. 8. 4/45:1.



1.



2.

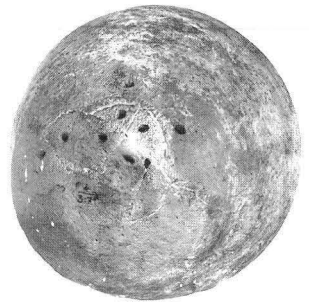

3.



4.

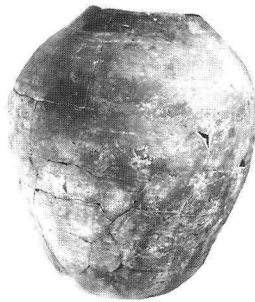

5.



6.



7.

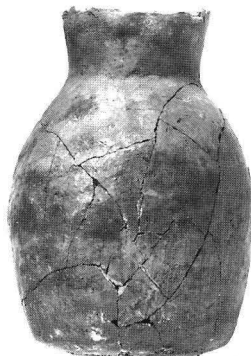

8.



9.



10.

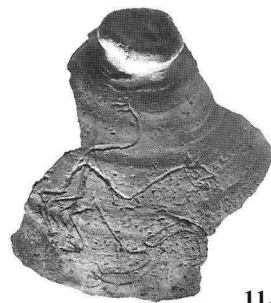

11.

187. Jars. NU/U5: 1. 4/38:1. 2-3. 4/3:7. 4. 4/3:6. NU/U10: 5-7. 4/7:4,18:1,7:2. DIII/H5: 8. 4/29:1. Qadus. NU/U5: 9-11. 4/3:8,3:4,075.

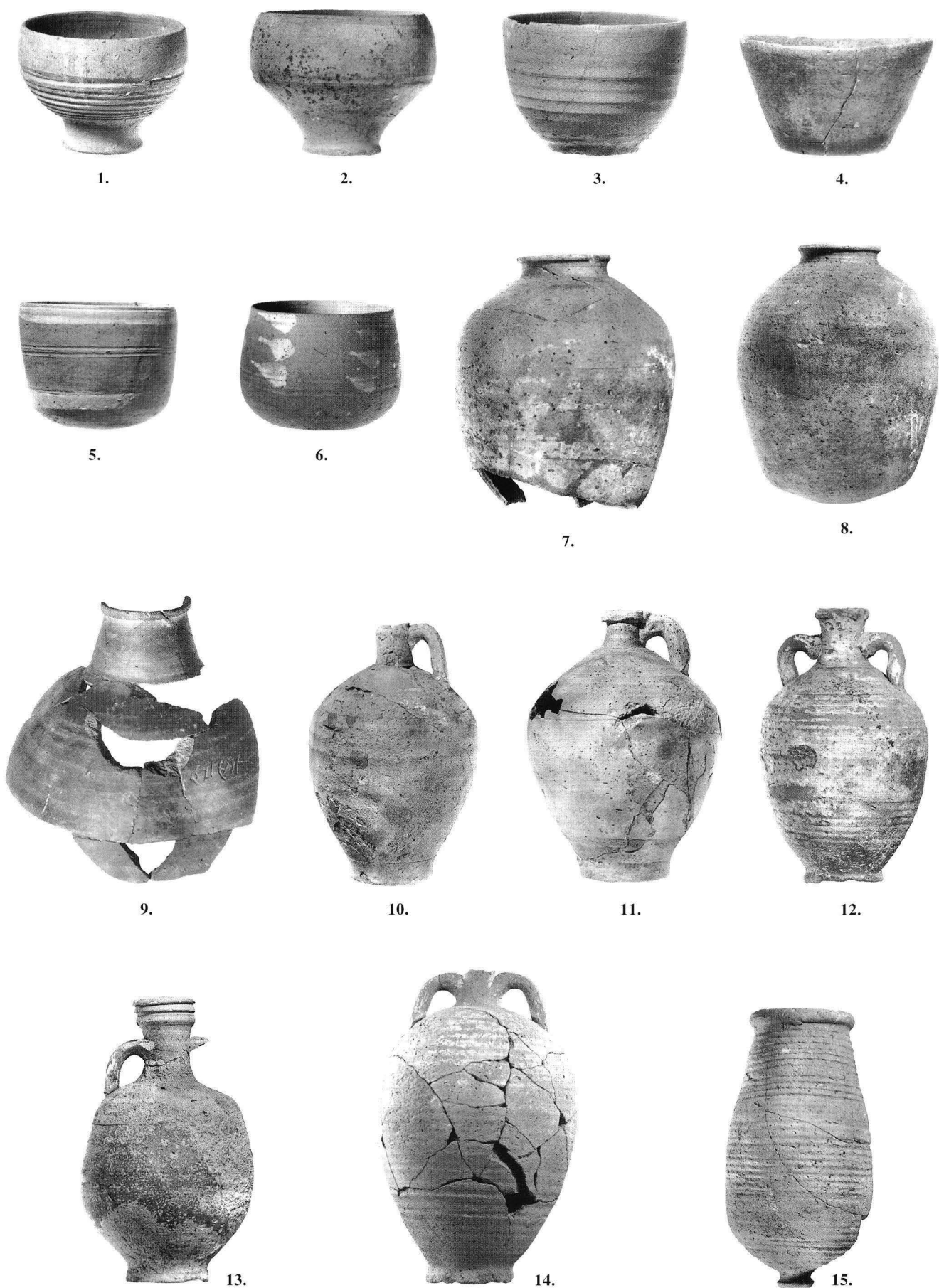

188. **Goblets.** *NII/R1*: 1-2. 5/39:6,40:3. *T/R25*: 3. 5/39:3. **Bowls.** *NII/R1*: 4-5. 5/37:1,40:2. **Cup.** *NII/R1*: 6. 5/40:1. **Pot.** *NII/R1*: 7. 5/29:14. **Bottles.** *NII/R1*: 8. 5/22:1. *NI/R32*: 9. 5/6:2. **Lekythos.** *AI/R30*: 10-11. 5/39:2,5. **Amphorae.** *T/W28*: 12. 5/43:1. *AI/R30*: 13. 5/35:1. 11-D/7/2:1. **Qadus.** *NU/UI*: 14. 5/39:4.



1.



2.

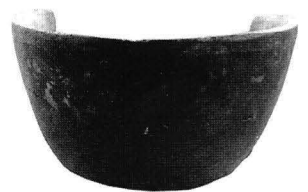

3.

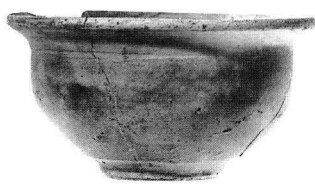

4.

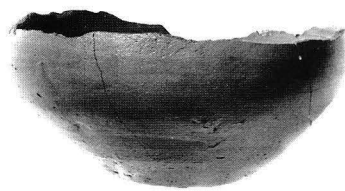

5.

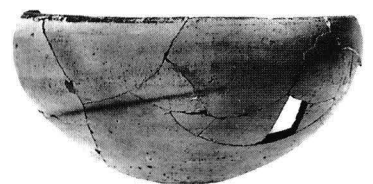

6.

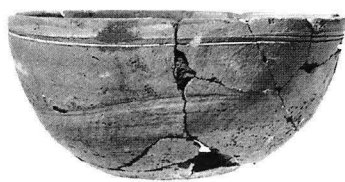

7.

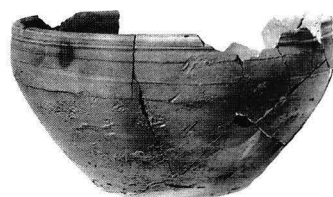

8.

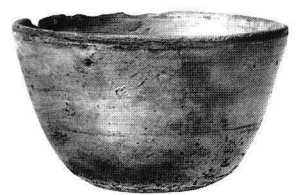

9.



10.



11.



12.

189. Bowls. 1-3. 11-D-4/3:4-6. NIII/W2: 4-8. 6/7:2,9:1,13:1; 12:4,3. Cups. NIII/W2: 9-11. 6/8:4,3,6;10:2.

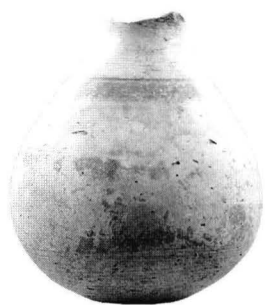

1.



2.



3.

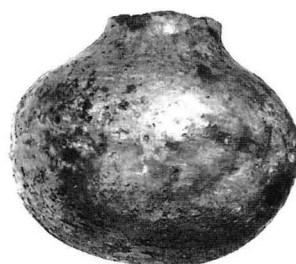

4.



5.



6.



7.



8.



9.

190. Bottles. 1-3. 11-D4/3:3,1,2. *DII/H9*: 4. 6/9:2. *NIII/W2*: 5. 6/8:5. *NIH/R2*: 6-9. 6/8:7,12:2,1;10:3.



1.



2.

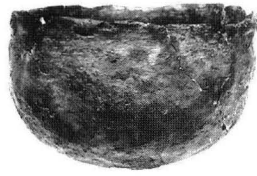

3.



4.

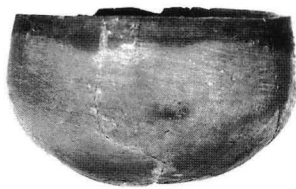

5.

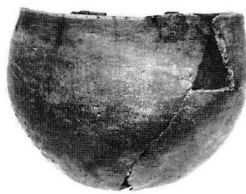

6.



7.



8.



9.

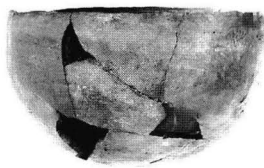

10.



11.



12.

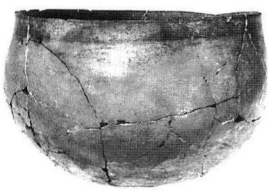

13.



14.



15.



16.

191. Bowls. *H1.01B*: 1. 29/11:02. *H2.01C*: 2. 29/4:02. *H4.11*: 3. 29/12:5. *H4.11C*: 4. 29/11:01. *H4.11D*: 5–10. 29/3:2,14:1, 7:03,14:5,06;12:1. *H4.11F*: 11–15. 29/1:1,5:3,2,01;3:1. Cup. *H1.01B*: 16. 29/07.

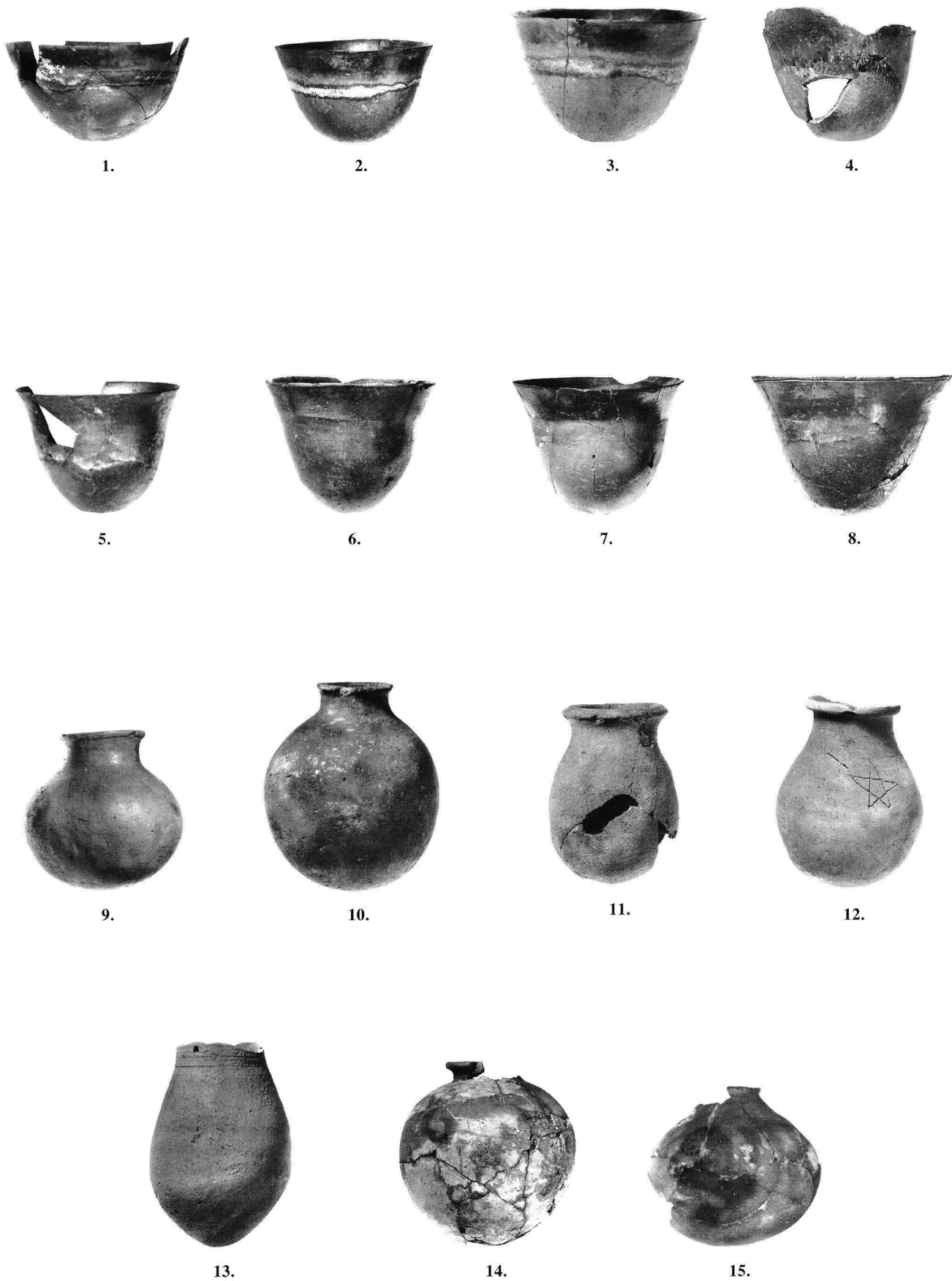

192. Beakers. H4.15: 1-8. 29/7:1,1:3,7:2,14:7;12:6,2,3,4. Jars. H2.13: 9-10. 29/14:2,1:2. H1.01B: 11. 29/14:3. H2.01C: 12. 29/5:1. W1.01: 13. 29/9:2. W1.11A: 14. 29/6:4. W3.22: 15. 29/14:8.

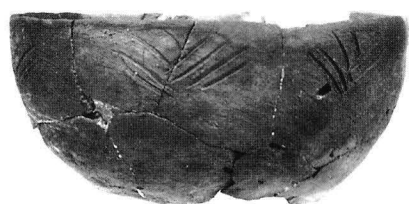

1.

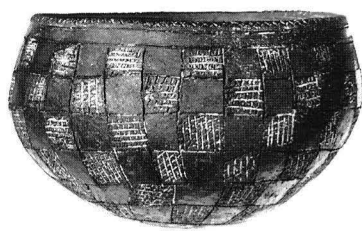

2.

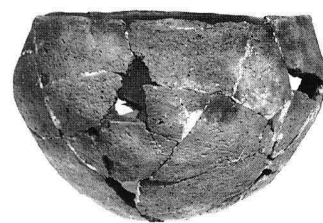

3.



4.

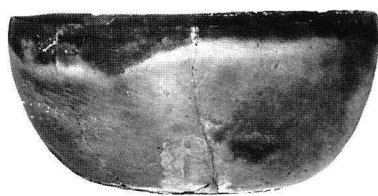

5.



6.

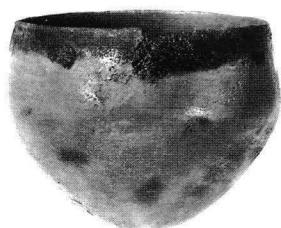

7.

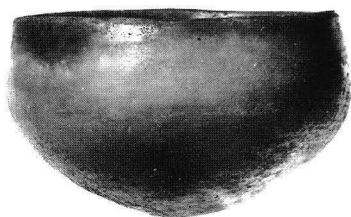

8.



9.

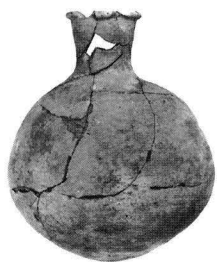

10.

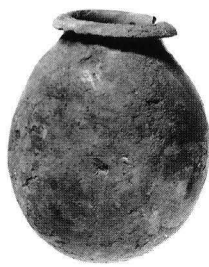

11.



12.



13.

193. Bowls. *H1.01B*: 1. 30/15:1. *H3.03*: 2. 30/16:1. *H4.01*: 3. 30/DIV:01. *H4.11*: 4-6. 30/BIII:01, CII:01, 23:2. *H4.11A*: 7-9. 30/2:3, 2, 1. Bottle. *W3.21*: 10. 30/9:1. Jars. *H2.13*: 11. 30/16:2. *W5.01*: 12-13. 30/FIII:01, 11:1.

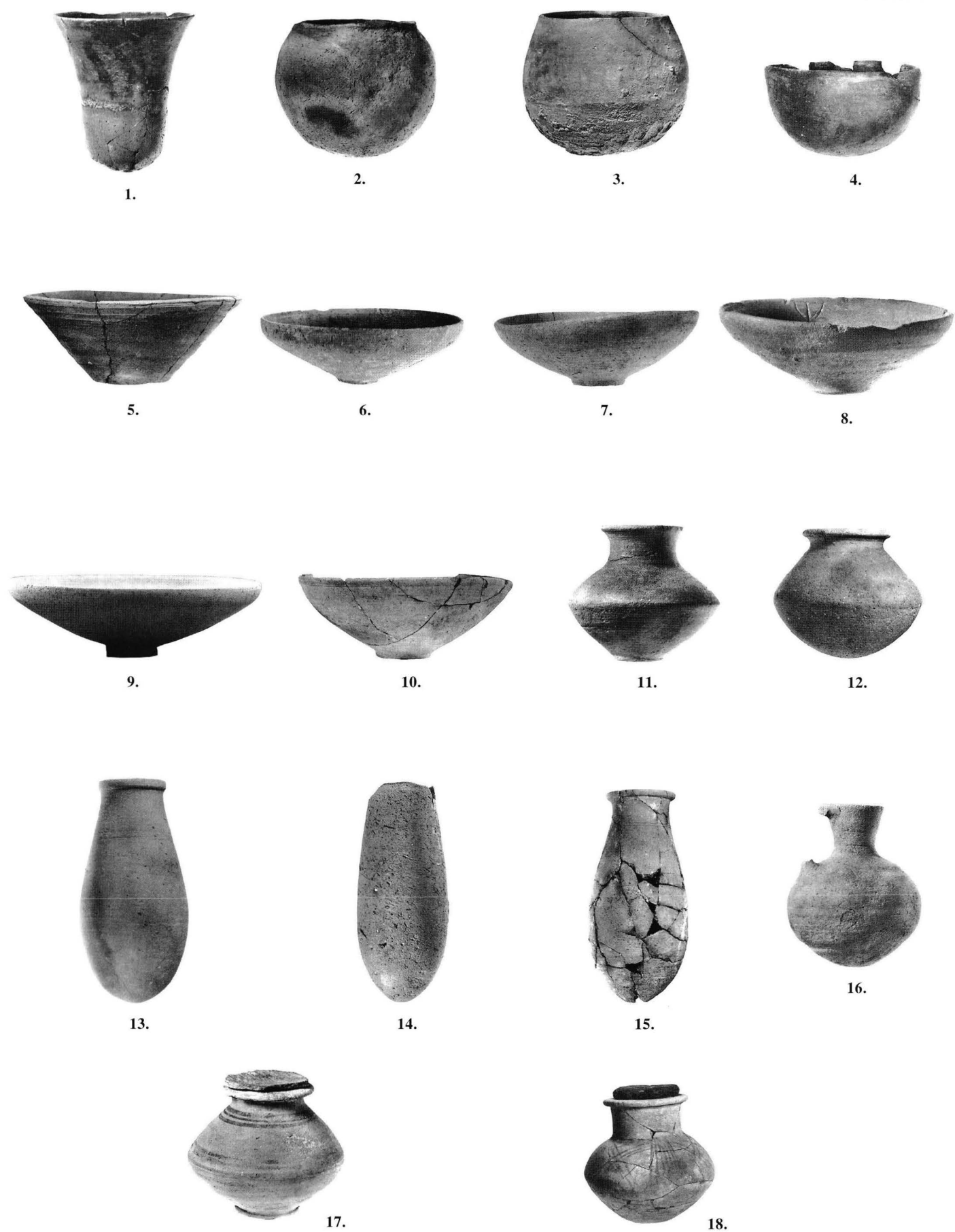

194. Beaker. *H4.15*: 1. 32/4:2. Bowls. *H1.01B*: 2. 32/10:2. *W1.01*: 3. 32/17:1. *H4.11D*: 4. 32/19:2. *W1.01*: 5. 32/6:1. *W1.14*: 6-10. 32/9:1,4:4,11:3,4 (in Khartoum), 7:2. Jars. *W1.12*: 11. 32/4:1. *W1.02*: 12,14. 32/10:4,7:4. *W1.11*: 13,16. 32/10:1,11:1. *W1.01*: 15. 32/4:3. *W3.12*: 17. 32/7:3a,b. *W3.22*: 18. 32/6:2a,b.



1.



2.



3.

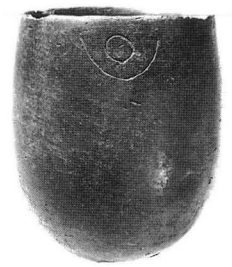

4.



5.



6.

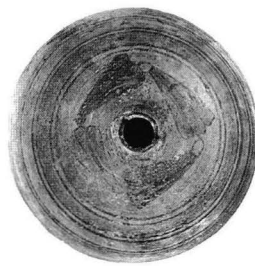

7.



8.



9.



10.



11.



12.



13.



14.



15.

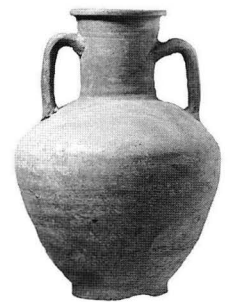

16.

195. **Bowls.** *Pre-Meroitic*: 1. 39/48:1. *DI/H9*; 2. 39/2:3. **Beaker.** *DI/H9*; 3. 39/4:1. **Cups.** *Pre-Meroitic*: 4. 39/10:1. *M/W26*; 5. 39/106:5. **Bottles.** *NI/W25*; 6-7. 39/106:4. *NI/R32*; 8. 39/106:2. **Jars.** *Pre-Meroitic*: 9-10. 39/104:1, 136:1. *DI/H11*; 11. 39/119:3. *AI/R30*; 12. 39/119:2. *Pharaonic?* 13. 39/104:2. **Lekythos.** *AIV/R30*; 14. 39/2:1. **Jug.** *AIV/R30*; 15. 39/1:1. **Amphora.** *AI/R30*; 16. 39/116:2.



1.



2.



3.



4.



5.



6.



7.



8.



9.

196. Bowls. H4.11C: 1. 40/2:3. H4.11D: 2-3. 40/35:1-2. H4.11F: 4-5. 40/19:1,34:1. Jars. H1.01B: 7. 40/8:3. W1.12B: 6,8. 40/19:2,2:2. DIII/H2: 9. 40/29:2.



1.



2.



3.

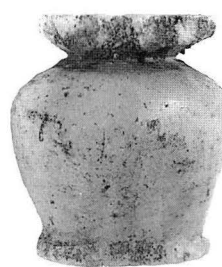

4.

197. Bowl. H4.11D: 1. 44/2:1. Jars. W3.2I: 2-3. 44/2:2,3:1. Kohl-pot. 4. 44/2:3.

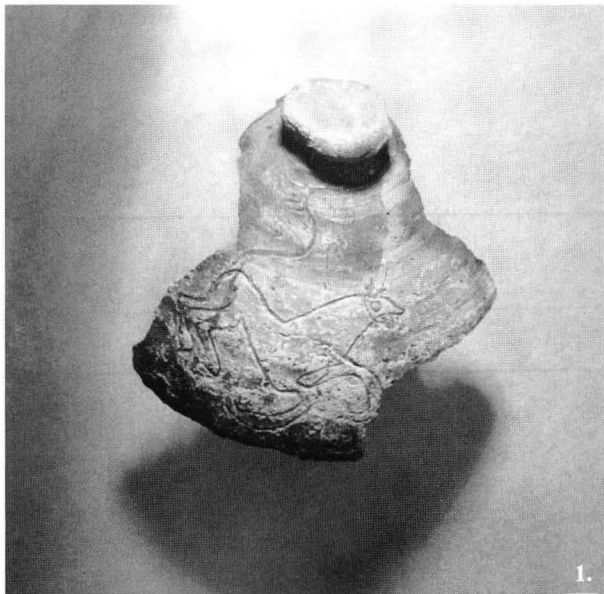

1.

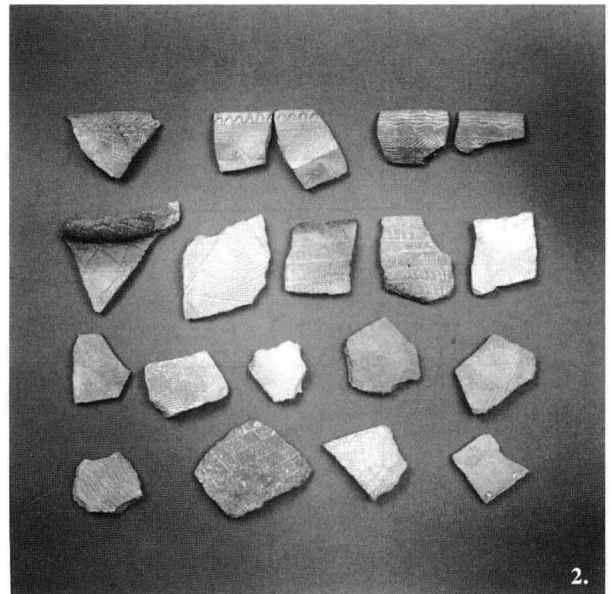

2.



3.



4.

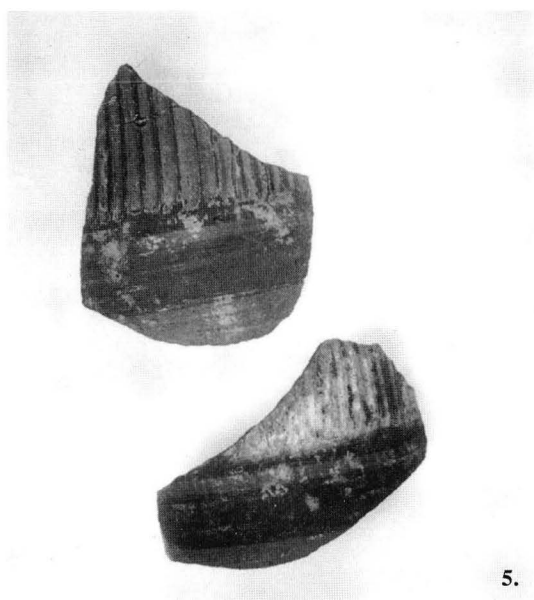

5.



6.

198. 1. Base knob (4/075). 2-3. Sherds. Decoration motifs of C-group pottery. 4. Kerma-beakers. 5. Sherds of painted jar of NK type (15/10). 6. Pre-Meroitic jar (39/136:1).

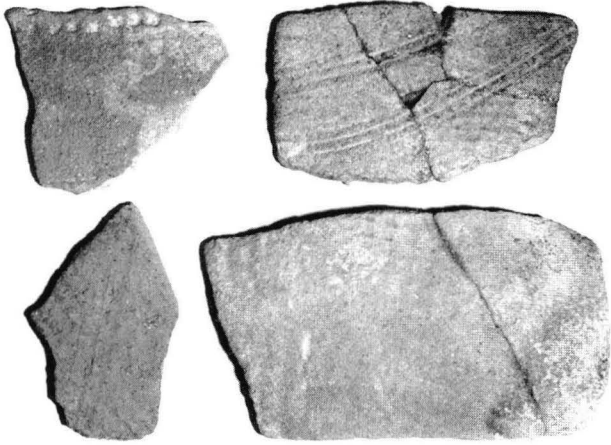

1.

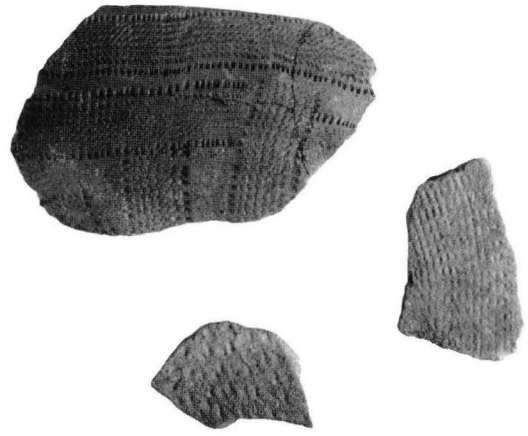

2.

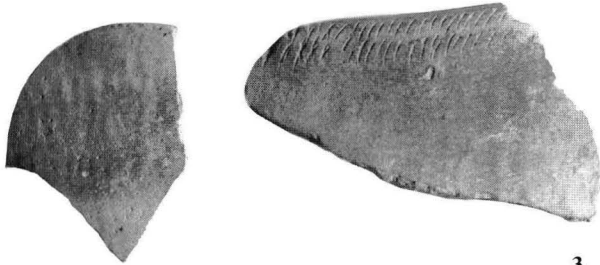

3.

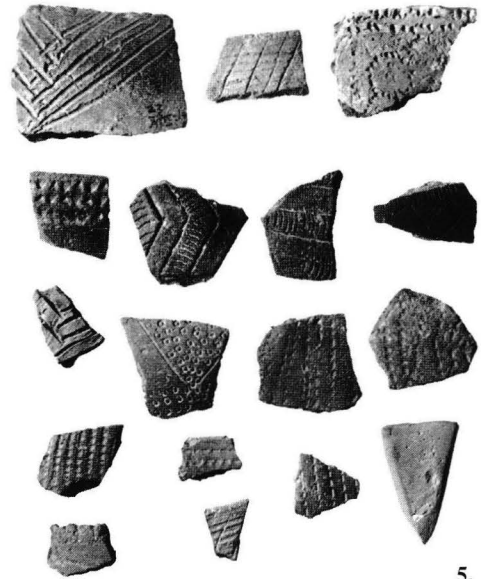

5.



4.

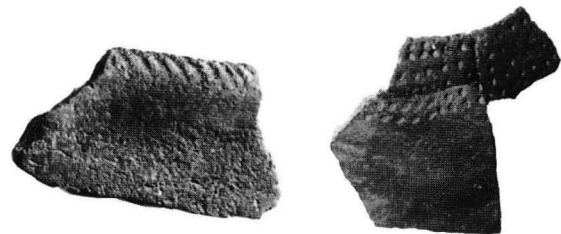

6.

199. Sherds. 1–2. Early-Khartoum, K1.01 (43). 3. Es-Shaheinab decoration in A-group pottery (43). 4–6. Incised decoration motifs of C-group pottery.

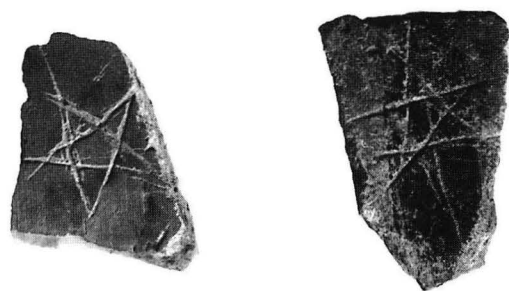
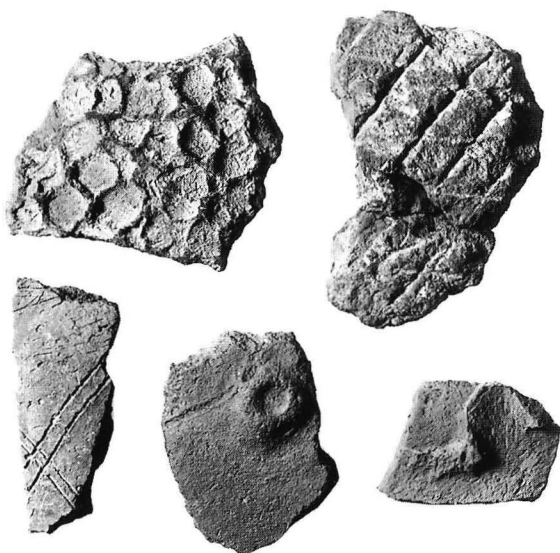

200. Sherds from Christian period (sites 1,4,8,28).

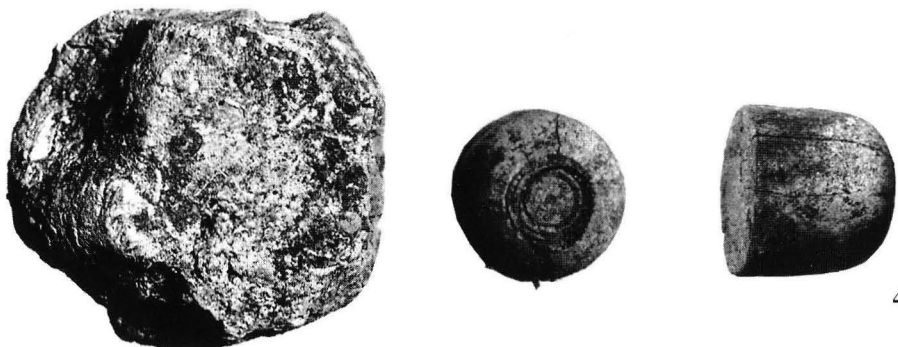
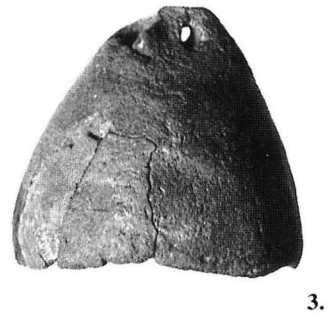

201. 1. Glass sherds 4/010-012. 2. Seal and a smink-jar 4/8:1, 40/10:6. 3. A clay bell 1/01. 4. Jetons 2/154A:15,11.

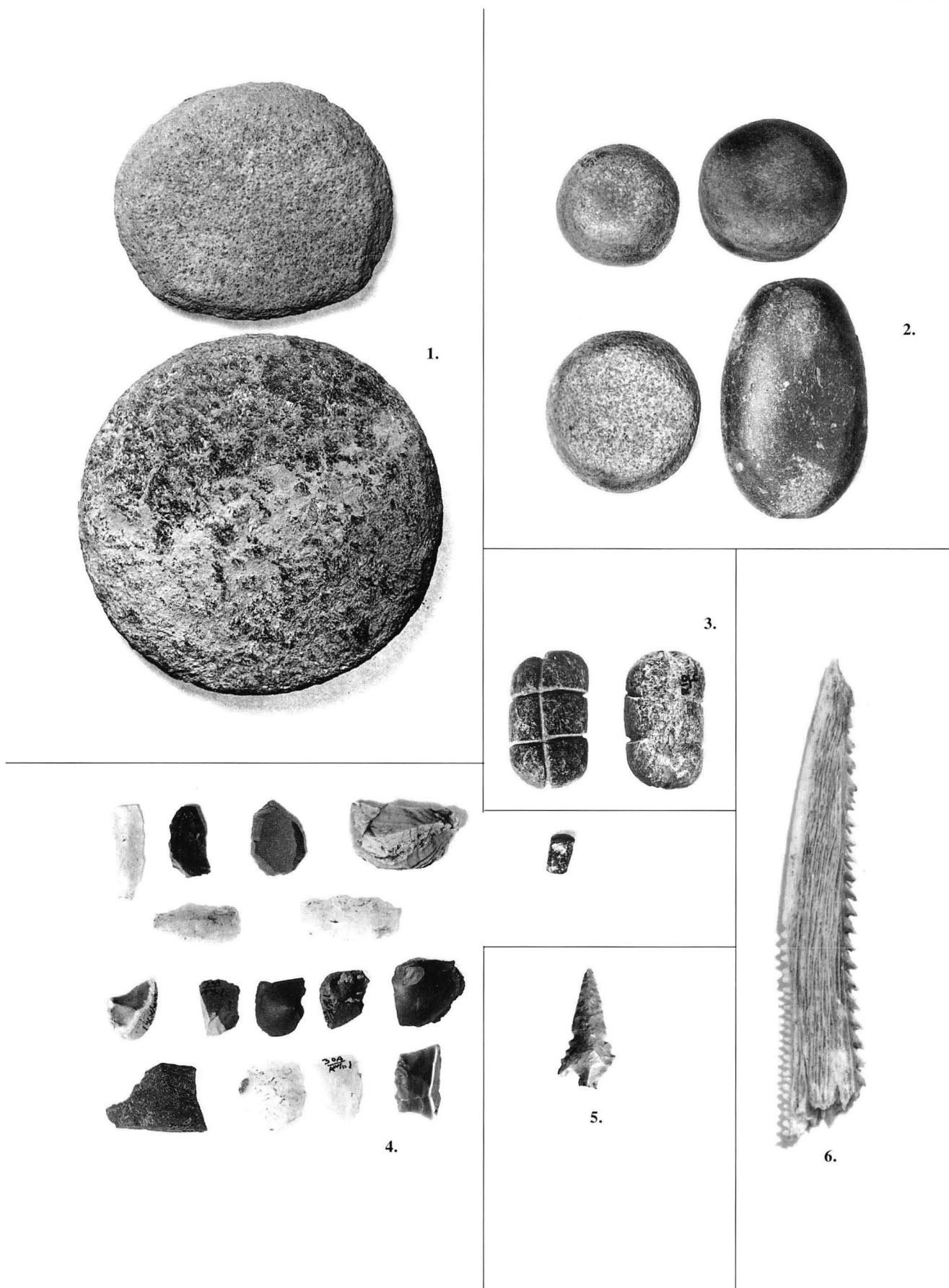

202. 1. Grinders 43/FVI:3, FVII:f:1. 2. Clubs 4/01,3:10, 30/DIV:02, 4/30:3. 3. Tool? Soapstone 4/018,019. 4. Flakes 30A/IV:II:1. 5. Arrowhead, flint 32/7:01. 6. Bone tool (30A/AV:I:1).



1.



2.

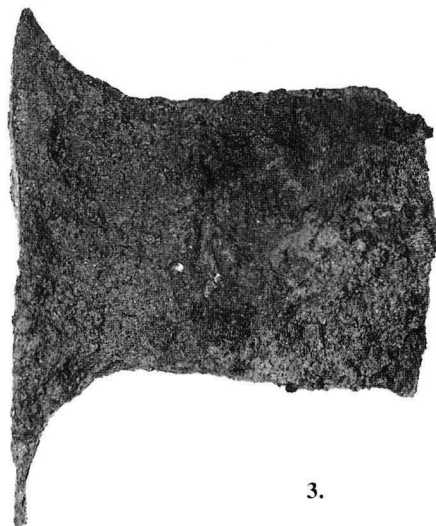

3.

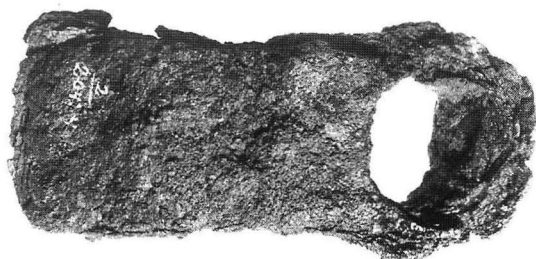

4.

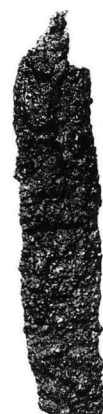

5.

203. 1. Iron spoon 39/114:4. 2. Bronze hook 29/14:4. 3,5. Axes and a knife 39/80:3,1,2,4. 4. Hoes 2/204:4,5.

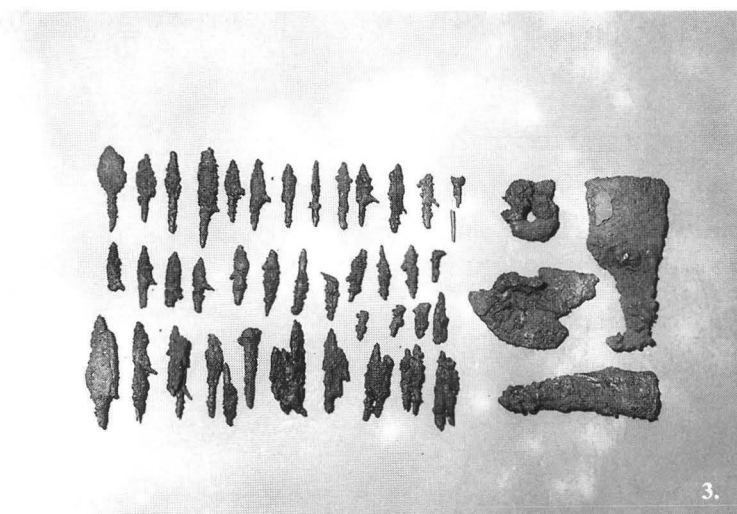
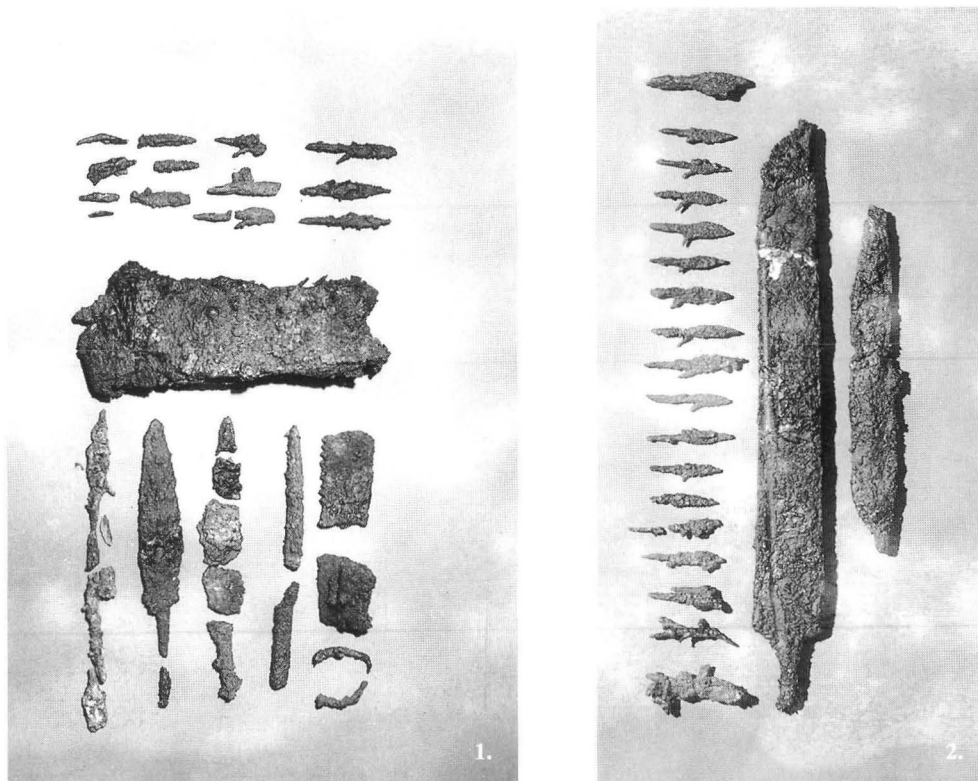

204. 1. Arrowheads, hoe, saw, knives 2/206:2,3;217:2,39;3,4. 2. Knives and arrowheads 2/216:2,3,5. 3-4. Arrowheads 2/214:2,3;204:6.

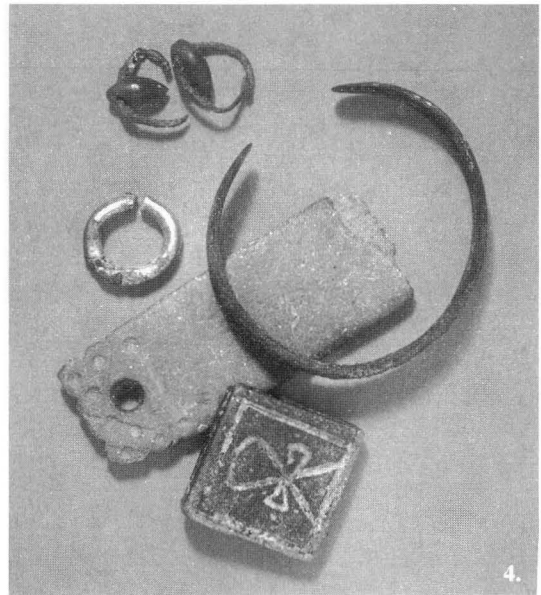
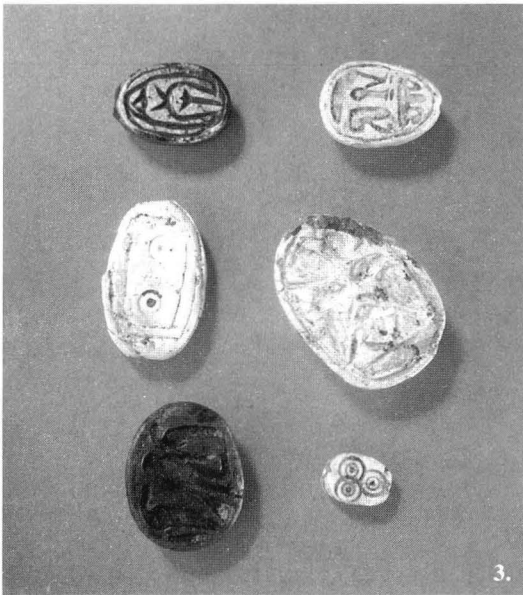
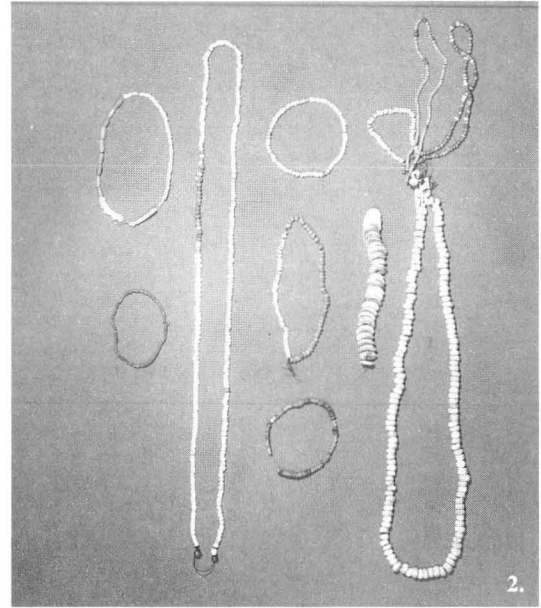
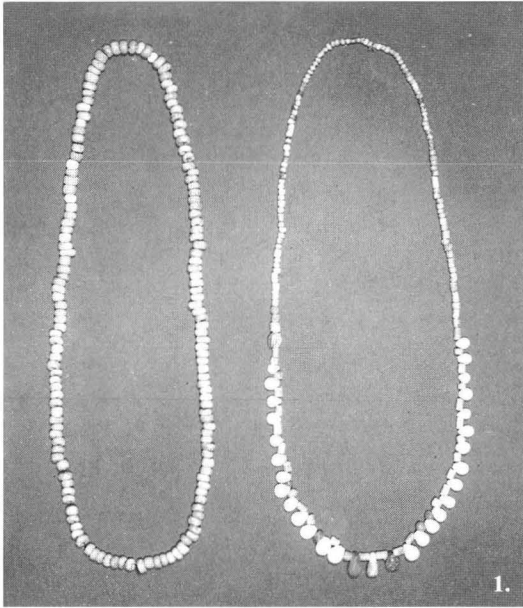

205. **1–2.** Necklaces and bracelets (2/202; 5/23; 39/33,141; 40/35). **3.** Scarabs (5/29:10; 32/7:5a; 2/145:5; 4/9:2a; 41/1:1; 39/48:9). **4.** Earrings (2/202:4; 32/10:3b), bracelet (39/81:1b), plate (39/5:1), tool? soapstone (4/03). **5.** Anklets (5/29:1,13), hoe and arrowheads (2/204:4,6).



1.



2.



3.



206. Necklaces. 1. 39/33:1,119:6,126:1,141:4. 2. 5/40:4,13:1. 3. 40/35:6,3. 32/7:5.

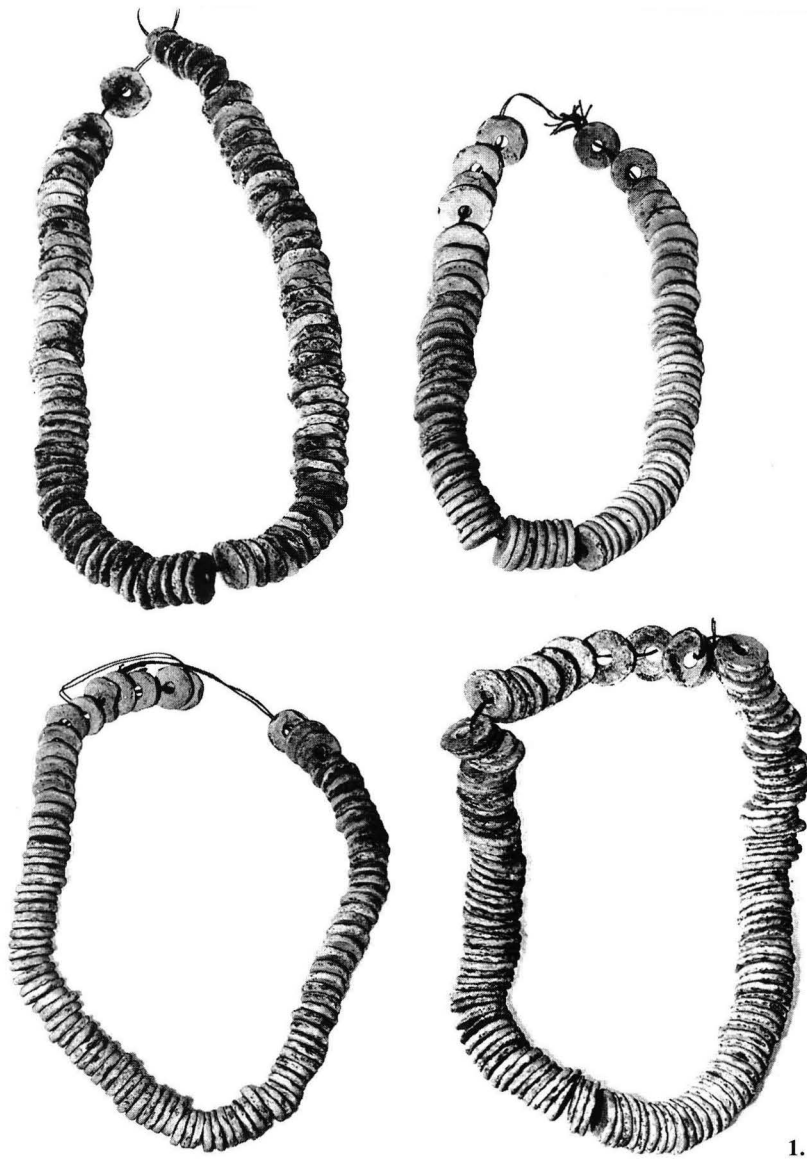

1.

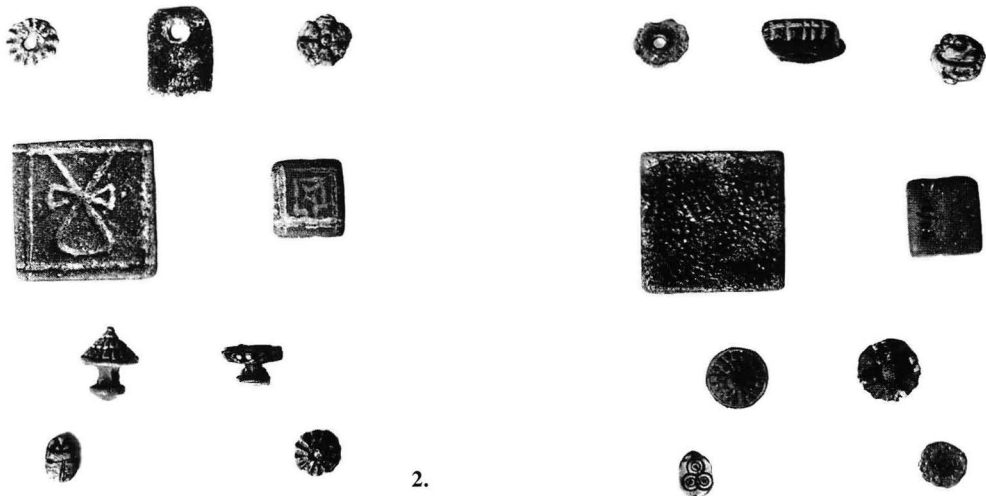

2.

3.

207. 1. Bracelets (5/23:3,5,6b,6c). 2-3. Buttons and pendants (5/3:1; 29/6:6a; 32/10:6; 39/5:1,31:1,114:3a,5; 40/35:5; 41/7:4).

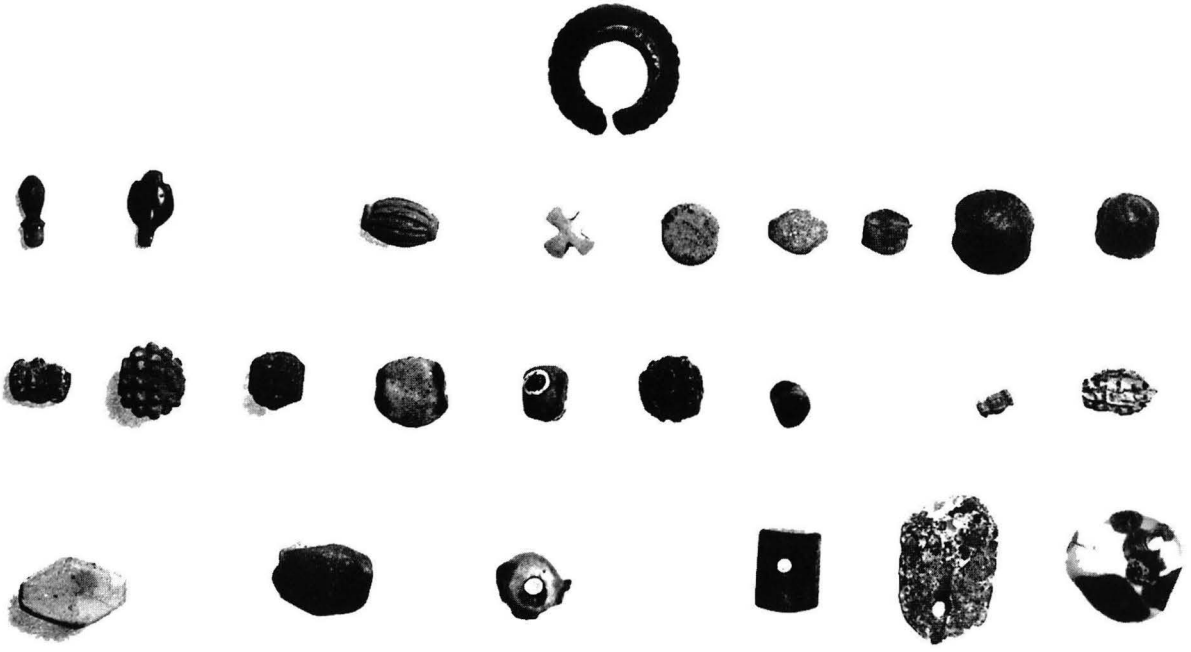

1.



2.

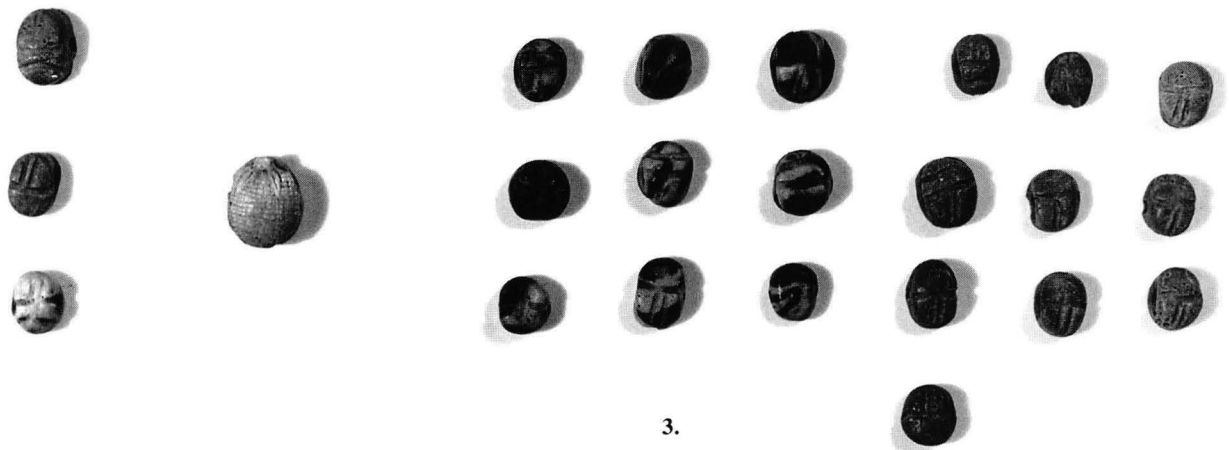

3.

208. 1. Earring, pendants, plates and beads. 2. Ring beads (2/154A:1r). 3. Scarab beads (39/114:2a,b,c,3z).



209. 1. Scarab 32/7:1. 2. Pendant 32/19:1. 3. Dice 2/154A:4, pendant fish 44/2:4. 4. Smink-stick 39/113:1,114:3ö. 5. Bronze coin, Abdul Megid 1255 AH, 1/0121. 6. Beans, date stone and date 4/46-47:1.



1.



2.



3.



4.

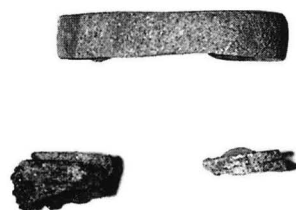

5.

210. Anklets and a bracelet (ivory) 1–3. 5/29:13; 39/64:2; 5/29:1,39:10; 40/30:1; 30/22:1; 39/64:1. 4. Toerings 5/39:8–9. 5. Bracelet and rings 39/81:1b; 2/154A:7,139:5.

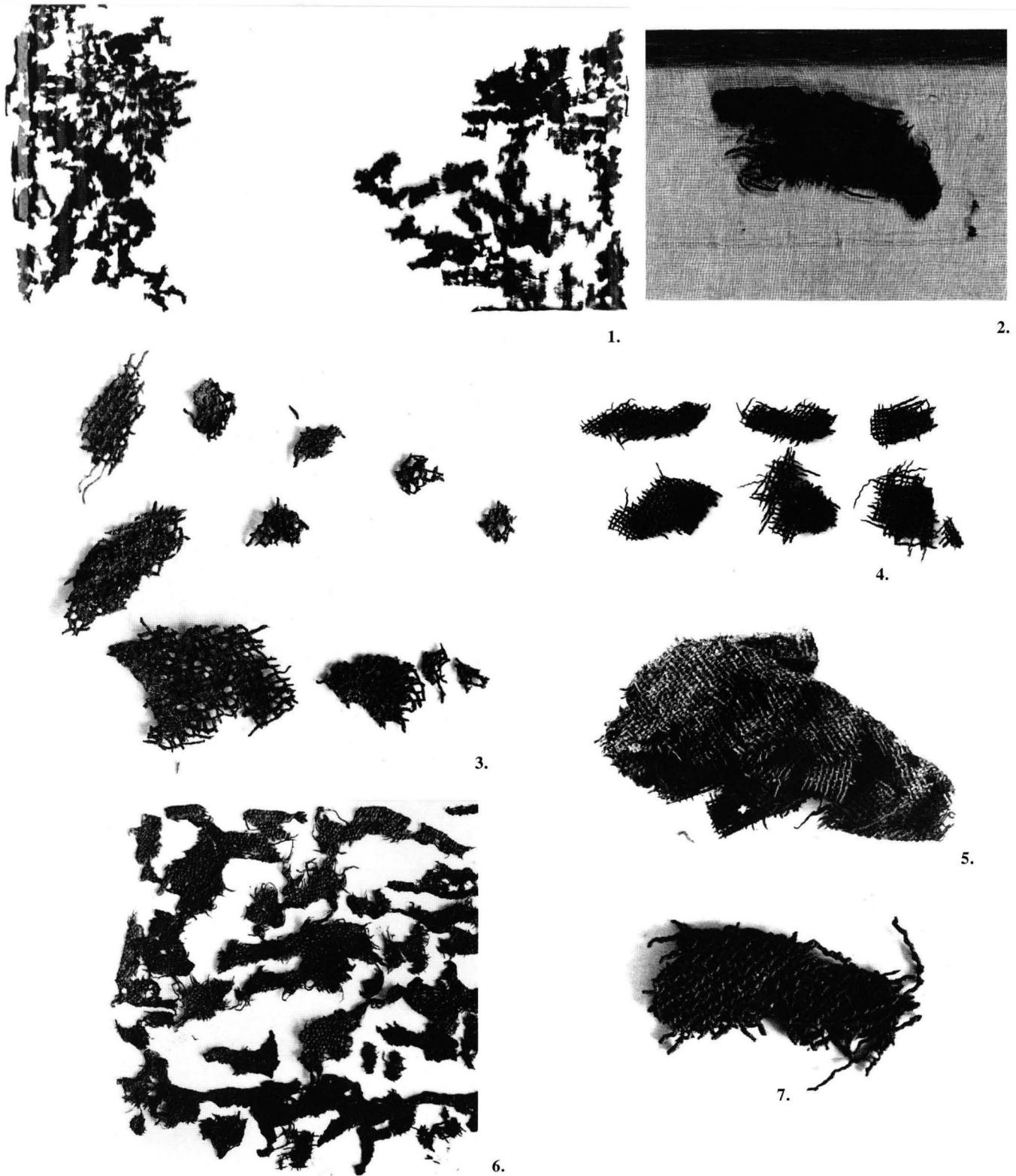

211. Fragments of textiles. 1. A polychrome textile wrap (15/2:1). 2. A detail 15/2:1. 3. Linen garment or mat (39/48A:5). 4-5. Coarse, brown, linen shroud (5/12:1, 15:2). 6. Shroud (1/1:1). 7. A detail (2/100:02).

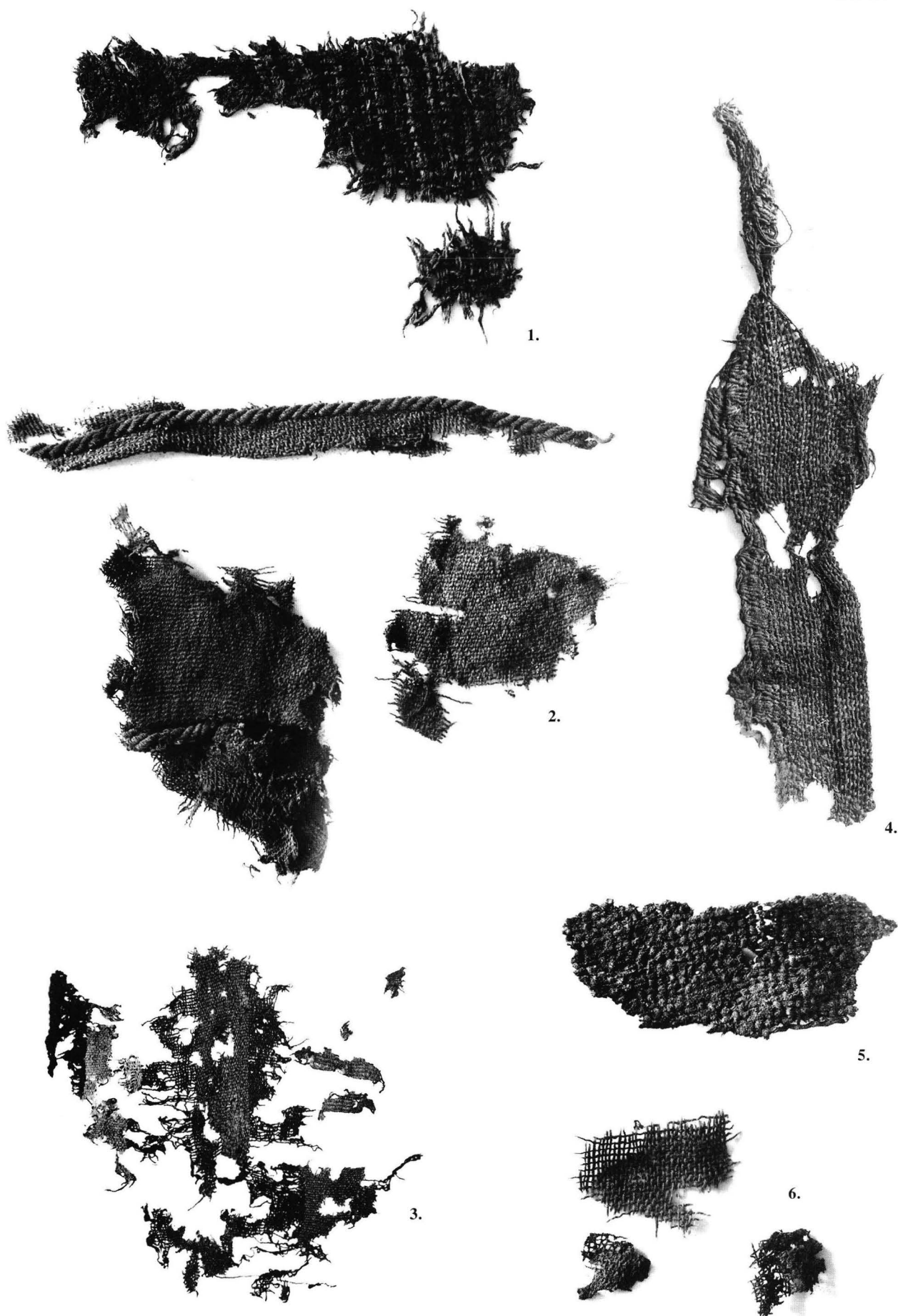

212. Fragments of textiles. **1.** A polychrome woolen mat, rug-type, both ends with twined fringe (6/4:1). **2,4.** White woven linen shroud (6/4:2,8:9). **3.** White woven linen shroud, with broad blue or green woven stripes (6/6:23). **5.** Outer shroud, thin polychrome, striped linen (6/9:3a). **6.** Inner shroud, coarse white linen (6/9:3b).



1.

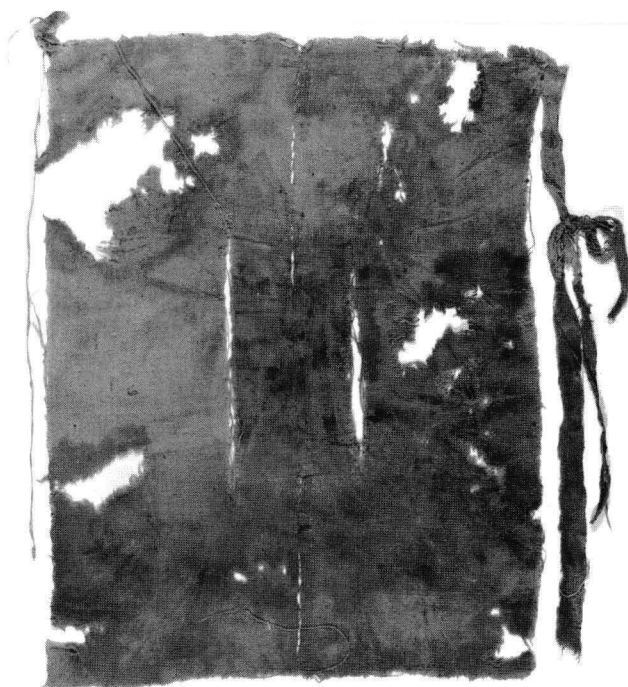

3.

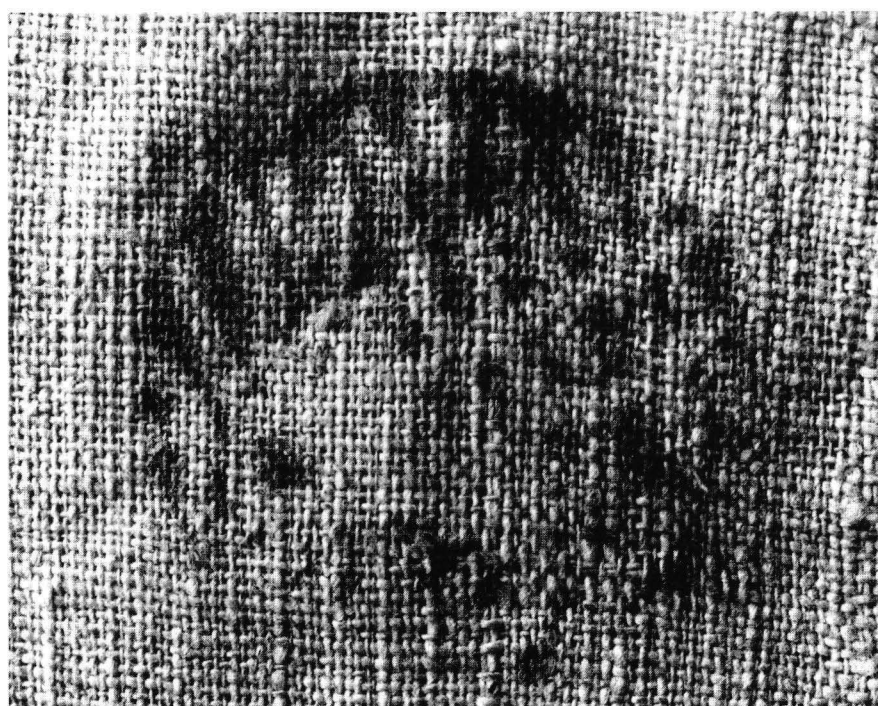
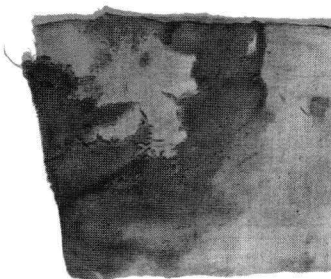

2.

213. 1. A wrap of coarse cotton (14/2:2). 2. A detail, the factory stamp on the damūr (14/2:2). 3. A loincloth and a pillow or a face covering, cotton (14/2:1,3).

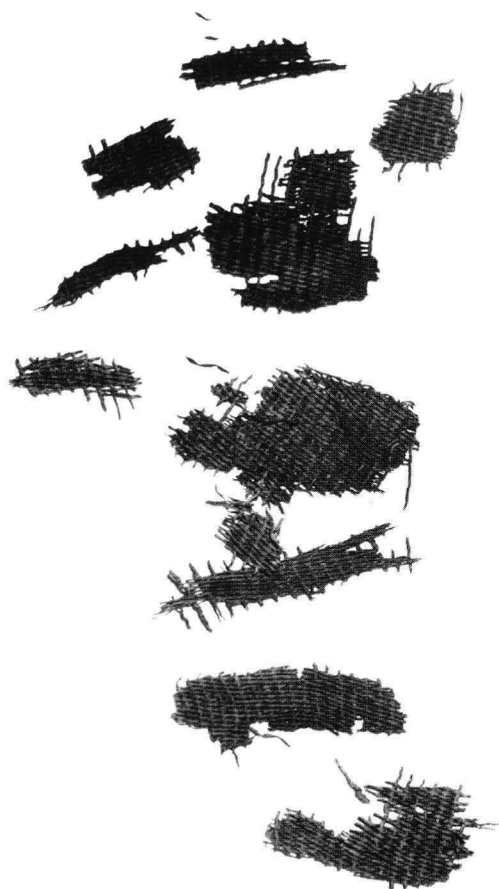

1.



2.



3.



4.

214. 1-2. Fragments of linen shroud (10/4:2,6:1). 3. A detail of wool with brown and beige stripes and fringe with linen stripe knotted (17/1:1). 4. Leather fragments of a small goat or sheep (44/3:3).



1.



2.

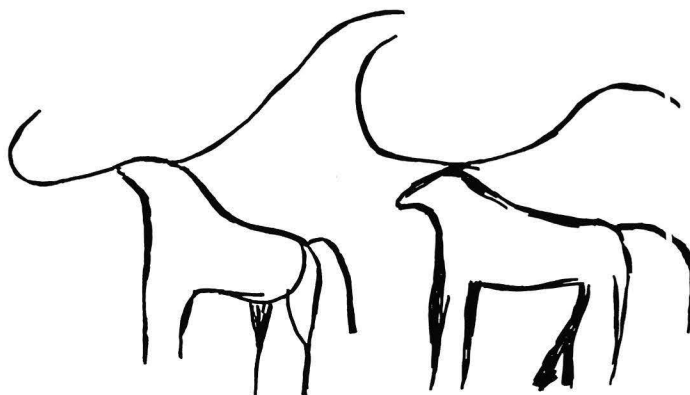

3.

215. Rock drawings. 1. Site 7. 2. Site 35. 3. Site 37.

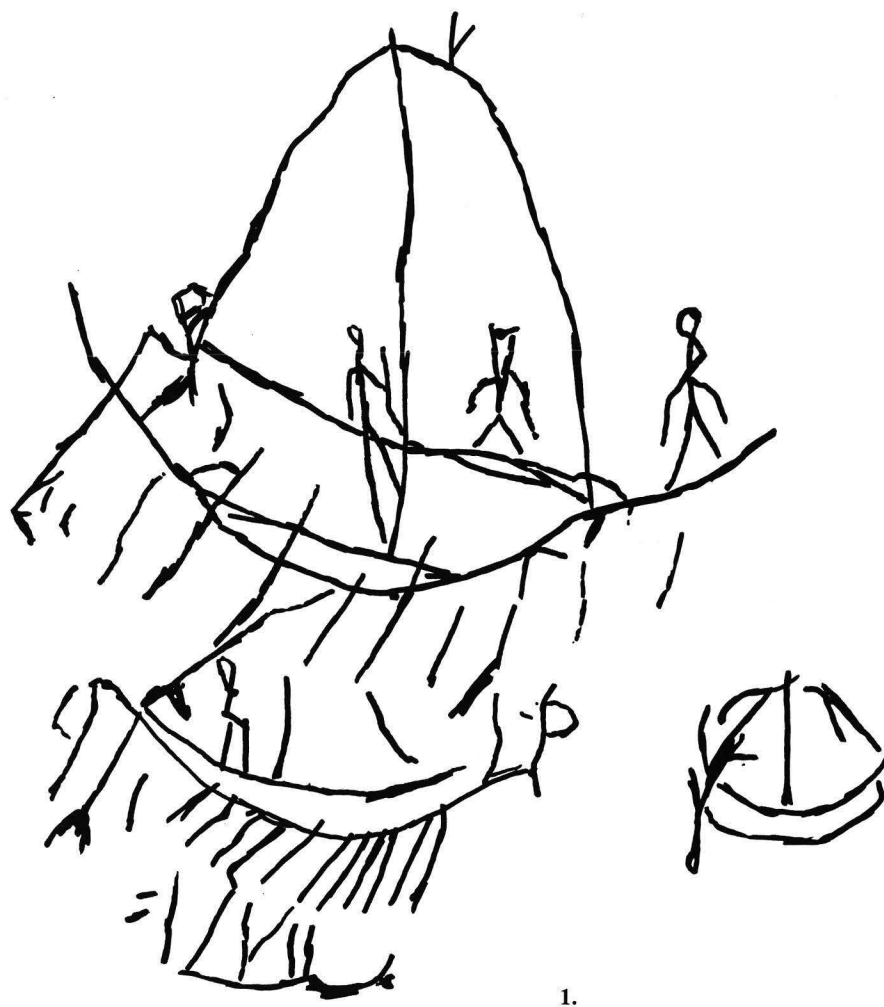

1.

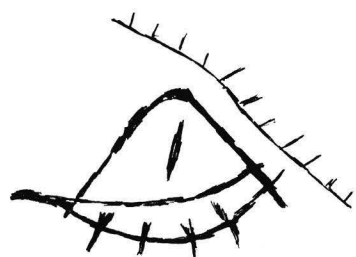

2.



3.

216. Rock drawings. 1. Site 46. 2. Site 47. 3. Site 49.

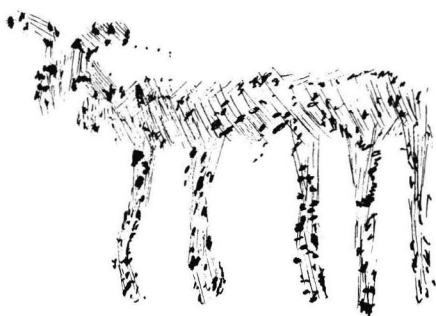

1.



2.

217. Rock drawings. 1. Site 50. 2. Site 51.



1.



2.



3.



5.

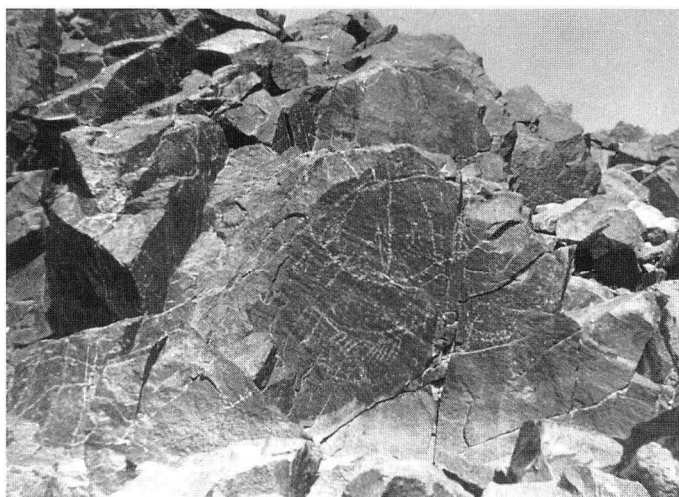

4.

218. 1. The valley of the rock drawings. 2. Site 35. 3. Site 7. 4. Site 46. 5. Site 37.



1.



2.



3.

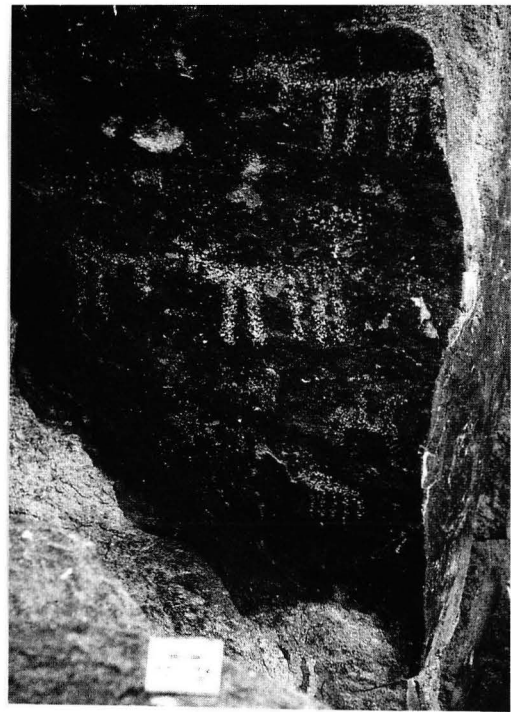

4.

219. 1. Site 47. 2. Site 49. 3. Site 51. 4. Site 50.